

Your partner for
Innovative connections

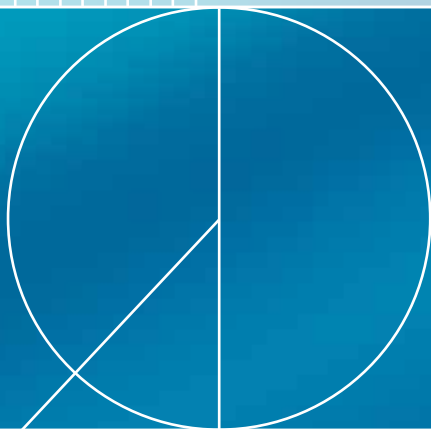

NORMA® DISTRIBUTION SERVICES

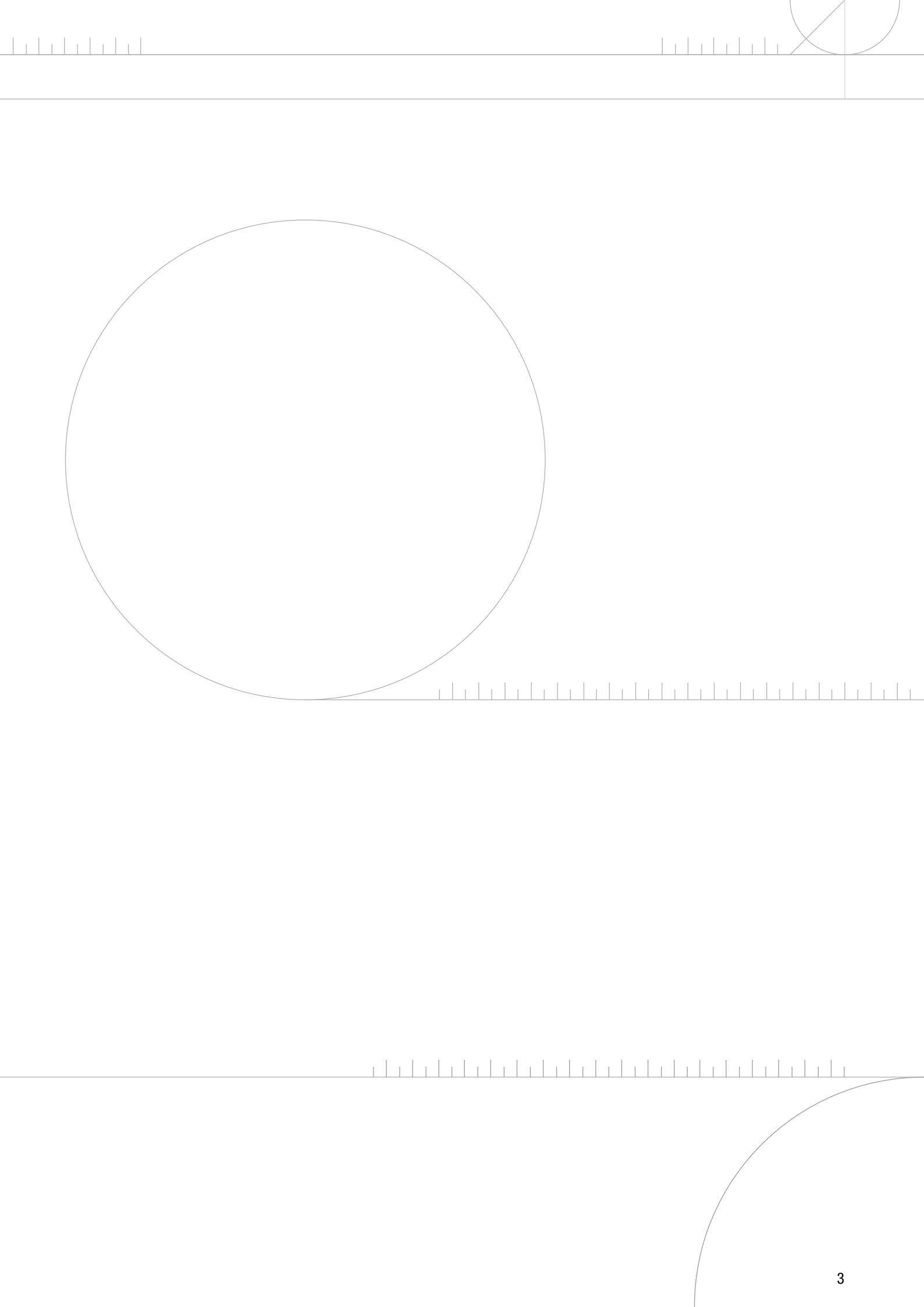



NORMA® – Your partner for innovative connections



Naturally – **you demand the best**

Wherever in the world you are, and whenever you need superior clamping products, there is always one of our products for your first choice.

For over sixty years we have been dedicated to working closely with suppliers and customers to develop products that boast outstanding functional performance. We enjoy support from dedicated employees, all of whom have the goal of exceeding the expectations that customers bring us on a daily basis.

Hose clamps, pipe connections, retaining products or plastic products. Regardless of its use, every NORMA brand product is designed, produced and delivered within the framework of a certified quality-management system. This development procedure is essential for achieving the innovative yet robust designs demanded by end-users.

Our distribution partners rely on both the quality we offer and our cooperation and support. Quality has always been and remains our hallmark.

About **NORMA Group**

NORMA Group is a global market and technology leader with strong growth prospects in attractive niche markets for engineered joining technologies.

The company manufactures and sells a wide range of high-quality engineered joining technology solutions in three product categories: clamp, connect and fluid. These are often mission-critical for the performance, reliability and quality of the respective customer end products.

Headquartered in Maintal, Germany, NORMA Group has a global network, which includes 19 manufacturing and distribution facilities as well as ten sales and distribution sites across Europe, the Americas and Asia Pacific. The company offers more than 30,000 high-quality products and solutions to approximately 10,000 customers in a wide range of industries, including agricultural machinery, commercial vehicles, construction equipment, engines, aviation, infrastructure/construction/water management, passenger vehicles, railway, white goods, wholesalers and technical distributors.

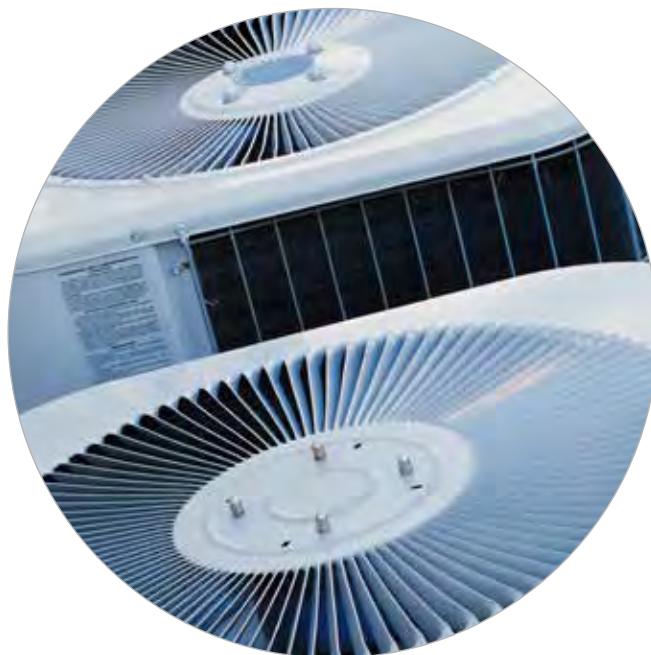

NORMA Group distributes its products in more than 100 countries using two distinct ways-to-market: Engineered Joining Technology (“EJT”) and Distribution Services (“DS”). In the EJT way-to-market, NORMA Group delivers customized, engineered solutions meeting the specific application requirements of original equipment manufacturers. In the DS way-to-market, the company sells a wide range of high-quality standardized engineered joining technology products for a broad range of applications through various distribution channels under its well known brands ABA®, BREEZE®, NORMA®, R.G. RAY®, Serflex®, Serratub®, TERRY® and Torca®.



NORMA® Quality



For NORMA Group quality is an all-embracing value, ranging from product design to delivery and beyond, to cover all aspects of the group's activity including its service to customers.

Regardless of the sector in which a NORMA product is to be used, that product will be designed, produced and delivered within the framework of a TS 16949 certified quality-management system developed for the critical demands of the automotive industry. An impeccable development procedure is essential to achieving robust designs and delivering optimal product quality.

Within this context, Advanced Product Quality Planning (APQP) and associated quality tools such as Failure Mode and Effect Analysis (FMEA) are all fundamental to the development of reliable parts and error-proof production processes. Checks carried out during production are in accordance with control plans and best performed automatically, removing operator influence. NORMA's production lines are mostly automated, as befits a Group in the forefront of its industrial sector.

Teamwork and **Superior products**

“The high quality of our products, solutions and services relies on the close collaboration with our customers.”

At NORMA, teamwork is a decisive watchword, ensuring, for example, that workshop operators and engineers combine their very specific experience and work together on product design and production practicalities. In order to meet customer delivery schedules, Production and Logistics work in close collaboration, ensuring on-time delivery of materials from sub-suppliers. NORMA's careful attention to these factors – and indeed to all aspects of quality – contributes to the all-round excellence for which the Group is known. In addition, NORMA's products are nothing less than remarkable, from a performance and reliability point of view, offering technical solutions that are among the leaders of the industry.

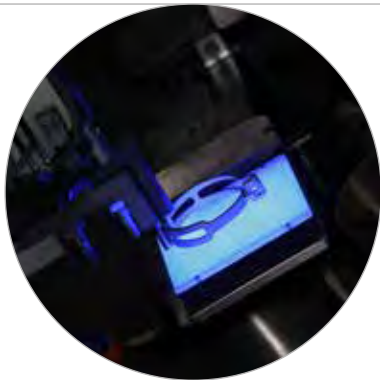
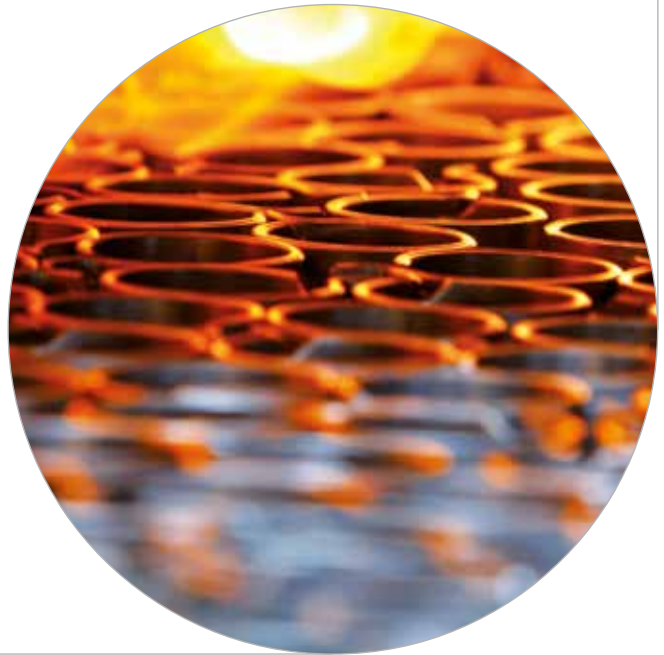

A spirit of **partnership**

Just as product development requires good dialogue between NORMA and its customer, so quality performance during production and delivery involves the closest communication. Besides the internal tracking system with which NORMA monitors and analyzes its own performance, the Group applies so-called “8D” methodology to production-phase problem solving, liaising closely with the customer in a spirit of transparency.

Continually striving to improve quality, delivery and service performance, NORMA aims to remain a market leader through its solutions, maintaining a benchmark level that customers can rely on.

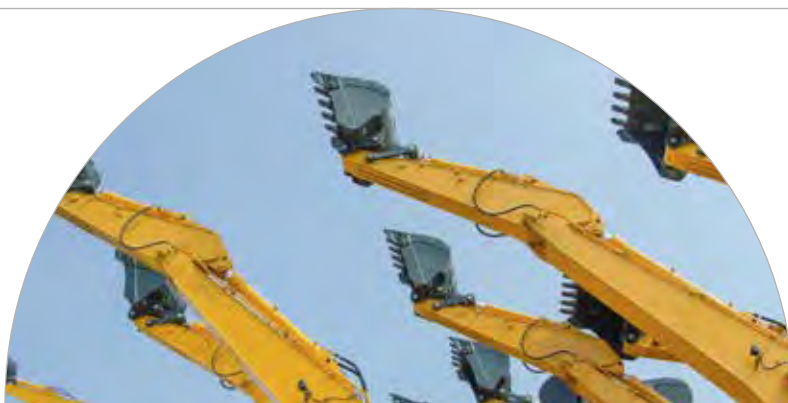

Product development – a creative partnership with customers

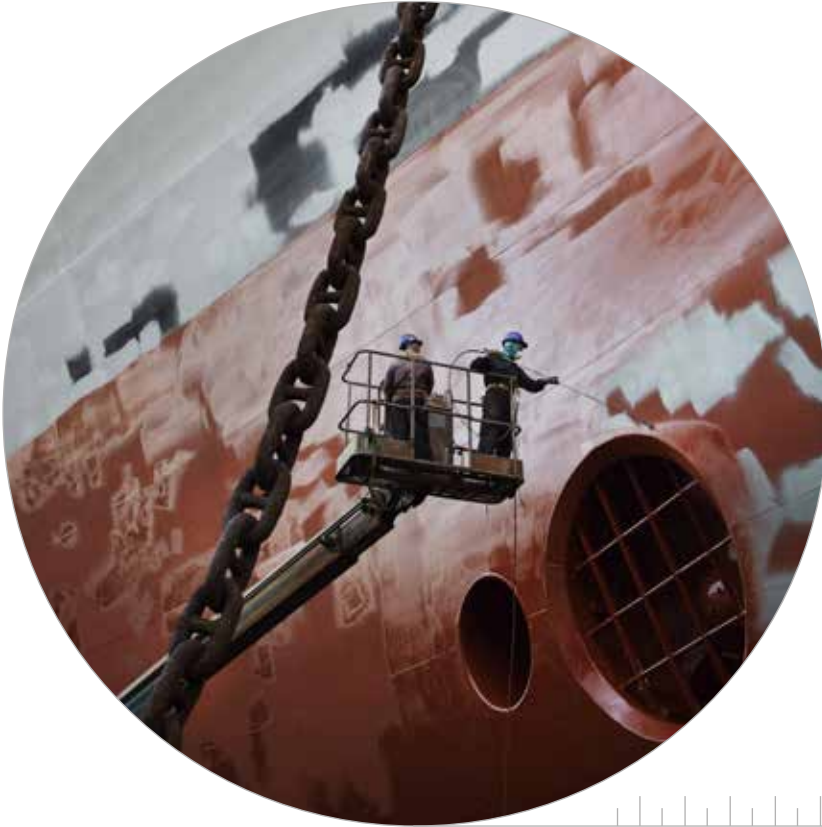

As the leading solution provider in its sector, the NORMA Group's aim is to always stay a step ahead in innovation and the development of new products. NORMA's strengths as a solution provider are considerable.

To start with, the unrivaled breadth of its product range – itself the result of continual striving to develop new solutions for its customers' needs – puts the Group in a class of its own. Offering both plastic fluid systems and a vast range of metal clamps and couplings, NORMA can often propose different solutions for a single application. New product development benefits from extensive lifetime-testing and validation facilities that allow NORMA to carry out virtually all necessary tests in-house, analyzing any solution and application particularly effectively.

Foresight and anticipation

Developing the right products and ensuring they are ready for customers at the right time requires thinking ahead – often as much as five years – keeping abreast of legislation that will impact future technical specifications. In the automotive sector, for example, NORMA continually strives to enhance its complete solutions for exhaust after-treatment, help customers improve the efficiency of their engines and develop systems that perform optimally at higher mechanical and thermal stresses. Technical requirements in all NORMA's markets are becoming more challenging. The Group works closely with its customers' pre-development departments to discuss their plans and initiate and prioritize development projects related to future applications.

“By closely following worldwide statistics concerning market growth and future markets, we attempt to discern mega-trends and further anticipate tomorrow’s product requirements.”



A resourceful partner

Not merely responding to solution requests coming from the customer, NORMA is proactive in proposing new solutions that it has developed as a result of studying current and future market needs. The Group's business model is based on succeeding through creative technical leadership rather than being a “follower” in the market. NORMA will thus always strive to push further ahead in innovating for its customers.





Materials explanation

MATERIALS EXPLANATION	
W1	All parts entirely made from galvanized steel
W2	Band and housing: stainless steel AISI 430 Bolt: galvanized steel
W2B	Band: stainless steel AISI 430 Ti Screw and housing: galvanized steel
W3	All parts entirely made from stainless steel AISI 430
W4	All parts entirely made from stainless steel AISI 304
W5	All parts entirely made from stainless steel AISI 316





Materials International standard designations						
	DIN	AISI/AS	BS	AFNOR NF	SS	SUS
W1	Entirely galvanized steel					
Band and housing						
W2	1.4016	430	430 S 17	Z8 C17	2320	430
Bolt	Galvanized steel					
W3	1.4016	430	430 S 17	Z8 C17	2320	430
W4	1.4301	304	304 S 15	Z6 CN 18-09	2332	304
W5	1.4401	316	316 S 31	Z3 CND 17-11-1	2347	316
Spring insert	1.4310	301	301 S 22	Z12 CN 18-09	2331	301

Bolts

BOLTS	
Bolt type	Meaning
M	Bolt thread diameter in mm
Sk 	Hexagon-head bolt
Sz 	Slotted hexagon-head bolt
Zy 	Cylinder-head bolt

Pictogram explanation

NORMA® offers different tools, kits, assortments and displays to fit the needs of its customers. The drawings below will help you to know, in a quick glance, if the product is available in another packaging type or/and if it has a special tool.

PICTOGRAM	
Pictogram	Meaning
	A tool exists for this product, please refer to the Assortment chapter
	This product is available in a kit, please refer to the Assortment chapter
	This product is available in an assortment box please refer to the Assortment chapter
	This product is available in display please refer to the Assortment chapter

PRODUCT FAMILY	PRODUCT CATEGORY	PRODUCT NAME	PAGE
WORM DRIVE HOSE CLAMPS	PLAIN BAND	TORRO	20
		TORRO WF	24
		TORRO TORQUE CAP	25
		TORRO NOTCH	26
		TORRO THUMBSREW	27
		TORRO PREFIX SYSTEM	28
		TORRO WF PREFIX SYSTEM	29
		TORRO PREFIX CLIP	30
		TORRO TAMPERPROOF	31
		TORRO SAFETY CAP	32
		TORRO RADIAL INSERT	32
		TORRO SPIRO	33
		TORRO SAFETY COLLAR	33
		TORRO GAS CLAMP	34
		HD	35
	PERFORATED BAND	HI-TORQUE	36
	QUICK LOCK	QUICK LOCK 9 MM	37
		QUICK LOCK 12 MM	39
STRIP STEEL		40	
QUICK LOCK HOUSING		41	
HEAVY DUTY CLAMPS	TRUNNION CLAMPS	GBS HOLLOW TRUNNION	42
		GBS STC	44
		GBS QRC	45
		GBS MULTI PART	46
		GBS RUBBER INSERT	46
QUICK RELEASE	STANDARD	SVS	47
		SVS P	49
		SVS EYELET BOLT	50
RETAINING CLAMPS	METAL	S	51
		SP SINGLE	53
		SP DOUBLE	53
		SPGU	53
		HMK STANDARD DESIGN	54
		HMK SINGLE-PART HEAVY DUTY	56
		HMK TWO-PART HEAVY DUTY	56
HMK K1	56		
ONE PIECE CLAMPS	SCREWLESS CLAMP	COBRA	57
	SPRING BAND HOSE CLIPS	FBS STANDARD	59
		FBS R	61
		FBS C	61
		FBS HC	62
		FBS MC	63
EAR CLIPS	ONE EAR CLIPS	EARCLIP SINGLE	64
		EARCLIP SAFE	65
	TWO EAR CLIPS	EARCLIP DOUBLE	66

PLAIN BAND



PERFORATED BAND



QUICK LOCK



TRUNNION CLAMPS

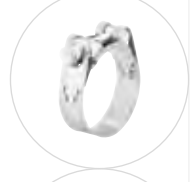

QUICK RELEASE



RETAINING CLAMPS



SCREWLESS CLAMP



SPRING BAND HOSE CLIPS



ONE EAR CLIPS



TWO EAR CLIPS

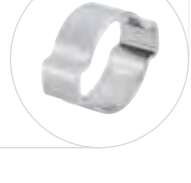

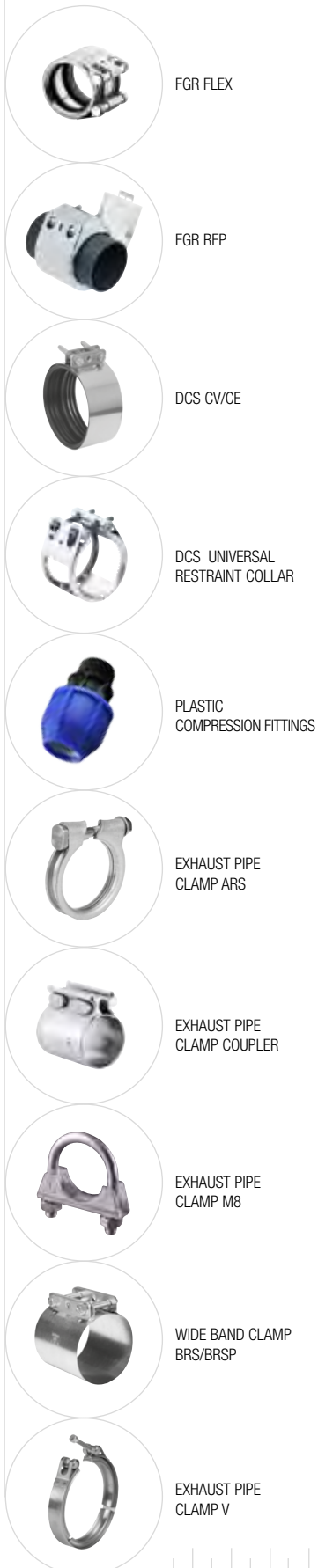

FGR FLEX

FGR RFP

DCS CV/CE

DCS UNIVERSAL RESTRAINT COLLAR

PLASTIC COMPRESSION FITTINGS

EXHAUST PIPE CLAMP ARS

EXHAUST PIPE CLAMP COUPLER

EXHAUST PIPE CLAMP M8

WIDE BAND CLAMP BRS/BRSP

EXHAUST PIPE CLAMP V

PRODUCT FAMILY	PRODUCT CATEGORY	PRODUCT NAME	PAGE
INFRASTRUCTURE CONNECTORS	FGR	FLEX	75
		FLEX E	78
		FLEX 3	80
		REP E	82
		GRIP	85
		GRIP E	88
		GRIP E-FP	90
		RFP	92
		PLAST GRIP	93
		PLAST GRIP E	94
		COMBI GRIP	95
		COMBI GRIP E	97
		SUPPORT SLEEVE	98
	DCS	RAPID	101
		RAPID MSM	102
		CV/CE	103
		SVE	104
		UNIVERSAL RESTRAINT COLLAR	105
		REKORD RESTRAINT COLLAR	106
		COMBI RESTRAINT COLLAR	107
FIX	108		
COMPRESSION FITTINGS	PLASTIC COMPRESSION FITTINGS	MALE THREADED ADAPTOR (MA)	111
		FEMALE THREADED ADAPTOR (FA)	111
		MALE THREADED TEE (MT)	112
		FEMALE THREADED TEE (FT)	112
		MALE THREADED ELBOW - MALE BEND 90 (MB)	113
		FEMALE THREADED ELBOW - FEMALE BEND 90 (FB)	113
		STRAIGHT COUPLER (SC)	114
		EQUAL BEND (EB)	114
		EQUAL TEE (ET)	114
		END CAP (EC)	115
		REDUCING COUPLER (RC)	115
		REDUCING TEE (RT)	116
		FLANGE ADAPTOR (FLA)	116
		POP-UP EQUAL BEND (PE)	116
		WALL PLATE ELBOW (WPE)	117
PIPE CLAMPS	EXHAUST PIPE CLAMP	MALE THREADED ADAPTOR WITH BRASS INSERT (MAB)	117
		FEMALE THREADED ADAPTOR WITH BRASS INSERT (FAB)	117
		FEMALE THREADED BEND WITH BRASS INSERT (FBB)	117
EXHAUST PIPE CLAMP		SEC	118
		ARS	119
		RS/DIN	121
		ACCUSEAL	123
		DURASEAL	125
		ACCULOCK	126
		COUPLER	127
		ACCUSEAL COUPLER	128
		PIPE CLAMP M8	129
		EASYSEAL	130
	WIDE BAND CLAMP	BRS / BRSP	131
		EXHAUST PIPE CLAMP	V STC
	V QRC		136
V SVS	136		

PRODUCT FAMILY	PRODUCT CATEGORY	PRODUCT NAME	PAGE
BANDING SYSTEMS	POLYAMIDE CABLE TIES	CABLE TIE WHITE	138
		CABLE TIE BLACK	138
		CABLE TIE COLORED	138
	PERFORATED BAND	PERFORATED BAND WAVE SHAPE	141
		PERFORATED BAND STRAIGHT SHAPE	141
		PERFORATED BAND MULTI HOLES	141
		PERFORATED BAND OVAL HOLES	141
	PLAIN BAND	NORMETTA® SMOOTH BAND	143
		NORMETTA® STAMPED BAND	143
		NORMETTA® PERFORATED BAND	143
	BUCKLES	NB-A	144
		NB-D	144
		NB-G	144
		NB-H	145
		NB-K	145
FIXING CLIPS AND STRAPS	RUBBER CLIPS	RSGU 1	146
		RSGU 0	148
		RSGU 2	149
	METAL CLIPS	RS 0	150
		RS 1	151
		RS 2	152
MOUNTING ELEMENTS	TUBE CLAMP FITTINGS	SLEEVE JOINT	154
		EXPANDING CONNECTOR	154
		90° ELBOW	154
		SHORT T	155
		LONG T	155
		WALL FLANGE	155
		RAILING BASE FLANGE	156
		HANDRAIL BRACKET	156
		3 WAYS 90° ELBOW	156
		CORNER C/W THROUGH TUBE	157
		TWO SOCKET CROSS	157
		SIDE OUTLET TEE	157
		FOUR WAY CROSS AND CENTER	158
		FIXING PAD	158
		DOUBLE WALL COUPLER	158
		MALE SWIVEL	159
		FEMALE SWIVEL	159
		GATE EYE	159
		GATE HINGE	159
		DOUBLE MALE SWIVEL	160
		90° CORNER MALE SWIVEL	160
		90° CROSSOVER	160
		SINGLE SWIVEL COMBINATION	161
		BASE SWIVEL COMBINATION	161
		DOUBLE SWIVEL COMBINATION	161
		90° CORNER SWIVEL COMBINATION	162
		SHORT TEE SWIVEL	162
	CLAMP ON TEE	162	
	FENCE BUILDING CLAMP	162	
	TRAFFIC SIGN FIXATION	ALU BAND CLAMP	163
UNIVERSAL UCC		164	

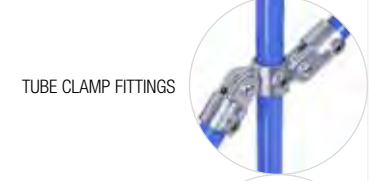
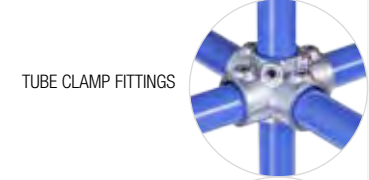
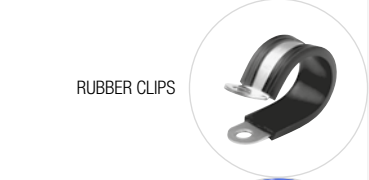
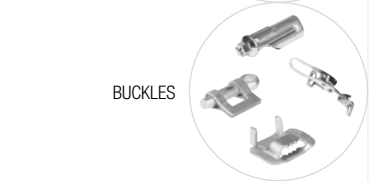



HOSE CONNECTORS TES
 HOSE CONNECTORS WES
 HOSE CONNECTORS GS
 HOSE CONNECTORS KS
 HOSE CONNECTORS YRS
 HOSE CONNECTORS YN
 HOSE CONNECTORS ET
 HOSE CONNECTORS EWS
 HOSE CONNECTORS EW/WW
 HOSE CONNECTORS VG/VGR



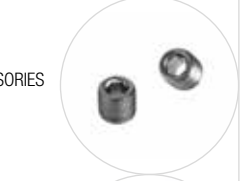
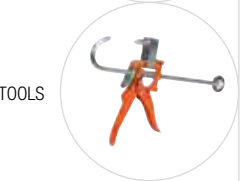
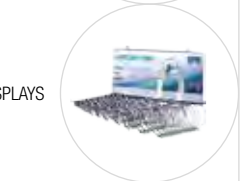
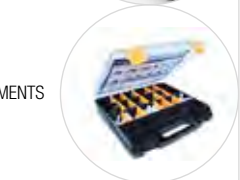

PRODUCT FAMILY	PRODUCT CATEGORY	PRODUCT NAME	PAGE
PLASTIC FITTINGS	HOSE CONNECTORS	GES	168
		BST	169
		TES	169
		WES	170
		GS	171
		GRS	171
		TS	171
		KS	172
		TRS	172
		YRS	172
		WS	173
		YS	173
		GN	173
		TN	174
		WN	174
		YN	174
		EG	175
		EWS	175
ETS	175		
ET	176		
EW / WW	176		
VT / VTR	177		
VG / VGR	177		

PRODUCT FAMILY	PRODUCT CATEGORY	PRODUCT NAME	PAGE
NORMA® KITS ASSORTMENTS DISPLAYS TOOLS ACCESSORIES	KITS	NORMAFIX® NORMETTA® Mini repair kits	180
		NORMACLAMP® Quick lock Band-on-roll	180
	ASSORTMENTS	NORMACLAMP® TORRO® Assortment type 120 pcs	181
		NORMACLAMP® TORRO® Assortment type 365 PA 6 and TORRO® W2	181
		NORMACLAMP® COBRA® kit type 500k	181
		NORMAFIX® RSGU 90 Pipe retaining clips assortment	182
		NORMAFIX® ASS-1N100 RSGU W1	182
		NORMAQUICK® PLAST Assortment	182
		DISPLAYS	NORMACLAMP® TORRO® Dispenser
	NORMACLAMP® TORRO® Drawer Box		183
	NORMACLAMP® TORRO® Pallet		183
	NORMACLAMP® TORRO® NHC 420 W1 Merchandiser		184
	NORMACLAMP® TORRO® NHC 420 W3 Merchandiser		184
	NORMACLAMP® TORRO® NHC 420 W4 Merchandiser		184
	NORMACLAMP® TORRO® NHC 135 W1 Merchandiser		185
	NORMACLAMP® TORRO® NHC 135 W3 Merchandiser		185
	NORMACLAMP® TORRO® NHC 135 W4 Merchandiser		185
	NORMACLAMP® TORRO® NHC 190 W1 Merchandiser		186
	NORMACLAMP® TORRO® NHC 190 W3 Merchandiser		186
	NORMACLAMP® TORRO® NHC 190 W4 Merchandiser		187
NORMACLAMP® GBS 75 Merchandiser	187		
NORMACLAMP® Quick lock Band-on-roll dispenser	187		
NORMA®- MOUNTING TOOLS	MOUNTING TOOLS	NORMACLAMP® TORRO® Assembly fixture	188
		NORMACLAMP® COBRA® Pneumatic pliers short version	188
		NORMACLAMP® COBRA® Pneumatic pliers long version	188
		NORMACLAMP® FBS Pneumatic pliers version S	188
		NORMACLAMP® FBS Pneumatic pliers version W	188
		NORMACLAMP® FBS C Multirelease tool	188
		NORMACONNECT® FGR Fitting pliers fitting belt for REP-E	189
		NORMAFIX® Cable tie pliers for 2.2 to 4.8 mm	189
		NORMAFIX® Cable tie pliers for 4.8 to 7.8 mm	189
		NORMAFIX® Cable tie pliers for 3.6 to 13 mm	189
		NORMAFIX® Cable tie pliers for 3.6 to 9 mm	189
		NORMAFIX® NORMETTA® Clamping and cutting tool	189
		NORMA®- PLIERS	PLIERS
NORMACLAMP® Earclip pliers for flat mounting	190		
NORMACLAMP® COBRA® Hand-held pliers CHT1	190		
NORMACLAMP® COBRA® Hand-held pliers CHT2	190		
NORMACLAMP® FBS Hand-held pliers Type 1	190		
NORMACLAMP® FBS Hand-held pliers Type 2	190		
NORMA®- SCREWDRIVERS	SCREWDRIVERS	NORMACLAMP® TORRO® Screwdriver SW6, SW7, SW6/7	191
		NORMACLAMP® Hi-torque T-screwdriver	191
		NORMAFIX® Tube clamp fittings Hexagonal key	191
NORMA®- ACCESSORIES	ACCESSORIES	NORMAFIX® Tube clamp fittings Aluminum End Cap	192
		NORMAFIX® Tube clamp fittings Plastic End Cap	192
		NORMAFIX® Tube clamp fittings Spare Screw	192
		NORMAFIX® Lamppost protection tape	192
		NORMAFIX® Cable tie Wall plug bases for cable tie	193
		NORMAFIX® Cable tie Mounting bases for cable tie	193



PRODUCT FAMILY	PRODUCT CATEGORY	PRODUCT NAME	PAGE
NORMA®- USER INFORMATION	INSTALLATION NOTICE	NORMACLAMP® Hi-torque	199
		NORMACONNECT® Compression fittings	199
		NORMAFIX® Cable tie	200
		NORMAPLAST® Hose connectors	200

INSTALLATION NOTICES

		Machine building	White goods	Chemical industry	Irrigation systems	Ship manufacturing
NORMACLAMP®		• • • • • • •	• • • • • •	• • • • • •	• • • • •	• • • •
NORMACONNECT®		• • • • • •		• • • • •	• • • • •	• • • • •
NORMAFIX®		• • • •	• • • •	• • • •	• • • •	• • • •
NORMAPLAST®		•	•	•	•	
NORMAEXTRA						
User Information						

Products and Applications

	Food and beverage industry	Railway industry	Agricultural machines	Building machines	Engine manufacturing	Pump and filter	Mining industry	Building and site drainage	
	• •	• • • • •	• • • • •	• • • • •	• • • • •	• • • • •	• • •	•	NORMACLAMP®
	• •	• •	• • • •	• • • •	• • • • •	• •	•	•	NORMACONNECT®
	• • •	• • • • •	• • • •	• • • • •	• • • • •	• • • • •	• • •	•	NORMAFIX®
	•	•	•	•	•	•			NORMAPLAST®
									NORMAEXTRA
									User Information

Products and Applications



Hose

NORMACLAMP® – Hose Clamps



Pipe / Spigot



Pipe

NORMACONNECT® – Pipe Connections



Pipe



Hose / Plastic* - /
Metal pipe

NORMAFIX® – Retaining Products



Wall / Ceiling /
Vehicle body



Hose

NORMAPLAST® – Hose Connectors**



Hose

* Can be designed into a complete system in conjunction with NORMAFLEX® smooth and/or corrugated tube.
** Several of the NORMACLAMP products can be used.

NORMACLAMP® – Hose Clamps

A reliable system thanks to optimized components

Whether you're looking for static hose clamps without springs or dynamic ones with springs, single-range or multi-range clamps, with NORMACLAMP® you'll find the perfect solution for any application.





- 1 Improved asymmetric housing**
– even distribution of forces and safe assembly
- 2 Screw support**
– ease of assembly due to the safe guidance of the emerging band end
- 3 Material and clamping range stamped on the band**
– prevention of errors
- 4 Asymmetric extension**
– prevents the housing from tilting over when the clamp is tightened
- 5 Short housing saddle**
– even contact pressure
– improved efficiency
- 6 Smooth or stamped inside of band**
– optimal hose protection

Worm drive hose clamps in accordance with DIN 3017

NORMACLAMP® TORRO® multi-range hose clamps are ideally suited to applications with high mechanical loads. Thanks to the continuous developments these products have undergone, they remain the benchmark within modern clamp construction. The key feature of a NORMACLAMP® TORRO® product is its asymmetrical construction - an instant sign that it is a genuine TORRO®.



Asymmetric housing provides high clamping force and superior torque strength. Even distribution of clamping pressure. Clamp aligns perfectly on the hose and ensures the optimal sealing of the connection.

Advantages at a glance

- Multi-range hose clamp
- No chromium(VI) used for coating purposes
- Clamping ranges in acc. with DIN 3017: 8-16 mm to 140-160 mm
- Larger diameters available on request

Applications

- Joining cooling water lines
- Depressurized and pressurized fuel lines and ventilation systems
- Oil lines
- Joining lines in sanitary applications
- Joining lines in machine building applications
- Lines in the household appliance industry
- Hose lines in the commercial vehicle industries

Materials

W1*	W2	W3	W4	W5
x	x	x	x	x

* No chromium(VI) used for the coating on the closure components

Material	Corrosion resistance in salt spray testing
W1	Min. 144 h
W2	Min. 72 h
W3	Min. 200 h*
W4	Min. 400 h
W5	Min. 1000 h

*Max 10% base metal corrosion permissible

Types of clamp band and screw

	W1	W2	W3	W4	W5
Phillips head SW 7*	•	•			
Slotted head SW 7			•	•	•

* Band width 7.5 mm = SW 6

Band width 7.5 mm

- W2, W3 with smooth inside

Band width 9 mm

- W1 with smooth inside
- W2, W3, W4, W5 with stamped inside

Band width 12 mm

- W1, W2, W3 with smooth inside
- W4, W5 with stamped inside

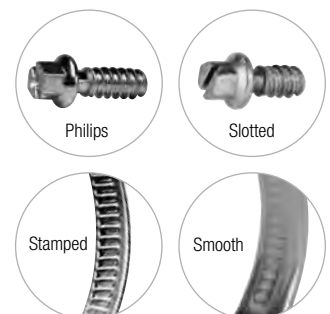

Table of torques

TORRO 7.5 W2-W3										
Diameter	8-12	10-16	12-18	12-22	16-27	20-32	25-40	30-45	35-50	40-60
TT	max 1.5	max 1.5	max 1.5	max 1.5	max 1.5					
FRT max										
TT	2	2	2	2	2					
BD min	2.25	2.25	2.25	2.25	2.25					

TORRO 9 W1										
Diameter	8-12	10-16	12-18	12-22	16-27	20-32	25-40	30-45	35-50	40-60
TT	2.5 +0.5	3 +0.5	3 +0.5	3 +0.5	3 +0.5	3 +0.5	3 +0.5	3 +0.5	3 +0.5	3 +0.5
FRT max	1.2	1.2	1.2	1.2	1.2	1.2	1.2	1.2	1.2	1.2
TT	3.3	4	4	4	4	4	4	4	4	4
BD min	4	4.5	4.5	4.5	4.5	4.5	6	6	6	6

TORRO 9 W2										
Diameter	50-70	60-80	70-90	80-100	90-110	100-120	110-130	120-140	130-150	140-160
TT	3 +0.5	3 +0.5	3 +0.5	3 +0.5	3 +0.5	3 +0.5	3 +0.5	3 +0.5	3 +0.5	3 +0.5
FRT max	1.2	1.2	1.2	1.2	1.2	1.2	1.2	1.2	1.2	1.2
TT	4	4	4	4	4	4	4	4	4	4
BD min	6	6	6	6	6	6	6	6	6	6

TORRO 9 W3										
Diameter	8-12	8-16	12-18	12-22	16-27	20-32	25-40	30-45	35-50	40-60
TT		2 +0.5		3 +0.5	3 +0.5	3 +0.5	3 +0.5	3 +0.5	3 +0.5	3 +0.5
FRT max		0.7		0.7	0.7	0.7	0.7	0.7	0.7	0.7
TT		2.6		4	4	4	4	4	4	4
BD min		4		4.5	4.5	4.5	4.5	4.5	4.5	4.5

TORRO 9 W4										
Diameter	50-70	60-80	70-90	80-100	90-110	100-120	110-130	120-140	130-150	140-160
TT	3 +0.5	3 +0.5	3 +0.5	3 +0.5	3 +0.5	3 +0.5	3 +0.5	3 +0.5	3 +0.5	3 +0.5
FRT max	0.7	0.7	0.7	0.7	0.7	0.7	0.7	0.7	0.7	0.7
TT	4	4	4	4	4	4	4	4	4	4
BD min	4.5	4.5	4.5	4.5	4.5	4.5	4.5	4.5	4.5	4.5

TORRO 9 W5										
Diameter	8-12	8-16	12-18	12-22	16-27	20-32	25-40	30-45	35-50	40-60
TT		2 +0.5		3 +0.5	3 +0.5	3 +0.5	3 +0.5	3 +0.5	3 +0.5	3 +0.5
FRT max		0.7		0.7	0.7	0.7	0.7	0.7	0.7	0.7
TT		2.6		4	4	4	4	4	4	4
BD min		4		4.5	4.5	4.5	4.5	4.5	4.5	4.5

TORRO 9 W6										
Diameter	50-70	60-80	70-90	80-100	90-110	100-120	110-130	120-140	130-150	140-160
TT	3 +0.5	3 +0.5	3 +0.5	3 +0.5	3 +0.5	3 +0.5	3 +0.5	3 +0.5	3 +0.5	3 +0.5
FRT max	0.7	0.7	0.7	0.7	0.7	0.7	0.7	0.7	0.7	0.7
TT	4	4	4	4	4	4	4	4	4	4
BD min	4.5	4.5	4.5	4.5	4.5	4.5	4.5	4.5	4.5	4.5

TT = Tightening Torque

FRT = Free Running Torque

TT = Testing Torque

BD = Break Torque

Table of torques

TORRO 12 W1

Diameter	8-12	10-16	12-18	12-22	16-27	20-32	25-40	30-45	35-50	40-60
TT					5 +0.5	5 +0.5	5 +0.5	5 +0.5	5 +0.5	5 +0.5
FRT max					1.2	1.2	1.2	1.2	1.2	1.2
TT					6.5	6.5	6.5	6.5	6.5	6.5
BD min					10	10	10	10	10	10

Diameter	50-70	60-80	70-90	80-100	90-110	100-120	110-130	120-140	130-150	140-160
TT	5 +0.5	5 +0.5	5 +0.5	5 +0.5	5 +0.5	5 +0.5	5 +0.5	5 +0.5	5 +0.5	5 +0.5
FRT max	1.2	1.2	1.2	1.2	1.2	1.2	1.2	1.2	1.2	1.2
TT	6.5	6.5	6.5	6.5	6.5	6.5	6.5	6.5	6.5	6.5
BD min	10	10	10	10	10	10	10	10	10	10

TORRO 12 W2/W3

Diameter	8-12	10-16	12-18	12-22	16-27	20-32	25-40	30-45	35-50	40-60
TT					5 +0.5	5 +0.5	5 +0.5	5 +0.5	5 +0.5	5 +0.5
LD max					1	1	1	1	1	1
TT					6.5	6.5	6.5	6.5	6.5	6.5
BD min					8.0	8.0	8.5	8.5	8.5	8.5

Diameter	50-70	60-80	70-90	80-100	90-110	100-120	110-130	120-140	130-150	140-160
TT	5 +0.5	5 +0.5	5 +0.5	5 +0.5	5 +0.5	5 +0.5	5 +0.5	5 +0.5	5 +0.5	5 +0.5
FRT max	1	1	1	1	1	1	1	1	1	1
TT	6.5	6.5	6.5	6.5	6.5	6.5	6.5	6.5	6.5	6.5
BD min	8.5	8.5	8.5	8.5	8.5	8.5	8.5	8.5	8.5	8.5

TORRO 12 W4/W5

Diameter	8-12	10-16	12-18	12-22	16-27	20-32	25-40	30-45	35-50	40-60
TT					5 +0.5	5 +0.5	5 +0.5	5 +0.5	5 +0.5	5 +0.5
FRT max					1	1	1	1	1	1
TT					6.5	6.5	6.5	6.5	6.5	6.5
BD min					8	8	8.5	8.5	8.5	8.5

Diameter	50-70	60-80	70-90	80-100	90-110	100-120	110-130	120-140	130-150	140-160
TT	5 +0.5	5 +0.5	5 +0.5	5 +0.5	5 +0.5	5 +0.5	5 +0.5	5 +0.5	5 +0.5	5 +0.5
FRT max	1	1	1	1	1	1	1	1	1	1
TT	6.5	6.5	6.5	6.5	6.5	6.5	6.5	6.5	6.5	6.5
BD min	8.5	8.5	8.5	8.5	8.5	8.5	8.5	8.5	8.5	8.5

TT = Tightening Torque

FRT = Free Running Torque

TT = Testing Torque

BD = Break Torque

WF



For this version of the NORMACLAMP® TORRO® the standard hose clamp is equipped with a spring insert on the inside of the clamp band. When tightening the screw the spring is loaded and stores sufficient clamping force to ensure a long-lasting automatic re-tensioning effect. Thus the radial clamping force achieved will be sufficient even under extremely low temperatures. Therefore, the TORRO® is an optimal solution for applications under extreme temperature changes (e.g., charged air) or for the retention of hoses with a tendency of 'creeping' (hose relaxation).

Advantages at a glance

- Automatic re-tensioning effect in the event of hose relaxation
- Increased sealing reliability across a wide temperature range

Materials

- W3, W4



NORMACLAMP® WF

Width	Designation	Clamping ranges		B	h	L	s	W3 Product No.	W4 Product No.
		in mm	in inches						
9	TORRO WF 8-16/9	8-16	5/16-5/8	13.0	11.0	21.0	0.65	0127 7708 013	0127 7711 013
	TORRO WF 12-18/9	12-18	1/2-11/16	13.0	11.0	24.0	0.65	0127 7708 018	0127 7711 015
	TORRO WF 12-20/9	12-20	1/2-13/16	13.0	11.0	24.0	0.65	0127 7708 016	0127 7711 016
	TORRO WF 12-22/9	12-22	1/2-7/8	13.0	11.0	24.0	0.65	0127 7708 017	0127 7711 017
	TORRO WF 16-25/9	16-25	5/8-1	13.0	11.0	24.0	0.65	0127 7708 020	0127 7711 020
	TORRO WF 16-27/9	16-27	5/8-1 1/16	13.0	11.0	24.0	0.65	0127 7708 021	0127 7711 021
	TORRO WF 20-32/9	20-32	13/16-1 1/4	13.0	11.0	24.0	0.65	0127 7708 026	0127 7711 026
	TORRO WF 23-35/9	23-35	15/16-1 3/8	13.0	11.0	24.0	0.65	0127 7708 029	0127 7711 029
	TORRO WF 25-40/9	25-40	1-1 9/16	13.0	11.0	26.0	0.65	0127 7708 032	0127 7711 032
	TORRO WF 30-45/9	30-45	1 3/16-1 3/4	13.0	11.0	26.0	0.65	0127 7708 037	0127 7711 037
	TORRO WF 32-50/9	32-50	1 3/8-2	13.0	11.0	26.0	0.65	0127 7708 041	0127 7711 041
	TORRO WF 40-60/9	40-60	1 9/16-2 3/8	13.0	11.0	26.0	0.65	0127 7708 050	0127 7711 050
	TORRO WF 45-65/9	45-65	1 3/4-2 9/16	13.0	11.0	26.0	0.65	0127 7708 055	0127 7711 055
	TORRO WF 50-70/9	50-70	2-2 3/4	13.0	11.0	26.0	0.65	0127 7708 060	0127 7711 060
	TORRO WF 60-80/9	60-80	2 3/8-3 1/8	13.0	11.0	26.0	0.65	0127 7708 070	0127 7711 070
	TORRO WF 70-90/9	70-90	2 3/4-3 9/16	13.0	11.0	26.0	0.65	0127 7708 080	0127 7711 080
	TORRO WF 80-100/9	80-100	3 1/8-3 15/16	13.0	11.0	26.0	0.65	0127 7708 090	0127 7711 090
TORRO WF 90-110/9	90-110	3 9/16-4 5/16	13.0	11.0	26.0	0.65	0127 7708 100	0127 7711 100	
TORRO WF 100-120/9	100-120	3 15/16-4 3/4	13.0	11.0	26.0	0.65	0127 7708 110	0127 7711 110	
TORRO WF 110-130/9	110-130	4 3/8-5 1/8	13.0	11.0	26.0	0.65	0127 7708 120	0127 7711 120	
12	TORRO WF 16-27/12	16-27	5/8-1 1/16	14.6	12.5	30.0	0.8	0137 7708 021	0137 7711 021
	TORRO WF 20-32/12	20-32	13/16-1 1/4	14.6	12.5	30.0	0.8	0137 7708 026	0137 7711 026
	TORRO WF 25-40/12	25-40	1-1 9/16	14.6	12.5	30.0	0.8	0137 7708 032	0137 7711 032
	TORRO WF 30-45/12	30-45	1 3/16-1 3/4	14.6	12.5	30.0	0.8	0137 7708 037	0137 7711 037
	TORRO WF 35-50/12	35-50	1 3/8-2	14.6	12.5	30.0	0.8	0137 7708 043	0137 7711 043
	TORRO WF 40-60/12	40-60	1 9/16-2 3/8	14.6	12.5	30.0	0.8	0137 7708 050	0137 7711 050
	TORRO WF 50-70/12	50-70	2-2 3/4	14.6	12.5	30.0	0.8	0137 7708 060	0137 7711 060
	TORRO WF 60-80/12	60-80	2 3/8-3 1/8	14.6	12.5	30.0	0.8	0137 7708 070	0137 7711 070
	TORRO WF 70-90/12	70-90	2 3/4-3 9/16	14.6	12.5	36.0	0.8	0137 7708 080	0137 7711 080
	TORRO WF 80-100/12	80-100	3 1/8-3 15/16	14.6	12.5	36.0	0.8	0137 7708 090	0137 7711 090
	TORRO WF 90-110/12	90-110	3 9/16-4 5/16	14.6	12.5	36.0	0.8	0137 7708 100	0137 7711 100



Refer to page 191.

Torque cap



The torque cap shares off when the permissible tightening torque is reached, thus saving the need to use a torque wrench. The bolt slot can still be accessed even after the break-off point, meaning that the clamp can be removed and/or re-tensioned if necessary.

Advantages at a glance

- Defined tightening torque without the need for special tools
- Installation can be checked visually

Materials

- W1, W2, W3, W4

NORMACLAMP® TORRO® WITH TORQUE CAP												
Width	Designation	Clamping ranges		B	h	L	s	S (W1 only)	W1 Product No.	W2 Product No.	W3 Product No.	W4 Product No.
		in mm	in inches									
9	TORRO TORQUE CAP 8-12/9	8-12	5/16-1/2	13.0	11.0	27.0	0.65	0.8	0126 7562 010	0126 7516 010	0126 7432 010	0126 7490 010
	TORRO TORQUE CAP 8-16/9 (10 - 16)	8-16	5/16-5/8	13.0	11.0	27.0	0.65	0.8	0126 7562 013	0126 7516 013	0126 7432 013	0126 7490 013
	TORRO TORQUE CAP 12-22/9	12-22	1/2-7/8	13.0	11.0	30.0	0.65	0.8	0126 7562 017	0126 7516 017	0126 7432 017	0126 7490 017
	TORRO TORQUE CAP 16-27/9	16-27	5/8-1 1/16	13.0	11.0	30.0	0.65	0.8	0126 7562 021	0126 7516 021	0126 7432 021	0126 7490 021
	TORRO TORQUE CAP 20-32/9	20-32	13/16-1 1/4	13.0	11.0	30.0	0.65	0.8	0126 7562 026	0126 7516 026	0126 7432 026	0126 7490 026
	TORRO TORQUE CAP 23-35/9	23-35	15/16-1 3/8	13.0	11.0	30.0	0.65	0.8	0126 7562 029	0126 7516 029	0126 7432 029	0126 7490 029
	TORRO TORQUE CAP 25-40/9	25-40	1-1 9/16	13.0	11.0	32.0	0.65	0.8	0126 7562 032	0126 7516 032	0126 7432 032	0126 7490 032
	TORRO TORQUE CAP 30-45/9	30-45	1 3/16-1 3/4	13.0	11.0	32.0	0.65	0.8	0126 7562 037	0126 7516 037	0126 7432 037	0126 7490 037
	TORRO TORQUE CAP 35-50/9 (32 - 50)	35-50	1 3/8-2	13.0	11.0	32.0	0.65	0.8	0126 7562 043	0126 7516 041	0126 7432 041	0126 7490 041
	TORRO TORQUE CAP 40-60/9	40-60	1 9/16-2 3/8	13.0	11.0	32.0	0.65	0.8	0126 7562 050	0126 7516 050	0126 7432 050	0126 7490 050
	TORRO TORQUE CAP 50-70/9	50-70	2-2 3/4	13.0	11.0	32.0	0.65	0.8	0126 7562 060	0126 7516 060	0126 7432 060	0126 7490 060
	TORRO TORQUE CAP 60-80/9	60-80	2 3/8-3 1/8	13.0	11.0	32.0	0.65	0.8	0126 7562 070	0126 7516 070	0126 7432 070	0126 7490 070
	TORRO TORQUE CAP 70-90/9	70-90	2 3/4-3 9/16	13.0	11.0	32.0	0.65	0.8	0126 7562 080	0126 7516 080	0126 7432 080	0126 7490 080
	TORRO TORQUE CAP 80-100/9	80-100	3 1/8-3 15/16	13.0	11.0	32.0	0.65	0.8	0126 7562 090	0126 7516 090	0126 7432 090	0126 7490 090
	TORRO TORQUE CAP 90-110/9	90-110	3 9/16-4 5/16	13.0	11.0	32.0	0.65	0.8	0126 7562 100	0126 7516 100	0126 7432 100	0126 7490 100
	TORRO TORQUE CAP 100-120/9	100-120	3 15/16-4 5/16	13.0	11.0	32.0	0.65	0.8	0126 6562 110	0126 6516 110	0126 6432 110	0126 6490 110
	TORRO TORQUE CAP 110-130/9	110-130	4 5/16-5 1/8	13.0	11.0	32.0	0.65	0.8	0126 6562 120	0126 6516 120	0126 6432 120	0126 6490 120
TORRO TORQUE CAP 120-140/9	120-140	4 3/4-5 1/2	13.0	11.0	32.0	0.65	0.8	0126 6562 130	0126 6516 130	0126 6432 130	0126 6490 130	
TORRO TORQUE CAP 130-150/9	130-150	5 1/8-5 15/16	13.0	11.0	32.0	0.65	0.8	0126 6562 140	0126 6516 140	0126 6432 140	0126 6490 140	
TORRO TORQUE CAP 140-160/9	140-160	5 1/2-6 5/16	13.0	11.0	32.0	0.65	0.8	0126 6562 150	0126 6516 150	0126 6432 150	0126 6490 150	
12	TORRO TORQUE CAP 16-27/12	16-27	5/8-1 1/16	14.6	12.5	36.0	0.8	0.8	0136 7135 021		0136 7181 021	
	TORRO TORQUE CAP 20-32/12	20-32	13/16-1 1/4	14.6	12.5	36.0	0.8	0.8	0136 7135 026		0136 7181 026	
	TORRO TORQUE CAP 23-35/12	23-35	15/16-1 3/8	14.6	12.5	36.0	0.8	0.8	0136 7135 029		0136 7181 029	
	TORRO TORQUE CAP 25-40/12	25-40	1-1 9/16	14.6	12.5	36.0	1.0	1.0	0136 7135 032		0136 7181 032	
	TORRO TORQUE CAP 30-45/12	30-45	1 3/16-1 3/4	14.6	12.5	36.0	1.0	1.0	0136 7135 037		0136 7181 037	
	TORRO TORQUE CAP 35-50/12	35-50	1 3/8-2	14.6	12.5	36.0	1.0	1.0	0136 7135 043		0136 7181 043	
	TORRO TORQUE CAP 40-60/12	40-60	1 9/16-2 3/8	14.6	12.5	36.0	1.0	1.0	0136 7135 050		0136 7181 050	
	TORRO TORQUE CAP 50-70/12	50-70	2-2 3/4	14.6	12.5	36.0	1.0	1.0	0136 7135 060		0136 7181 060	
	TORRO TORQUE CAP 60-80/12	60-80	2 3/8-3 1/8	14.6	12.5	36.0	1.0	1.0	0136 7135 070		0136 7181 070	
	TORRO TORQUE CAP 70-90/12	70-90	2 3/4-3 9/16	14.6	12.5	42.0	1.0	1.0	0136 7135 080		0136 7181 080	
	TORRO TORQUE CAP 80-100/12	80-100	3 1/8-3 15/16	14.6	12.5	42.0	1.0	1.0	0136 7135 090		0136 7181 090	
	TORRO TORQUE CAP 90-110/12	90-110	3 9/16-4 5/16	14.6	12.5	42.0	1.0	1.0	0136 7135 100		0136 7181 100	
	TORRO TORQUE CAP 100-120/12	100-120	3 15/16-4 3/4	14.6	12.5	42.0	1.0	1.0	0136 6135 110		0136 6181 110	
	TORRO TORQUE CAP 110-130/12	110-130	4 5/16-5 1/8	14.6	12.5	42.0	1.0	1.0	0136 6135 120		0136 6181 120	
	TORRO TORQUE CAP 120-140/12	120-140	4 3/4-5 1/2	14.6	12.5	42.0	1.0	1.0	0136 6135 130		0136 6181 130	
	TORRO TORQUE CAP 130-150/12	130-150	5 1/8-5 15/16	14.6	12.5	42.0	1.0	1.0	0136 6135 140		0136 6181 140	
	TORRO TORQUE CAP 140-160/12	140-160	5 1/2-6 5/16	14.6	12.5	42.0	1.0	1.0	0136 6135 150		0136 6181 150	

Notch



The notch is a clever means of prepositioning the TORRO® hose clip on the hose. In this case the oval hole in the clamp band finds its exact counterpart on the hose surface. Thus the TORRO® is safely and accurately kept in place prior to the final assembly.

Advantages at a glance

- Safe pre-assembly on rubber sleeves and molded pipes

Materials

- W3

NORMACLAMP® TORRO® NOTCH

Width	Designation	Clamping ranges		B	h	L	s	W3 Product No.
		in mm	in inches					
9	TORRO NOTCH 16-27/9	16-27	5/8-1 1/16	13.0	11.0	24.0	0.65	0126 6266 021
	TORRO NOTCH 20-32/9	20-32	13/16-1 1/4	13.0	11.0	24.0	0.65	0126 6266 026
	TORRO NOTCH 23-35/9	23-35	15/16-1 3/8	13.0	11.0	24.0	0.65	0126 6266 029
	TORRO NOTCH 25-40/9	25-40	1-1 9/16	13.0	11.0	26.0	0.65	0126 6266 032
	TORRO NOTCH 30-45/9	30-45	1 3/16-1 3/4	13.0	11.0	26.0	0.65	0126 6266 037
	TORRO NOTCH 32-50/9	32-50	1 1/4-2	13.0	11.0	26.0	0.65	0126 6266 041
	TORRO NOTCH 35-55/9	35-55	1 3/8-2 3/16	13.0	11.0	26.0	0.65	0126 6266 045
	TORRO NOTCH 40-60/9	40-60	1 5/8-2 3/8	13.0	11.0	26.0	0.65	0126 6266 050
	TORRO NOTCH 45-65/9	45-65	1 9/16-2 9/16	13.0	11.0	26.0	0.65	0126 6266 055
	TORRO NOTCH 50-70/9	50-70	2-2 3/4	13.0	11.0	26.0	0.65	0126 6266 060
	TORRO NOTCH 55-75/9	55-75	2 3/16-2 15/16	13.0	11.0	26.0	0.65	0126 6266 065
	TORRO NOTCH 60-80/9	60-80	2 3/8-3 1/8	13.0	11.0	26.0	0.65	0126 6266 070
	TORRO NOTCH 65-85/9	65-85	2 9/16-3 3/8	13.0	11.0	26.0	0.65	0126 6266 075
	TORRO NOTCH 70-90/9	70-90	2 3/4-3 9/16	13.0	11.0	26.0	0.65	0126 6266 080
	TORRO NOTCH 75-95/10	75-95	2 15/16-3 3/4	13.0	11.0	26.0	0.65	0126 6266 085
	TORRO NOTCH 80-100/9	80-100	3 1/8-3 15/16	13.0	11.0	26.0	0.65	0126 6266 090
	TORRO NOTCH 85-105/9	85-105	3 3/8-4 1/8	13.0	11.0	26.0	0.65	0126 6266 095
	TORRO NOTCH 90-110/9	90-110	3 1/2-4 3/8	13.0	11.0	26.0	0.65	0126 6266 100
TORRO NOTCH 100-120/9	100-120	3 9/16-4 3/4	13.0	11.0	26.0	0.65	0126 6266 110	
TORRO NOTCH 110-130/9	110-130	4 3/8-5 1/8	13.0	11.0	26.0	0.65	0126 6266 120	
TORRO NOTCH 120-140/9	120-140	4 3/4-5 1/2	13.0	11.0	26.0	0.65	0126 6266 130	
TORRO NOTCH 130-150/9	130-150	5 1/8-5 15/16	13.0	11.0	26.0	0.65	0126 6266 140	
TORRO NOTCH 140-160/9	140-160	5 1/2-6 5/16	13.0	11.0	26.0	0.65	0126 6266 150	
12	TORRO NOTCH 35-50/12	35-50	1 3/8-2	14.6	12.5	30.0	1.0	0136 6161 043
	TORRO NOTCH 40-55/12	40-55	1 9/16-2 3/16	14.6	12.5	30.0	1.0	0136 6161 048
	TORRO NOTCH 40-60/12	40-60	1 9/16-2 3/8	14.6	12.5	30.0	1.0	0136 6161 050
	TORRO NOTCH 45-65/12	45-65	1 3/4-2 9/16	14.6	12.5	30.0	1.0	0136 6161 055
	TORRO NOTCH 50-70/12	50-70	2-2 3/4	14.6	12.5	30.0	1.0	0136 6161 060
	TORRO NOTCH 60-80/12	60-80	2 3/8-3 1/8	14.6	12.5	30.0	1.0	0136 6161 070
	TORRO NOTCH 70-90/12	70-90	2 3/4-3 9/16	14.6	12.5	36.0	1.0	0136 6161 080
	TORRO NOTCH 80-100/12	80-100	3 1/8-3 15/16	14.6	12.5	36.0	1.0	0136 6161 090



Refer to page 191.

Prefix system



The NORMACLAMP® Prefix system is a concept for integrated clamps and clips on hoses and pipes. The demand for complete systems that include the appropriate sealing function is increasing. This system can only be fixed by using a special tool.

Advantages at a glance

- Safe pre-assembly on hoses and molded pipes
- Two versions, left- and right-handed

Materials

- W3, W4

NORMACLAMP® TORRO® PREFIX SYSTEM

Width	Designation	Clamping ranges		B	h	L	s	W3 Product No.		W4 Product No.	
		in mm	in inches					Right version	Left version	Right version	Left version
9	TORRO PREFIX SYSTEM 32-50/9	32-50	1 1/4-2	13.0	11.0	26.0	0.65	0126 6358 041	0126 6359 041	0126 6360 041	0126 6361 041
	TORRO PREFIX SYSTEM 35-55/9	35-50	1 3/8-2	13.0	11.0	26.0	0.65	0126 6358 045	0126 6359 045	0126 6360 045	0126 6361 045
	TORRO PREFIX SYSTEM 40-60/9	40-60	1 9/16-2 3/8	13.0	11.0	26.0	0.65	0126 6358 050	0126 6359 050	0126 6360 050	0126 6361 050
	TORRO PREFIX SYSTEM 45-65/9	45-65	1 3/4-2 9/16	13.0	11.0	26.0	0.65	0126 6358 055	0126 6359 055	0126 6360 055	0126 6361 055
	TORRO PREFIX SYSTEM 50-70/9	50-70	2-2 3/4	13.0	11.0	26.0	0.65	0126 6358 060	0126 6359 060	0126 6360 060	0126 6361 060
	TORRO PREFIX SYSTEM 55-75/9	55-75	2 3/16-2 15/16	13.0	11.0	26.0	0.65	0126 6358 065	0126 6359 065	0126 6360 065	0126 6361 065
	TORRO PREFIX SYSTEM 60-80/9	60-80	2 3/8-3 1/8	13.0	11.0	26.0	0.65	0126 6358 070	0126 6359 070	0126 6360 070	0126 6361 070
	TORRO PREFIX SYSTEM 65-85/9	65-85	2 9/16-3 3/8	13.0	11.0	26.0	0.65	0126 6358 075	0126 6359 075	0126 6360 075	0126 6361 075
	TORRO PREFIX SYSTEM 70-90/9	70-90	2 3/4-3 9/16	13.0	11.0	26.0	0.65	0126 6358 080	0126 6359 080	0126 6360 080	0126 6361 080
	TORRO PREFIX SYSTEM 75-95/9	75-95	2 15/16-3 3/4	13.0	11.0	26.0	0.65	0126 6358 085	0126 6359 085	0126 6360 085	0126 6361 085
TORRO PREFIX SYSTEM 80-100/9	80-100	3 1/8-3 15/16	13.0	11.0	26.0	0.65	0126 6358 090	0126 6359 090	0126 6360 090	0126 6361 090	
12	TORRO PREFIX SYSTEM 35-50/12	35-50	1 3/8-2	14.6	12.5	30.0	0.8	0136 6212 043	0136 6213 043	0136 6214 043	0136 6215 043
	TORRO PREFIX SYSTEM 40-55/12	40-55	1 9/16-2 3/16	14.6	12.5	30.0	0.8	0136 6212 048	0136 6213 048	0136 6214 048	0136 6215 048
	TORRO PREFIX SYSTEM 40-60/12	40-60	1 9/16-2 3/8	14.6	12.5	30.0	0.8	0136 6212 050	0136 6213 050	0136 6214 050	0136 6215 050
	TORRO PREFIX SYSTEM 45-65/12	45-65	1 3/4-2 9/16	14.6	12.5	30.0	0.8	0136 6212 055	0136 6213 055	0136 6214 055	0136 6215 055
	TORRO PREFIX SYSTEM 50-70/12	50-70	2-2 3/4	14.6	12.5	30.0	0.8	0136 6212 060	0136 6213 060	0136 6214 060	0136 6215 060
	TORRO PREFIX SYSTEM 55-75/12	55-75	2 3/16-2 15/16	14.6	12.5	30.0	0.8	0136 6212 065	0136 6213 065	0136 6214 065	0136 6215 065
	TORRO PREFIX SYSTEM 60-80/12	60-80	2 3/8-3 1/8	14.6	12.5	30.0	0.8	0136 6212 070	0136 6213 070	0136 6214 070	0136 6215 070
	TORRO PREFIX SYSTEM 65-85/12	65-85	2 9/16-3 3/8	14.6	12.5	30.0	0.8	0136 6212 075	0136 6213 075	0136 6214 075	0136 6215 075
	TORRO PREFIX SYSTEM 70-90/12	70-90	2 3/4-3 9/16	14.6	12.5	36.0	0.8	0136 6212 080	0136 6213 080	0136 6214 080	0136 6215 080
	TORRO PREFIX SYSTEM 75-95/12	75-95	2 15/16-3 3/4	14.6	12.5	36.0	0.8	0136 6212 085	0136 6213 085	0136 6214 085	0136 6215 085
	TORRO PREFIX SYSTEM 80-100/12	80-100	3 1/8-3 15/16	14.6	12.5	36.0	0.8	0136 6212 090	0136 6213 090	0136 6214 090	0136 6215 090
	TORRO PREFIX SYSTEM 90-110/12	90-110	3 9/16-4 5/16	14.6	12.5	36.0	0.8	0136 6212 100	0136 6213 100	0136 6214 100	0136 6215 100
TORRO PREFIX SYSTEM 100-120/12	100-120	3 15/16-4 3/4	14.6	12.5	36.0	0.8	0136 6212 110	0136 6213 110	0136 6214 110	0136 6215 110	



Refer to page 191.

WF Prefix system



The NORMACLAMP TORRO WF Prefix system is the combination of the NORMACLAMP TORRO WF and the NORMACLAMP Prefix system.

Advantages at a glance

- Axial adjustment of the clamp
- Radial adjustment of the clamp
- Angle adjustment
- Possible for multilayer hoses and blow molded pipes
- Already available in series for different hose thickness and TORRO 9/12
- Clinch design
- No corrosion issues
- Two versions, left- and right-handed
- No corrosion issues

Materials

- W3, W4

NORMACLAMP® TORRO® WF WITH PREFIX SYSTEM											
Width	Designation	Clamping ranges		B	h	L	s	W3 Product No.		W4 Product No.	
		in mm	in inches					Right version	Left version	Right version	Left version
9	TORRO WF PREFIX SYSTEM 32-50/9	32-50	1 1/4-2	13.0	11.0	26.0	0.65	0127 6254 041	0127 6255 041	0127 6256 041	0127 6257 041
	TORRO WF PREFIX SYSTEM 35-55/9	35-50	1 3/8-2	13.0	11.0	26.0	0.65	0127 6254 045	0127 6255 045	0127 6256 045	0127 6257 045
	TORRO WF PREFIX SYSTEM 40-60/9	40-60	1 9/16-2 3/8	13.0	11.0	26.0	0.65	0127 6254 050	0127 6255 050	0127 6256 050	0127 6257 050
	TORRO WF PREFIX SYSTEM 45-65/9	45-65	1 3/4-2 9/16	13.0	11.0	26.0	0.65	0127 6254 055	0127 6255 055	0127 6256 055	0127 6257 055
	TORRO WF PREFIX SYSTEM 50-70/9	50-70	2-2 3/4	13.0	11.0	26.0	0.65	0127 6254 060	0127 6255 060	0127 6256 060	0127 6257 060
	TORRO WF PREFIX SYSTEM 55-75/9	55-75	2 3/16-2 15/16	13.0	11.0	26.0	0.65	0127 6254 065	0127 6255 065	0127 6256 065	0127 6257 065
	TORRO WF PREFIX SYSTEM 60-80/9	60-80	2 3/8-3 1/8	13.0	11.0	26.0	0.65	0127 6254 070	0127 6255 070	0127 6256 070	0127 6257 070
	TORRO WF PREFIX SYSTEM 65-85/9	65-85	2 9/16-3 3/8	13.0	11.0	26.0	0.65	0127 6254 075	0127 6255 075	0127 6256 075	0127 6257 075
	TORRO WF PREFIX SYSTEM 70-90/9	70-90	2 3/4-3 9/16	13.0	11.0	26.0	0.65	0127 6254 080	0127 6255 080	0127 6256 080	0127 6257 080
	TORRO WF PREFIX SYSTEM 75-95/9	75-95	2 15/16-3 3/4	13.0	11.0	26.0	0.65	0127 6254 085	0127 6255 085	0127 6256 085	0127 6257 085
TORRO WF PREFIX SYSTEM 80-100/9	80-100	3 1/8-3 15/16	13.0	11.0	26.0	0.65	0127 6254 090	0127 6255 090	0127 6256 090	0127 6257 090	
12	TORRO WF PREFIX SYSTEM 35-50/12	35-50	1 3/8-2	14.6	12.5	30.0	0.8	0137 6212 043	0137 6213 043	0137 6214 043	0137 6215 043
	TORRO WF PREFIX SYSTEM 40-55/12	40-55	1 9/16-2 3/16	14.6	12.5	30.0	0.8	0137 6212 048	0137 6213 048	0137 6214 048	0137 6215 048
	TORRO WF PREFIX SYSTEM 40-60/12	40-60	1 9/16-2 3/8	14.6	12.5	30.0	0.8	0137 6212 050	0137 6213 050	0137 6214 050	0137 6215 050
	TORRO WF PREFIX SYSTEM 45-65/12	45-65	1 3/4-2 9/16	14.6	12.5	30.0	0.8	0137 6212 055	0137 6213 055	0137 6214 055	0137 6215 055
	TORRO WF PREFIX SYSTEM 50-70/12	50-70	2-2 3/4	14.6	12.5	30.0	0.8	0137 6212 060	0137 6213 060	0137 6214 060	0137 6215 060
	TORRO WF PREFIX SYSTEM 55-75/12	55-75	2 3/16-2 15/16	14.6	12.5	30.0	0.8	0137 6212 065	0137 6213 065	0137 6214 065	0137 6215 065
	TORRO WF PREFIX SYSTEM 60-80/12	60-80	2 3/8-3 1/8	14.6	12.5	30.0	0.8	0137 6212 070	0137 6213 070	0137 6214 070	0137 6215 070
	TORRO WF PREFIX SYSTEM 65-85/12	65-85	2 9/16-3 3/8	14.6	12.5	30.0	0.8	0137 6212 075	0137 6213 075	0137 6214 075	0137 6215 075
	TORRO WF PREFIX SYSTEM 70-90/12	70-90	2 3/4-3 9/16	14.6	12.5	36.0	0.8	0137 6212 080	0137 6213 080	0137 6214 080	0137 6215 080
	TORRO WF PREFIX SYSTEM 75-95/12	75-95	2 15/16-3 3/4	14.6	12.5	36.0	0.8	0137 6212 085	0137 6213 085	0137 6214 085	0137 6215 085
	TORRO WF PREFIX SYSTEM 80-100/12	80-100	3 1/8-3 15/16	14.6	12.5	36.0	0.8	0137 6212 090	0137 6213 090	0137 6214 090	0137 6215 090
	TORRO WF PREFIX SYSTEM 90-110/12	90-110	3 9/16-4 3/8	14.6	12.5	36.0	0.8	0137 6212 100	0137 6213 100	0137 6214 100	0137 6215 100
	TORRO WF PREFIX SYSTEM 100-120/12	100-120	3 9/16-4 3/4	14.6	12.5	36.0	0.8	0137 6212 110	0137 6213 110	0137 6214 110	0137 6215 110



Refer to page 191.

Prefix clip



With this accessory the TORRO® can also be prepositioned on the hose. The two ‘teeth’ of this device keep the TORRO® hose clip safely in place if it needs to be stocked or transported prior to its final assembly.

Advantages at a glance

- Safe pre-assembly on the hose
- Two versions, left- and right-handed

Materials

- W3, W4

NORMACLAMP® TORRO® PREFIX CLIP

Width	Designation	Clamping ranges		B	h	L	s	W3 Product No.		W4 Product No.	
		in mm	in inches					Right version	Left version	Right version	Left version
9	TORRO PREFIX CLIP 16-27/9	16-27	5/8-1 1/16	13.0	11.0	24.0	0.65	0126 6318 021	0126 6319 021		
	TORRO PREFIX CLIP 20-32/9	20-32	13/16-1 1/4	13.0	11.0	24.0	0.65	0126 6318 026	0126 6319 026		
	TORRO PREFIX CLIP 23-35/9	23-35	15/16-1 3/8	13.0	11.0	24.0	0.65	0126 6318 029	0126 6319 029		
	TORRO PREFIX CLIP 25-40/9	25-40	1-1 9/16	13.0	11.0	26.0	0.65	0126 6318 032	0126 6319 032		
	TORRO PREFIX CLIP 30-45/9	30-45	1 3/16-1 3/4	13.0	11.0	26.0	0.65	0126 6318 037	0126 6319 037		
	TORRO PREFIX CLIP 32-50/9	32-50	1 1/4-2	13.0	11.0	26.0	0.65	0126 6318 041	0126 6319 041		
	TORRO PREFIX CLIP 35-55/9	35-50	1 3/8-2	13.0	11.0	26.0	0.65	0126 6318 045	0126 6319 045		
	TORRO PREFIX CLIP 40-60/9	40-60	1 9/16-2 3/8	13.0	11.0	26.0	0.65	0126 6318 050	0126 6319 050		
	TORRO PREFIX CLIP 45-65/9	45-65	1 3/4-2 9/16	13.0	11.0	26.0	0.65	0126 6318 055	0126 6319 055		
	TORRO PREFIX CLIP 50-70/9	50-70	2-2 3/4	13.0	11.0	26.0	0.65	0126 6318 060	0126 6319 060		
	TORRO PREFIX CLIP 55-75/9	55-75	2 3/16-2 15/16	13.0	11.0	26.0	0.65	0126 6318 065	0126 6319 065		
	TORRO PREFIX CLIP 60-80/9	60-80	2 3/8-3 1/8	13.0	11.0	26.0	0.65	0126 6318 070	0126 6319 070		
	TORRO PREFIX CLIP 65-85/9	65-85	2 9/16-3 3/8	13.0	11.0	26.0	0.65	0126 6318 075	0126 6319 075		
	TORRO PREFIX CLIP 70-90/9	70-90	2 3/4-3 9/16	13.0	11.0	26.0	0.65	0126 6318 080	0126 6319 080		
TORRO PREFIX CLIP 75-95/9	75-95	2 15/16-3 3/4	13.0	11.0	26.0	0.65	0126 6318 085	0126 6319 085			
TORRO PREFIX CLIP 80-100/9	80-100	3 1/8-3 15/16	13.0	11.0	26.0	0.65	0126 6318 090	0126 6319 090			
12	TORRO PREFIX CLIP 16-27/12	16-27	5/8-1 1/16	14.6	12.5	30.0	0.8	0136 6210 021	0136 6211 021		
	TORRO PREFIX CLIP 20-32/12	20-32	13/16-1 1/4	14.6	12.5	30.0	0.8	0136 6210 026	0136 6211 026		
	TORRO PREFIX CLIP 23-35/12	23-35	15/16-1 3/8	14.6	12.5	30.0	0.8	0136 6210 029	0136 6211 029		
	TORRO PREFIX CLIP 25-40/12	25-40	1-1 9/16	14.6	12.5	30.0	0.8	0136 6210 032	0136 6211 032		
	TORRO PREFIX CLIP 30-45/12	30-45	1 3/16-1 3/4	14.6	12.5	30.0	0.8	0136 6210 037	0136 6211 037		
	TORRO PREFIX CLIP 35-50/12	32-50	1 1/4-2	14.6	12.5	30.0	0.8	0136 6210 043	0136 6211 043	0136 0322 043	0136 0323 043
	TORRO PREFIX CLIP 40-55/12	35-55	1 3/8-2 3/16	14.6	12.5	30.0	0.8	0136 6210 048	0136 6211 048	0136 0322 048	0136 0323 048
	TORRO PREFIX CLIP 40-60/12	40-60	1 9/16-2 3/8	14.6	12.5	30.0	0.8	0136 6210 050	0136 6211 050	0136 0322 050	0136 0323 050
	TORRO PREFIX CLIP 45-65/12	45-65	1 3/4-2 9/16	14.6	12.5	30.0	0.8	0136 6210 055	0136 6211 055	0136 0322 055	0136 0323 055
	TORRO PREFIX CLIP 50-70/12	50-70	2-2 3/4	14.6	12.5	30.0	0.8	0136 6210 060	0136 6211 060	0136 0322 060	0136 0323 060
	TORRO PREFIX CLIP 55-75/12	55-75	2 3/16-2 15/16	14.6	12.5	30.0	0.8	0136 6210 065	0136 6211 065	0136 0322 065	0136 0323 065
	TORRO PREFIX CLIP 60-80/12	60-80	2 3/8-3 1/8	14.6	12.5	30.0	0.8	0136 6210 070	0136 6211 070	0136 0322 070	0136 0323 070
	TORRO PREFIX CLIP 65-85/12	65-85	2 9/16-3 3/8	14.6	12.5	30.0	0.8	0136 6210 075	0136 6211 075	0136 0322 075	0136 0323 075
	TORRO PREFIX CLIP 70-90/12	70-90	2 3/4-3 9/16	14.6	12.5	36.0	0.8	0136 6210 080	0136 6211 080	0136 0322 080	0136 0323 080
TORRO PREFIX CLIP 75-95/12	75-95	2 15/16-3 3/4	14.6	12.5	36.0	0.8	0136 6210 085	0136 6211 085	0136 0322 085	0136 0323 085	
TORRO PREFIX CLIP 80-100/12	80-100	3 1/8-3 15/16	14.6	12.5	36.0	0.8	0136 6210 090	0136 6211 090	0136 0322 090	0136 0323 090	



Refer to page 191.

Tamperproof



The NORMACLAMP® TORRO® Tamperproof can only be mounted and dismantled by using a special tool. The specially designed screw head has three radial grooves, which means it cannot be adjusted with any commercially available tools. Automated assembly using a torque gun is particularly effective, as the special shape of the screw head allows for minimal misalignment or offset.

Advantages at a glance

- Non-dismountable clamps protects against manipulation

Materials

- W3, W4

NORMACLAMP® TORRO® TAMPERPROOF									
Width	Designation	Clamping ranges		B	h	L	s	W3 Product No.	W4 Product No.
		mm	inches						
9	TORRO TAMPERPROOF 8-12/9	8-12	5/16-1/2	13.0	11.0	21.0	0.65	0126 6468 010	0126 6469 010
	TORRO TAMPERPROOF 8-16/9	8-16	5/16-5/8	13.0	11.0	21.0	0.65	0126 6468 013	0126 6469 013
	TORRO TAMPERPROOF 12-20/9	12-20	1/2-13/16	13.0	11.0	24.0	0.65	0126 6468 016	0126 6469 016
	TORRO TAMPERPROOF 12-22/9	12-22	1/2-7/8	13.0	11.0	24.0	0.65	0126 6468 017	0126 6469 017
	TORRO TAMPERPROOF 16-25/9	16-25	5/8-1	13.0	11.0	24.0	0.65	0126 6468 020	0126 6469 020
	TORRO TAMPERPROOF 16-27/9	16-27	5/8-1 1/16	13.0	11.0	24.0	0.65	0126 6468 021	0126 6469 021
	TORRO TAMPERPROOF 20-32/9	20-32	13/16-1 1/4	13.0	11.0	24.0	0.65	0126 6468 026	0126 6469 026
	TORRO TAMPERPROOF 23-35/9	23-35	15/16-1 3/8	13.0	11.0	24.0	0.65	0126 6468 029	0126 6469 029
	TORRO TAMPERPROOF 25-40/9	25-40	1-1 9/16	13.0	11.0	26.0	0.65	0126 6468 032	0126 6469 032
	TORRO TAMPERPROOF 30-45/9	30-45	1 3/16-1 3/4	13.0	11.0	26.0	0.65	0126 6468 037	0126 6469 037
	TORRO TAMPERPROOF 32-50/9	32-50	1 1/4-2	13.0	11.0	26.0	0.65	0126 6468 041	0126 6469 041
	TORRO TAMPERPROOF 35-55/9	35-55	1 3/8-2 3/16	13.0	11.0	26.0	0.65	0126 6468 045	0126 6469 045
	TORRO TAMPERPROOF 40-60/9	40-60	1 9/16-2 3/8	13.0	11.0	26.0	0.65	0126 6468 050	0126 6469 050
	TORRO TAMPERPROOF 45-65/9	45-65	1 3/4-2 9/16	13.0	11.0	26.0	0.65	0126 6468 055	0126 6469 055
	TORRO TAMPERPROOF 50-70/9	50-70	2-2 3/4	13.0	11.0	26.0	0.65	0126 6468 060	0126 6469 060
	TORRO TAMPERPROOF 55-75/9	55-75	2 3/16-2 15/16	13.0	11.0	26.0	0.65	0126 6468 065	0126 6469 065
	TORRO TAMPERPROOF 60-80/9	60-80	2 3/8-3 1/8	13.0	11.0	26.0	0.65	0126 6468 070	0126 6469 070
	TORRO TAMPERPROOF 65-85/9	65-85	2 9/16-3 3/8	13.0	11.0	26.0	0.65	0126 6468 075	0126 6469 075
	TORRO TAMPER PROOF 70-90/9	70-90	2 3/4-3 9/16	13.0	11.0	26.0	0.65	0126 6468 080	0126 6469 080
	TORRO TAMPERPROOF 75-95/9	75-95	2 15/16-3 3/4	13.0	11.0	26.0	0.65	0126 6468 085	0126 6469 085
TORRO TAMPERPROOF 80-100/9	80-100	3 1/8-3 15/16	13.0	11.0	26.0	0.65	0126 6468 090	0126 6469 090	
TORRO TAMPERPROOF 90-110/9	90-110	3 9/16-4 5/16	13.0	11.0	26.0	0.65	0126 6468 100	0126 6469 100	
TORRO TAMPERPROOF 100-120/9	100-120	3 15/16-4 3/4	13.0	11.0	26.0	0.65	0126 6468 110	0126 6469 110	
TORRO TAMPERPROOF 110-130/9	110-130	4 5/16-5 1/8	13.0	11.0	26.0	0.65	0126 6468 120	0126 6469 120	
TORRO TAMPERPROOF 120-140/9	120-140	4 3/4-5 1/2	13.0	11.0	26.0	0.65	0126 6468 130	0126 6469 130	
TORRO TAMPERPROOF 130-150/9	130-150	5 1/8-5 15/16	13.0	11.0	26.0	0.65	0126 6468 140	0126 6469 140	
TORRO TAMPERPROOF 140-160/9	140-160	5 1/2-6 5/16	13.0	11.0	26.0	0.65	0126 6468 150	0126 6469 150	
12	TORRO TAMPERPROOF 16-27/12	16-27	5/8-1 1/16	14.6	12.5	30.0	0.8	0136 6358 021	0136 6359 021
	TORRO TAMPERPROOF 20-32/12	20-32	13/16-1 1/4	14.6	12.5	30.0	0.8	0136 6358 026	0136 6359 026
	TORRO TAMPERPROOF 23-35/12	23-35	15/16-1 3/8	14.6	12.5	30.0	0.8	0136 6358 029	0136 6359 029
	TORRO TAMPERPROOF 25-40/12	25-40	1-1 9/16	14.6	12.5	30.0	0.8	0136 6358 032	0136 6359 032
	TORRO TAMPERPROOF 30-45/12	30-45	1 3/16-1 3/4	14.6	12.5	30.0	0.8	0136 6358 037	0136 6359 037
	TORRO TAMPERPROOF 35-50/12	35-50	1 3/8-2	14.6	12.5	30.0	0.8	0136 6358 043	0136 6359 043
	TORRO TAMPERPROOF 40-55/12	40-55	1 9/16-2 3/16	14.6	12.5	30.0	0.8	0136 6358 048	0136 6359 048
	TORRO TAMPERPROOF 40-60/12	40-60	1 9/16-2 3/8	14.6	12.5	30.0	0.8	0136 6358 050	0136 6359 050
	TORRO TAMPERPROOF 45-65/12	45-65	1 3/4-2 9/16	14.6	12.5	30.0	0.8	0136 6358 055	0136 6359 055
	TORRO TAMPERPROOF 50-70/12	50-70	2-2 3/4	14.6	12.5	30.0	0.8	0136 6358 060	0136 6359 060
	TORRO TAMPERPROOF 55-75/12	55-75	2 3/16-2 15/16	14.6	12.5	30.0	0.8	0136 6358 065	0136 6359 065
	TORRO TAMPERPROOF 60-80/12	60-80	2 3/8-3 1/8	14.6	12.5	30.0	0.8	0136 6358 070	0136 6359 070
	TORRO TAMPERPROOF 65-85/12	65-85	2 9/16-3 3/8	14.6	12.5	30.0	0.8	0136 6358 075	0136 6359 075
	TORRO TAMPERPROOF 70-90/12	70-90	2 3/4-3 9/16	14.6	12.5	36.0	0.8	0136 6358 080	0136 6359 080
	TORRO TAMPERPROOF 75-95/12	75-95	2 15/16-3 3/4	14.6	12.5	36.0	0.8	0136 6358 085	0136 6359 085
	TORRO TAMPERPROOF 80-100/12	80-100	3 1/8-3 15/16	14.6	12.5	36.0	0.8	0136 6358 090	0136 6359 090
	TORRO TAMPERPROOF 90-110/12	90-110	3 9/16-4 5/16	14.6	12.5	36.0	0.8	0136 6358 100	0136 6359 100
	TORRO TAMPERPROOF 100-120/12	100-120	3 15/16-4 3/4	14.6	12.5	36.0	0.8	0136 6358 110	0136 6359 110
	TORRO TAMPERPROOF 110-130/12	110-130	4 5/16-5 1/8	14.6	12.5	36.0	0.8	0136 6358 120	0136 6359 120
	TORRO TAMPERPROOF 120-140/12	120-140	4 3/4-5 1/2	14.6	12.5	36.0	0.8	0136 6358 130	0136 6359 130
TORRO TAMPERPROOF 130-150/12	130-150	5 1/8-5 15/16	14.6	12.5	36.0	0.8	0136 6358 140	0136 6359 140	
TORRO TAMPERPROOF 140-160/12	140-160	5 1/2-6 5/16	14.6	12.5	36.0	0.8	0136 6358 150	0136 6359 150	

Safety cap



The NORMACLAMP® TORRO® safety cap is a small plastic cap which covers the end of the clamp band, thus stopping injuries from occurring and making a significant contribution to accident prevention measures.

Advantages at a glance

- Available for band widths 7.5 mm, 9 mm and 12 mm

Materials

- Plastic

NORMACLAMP® TORRO® SAFETY CAP

Width	Designation	For all Materials Product No.
7.5	THE SAFETY CAP 7.5	0045 8000 021
9	THE SAFETY CAP 9	0045 8000 022
12	THE SAFETY CAP 12	0045 8000 023

Radial insert



The Radial® Spring Clamp consists of a Standard riveted clamp with a stainless steel liner. This insert in the Radial acts as a spring. Inward radial pressure on the hose is made possible as the material between the cut-outs and the longitudinal beads acts as leaf springs.

Advantages at a glance

- Radial integrated element located on the inside of the clamp band
- High contact pressure due to the radially corrugated design
- There are also dynamic properties

Materials

- W1

NORMACLAMP® TORRO® RADIAL INSERT

Width	Designation	Clamping ranges		B	h	L	s	W1 Product No.
		in mm	in inches					
9	TORRO RADIAL INSERT 16-25/9	16-25	5/8-1	13.0	11.0	24.0	0.8	0127 6262 020
	TORRO RADIAL INSERT 16-27/9	16-27	5/8-1 1/16	13.0	11.0	24.0	0.8	0127 6262 021
	TORRO RADIAL INSERT 20-32/9	20-32	13/16-1 1/4	13.0	11.0	24.0	0.8	0127 6262 026
	TORRO RADIAL INSERT 23-35/9	23-35	1-1 3/8	13.0	11.0	24.0	0.8	0127 6262 029
	TORRO RADIAL INSERT 25-40/9	25-40	1-1 9/16	13.0	11.0	26.0	0.8	0127 6262 032
	TORRO RADIAL INSERT 30-45/9	30-45	1 3/16-1 3/4	13.0	11.0	26.0	0.8	0127 6262 037
	TORRO RADIAL INSERT 35-50/9	32-50	1 1/4-2	13.0	11.0	26.0	0.8	0127 6262 043
	TORRO RADIAL INSERT 35-55/9	35-50	1 3/8-2	13.0	11.0	26.0	0.8	0127 6262 045
	TORRO RADIAL INSERT 40-60/9	40-60	1 9/16-2 3/8	13.0	11.0	26.0	0.8	0127 6262 050
	TORRO RADIAL INSERT 45-65/9	45-65	1 3/4-2 9/16	13.0	11.0	26.0	0.8	0127 6262 055
	TORRO RADIAL INSERT 50-70/9	50-70	2-2 3/4	13.0	11.0	26.0	0.8	0127 6262 060
	TORRO RADIAL INSERT 55-75/9	55-75	2 3/16-2 15/16	13.0	11.0	26.0	0.8	0127 6262 065
	TORRO RADIAL INSERT 60-80/9	60-80	2 3/8-3 1/8	13.0	11.0	26.0	0.8	0127 6262 070
	TORRO RADIAL INSERT 65-85/9	65-85	2 9/16-3 3/8	13.0	11.0	26.0	0.8	0127 6262 075
	TORRO RADIAL INSERT 70-90/9	70-90	2 3/4-3 9/16	13.0	11.0	26.0	0.8	0127 6262 080
	TORRO RADIAL INSERT 75-95/9	75-95	2 15/16-3 3/4	13.0	11.0	26.0	0.8	0127 6262 085
TORRO RADIAL INSERT 80-100/9	80-100	3 1/8-3 15/16	13.0	11.0	26.0	0.8	0127 6262 090	
TORRO RADIAL INSERT 90-110/9	90-110	3 9/16-4 5/16	13.0	11.0	26.0	0.8	0127 6262 100	



Refer to page 191.

Spiro



The NORMACLAMP® TORRO® Spiro is the ideal clamp for industrial spiral hoses made of plastic material.

Advantages at a glance

- Band divided in two parts linked with a bridge for asymmetrical connection
- Two versions, left- and right-handed

Materials

- W1, W2 , W4

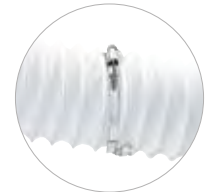

NORMACLAMP® TORRO® SPIRO									
Width	Designation	Clamping ranges		W1 Product No.		W2 Product No.		W4 Product No.	
		in mm	in inches	Right version	Left version	Right version	Left version	Right version	Left version
9	TORRO SPIRO 40-60/9	40-60	1 9/16-2 3/8	0126 7644 050	0126 7645 050	0126 7646 050	0126 7647 050	0126 7648 050	0126 7649 050
	TORRO SPIRO 50-70/9	50-70	2-2 3/4	0126 7644 060	0126 7645 060	0126 7646 060	0126 7647 060	0126 7648 060	0126 7649 060
	TORRO SPIRO 60-80/9	60-80	2 3/8-3 1/8	0126 7644 070	0126 7645 070	0126 7646 070	0126 7647 070	0126 7648 070	0126 7649 070
	TORRO SPIRO 70-90/9	70-90	2 3/4-3 9/16	0126 7644 080	0126 7645 080	0126 7646 080	0126 7647 080	0126 7648 080	0126 7649 080
	TORRO SPIRO 80-100/9	80-100	3 1/8-3 15/16	0126 7644 090	0126 7645 090	0126 7646 090	0126 7647 090	0126 7648 090	0126 7649 090
	TORRO SPIRO 90-110/9	90-110	3 9/16-4 5/16	0126 7644 100	0126 7645 100	0126 7646 100	0126 7647 100	0126 7648 100	0126 7649 100
	TORRO SPIRO 100-120/9	100-120	3 15/16-4 3/4	0126 7644 110	0126 7645 110				
	TORRO SPIRO 110-130/9	110-130	4 5/16-5 1/8	0126 7644 120	0126 7645 120				
	TORRO SPIRO 120-140/9	120-140	4 3/4-5 1/2	0126 7644 130	0126 7645 130				
	TORRO SPIRO 130-150/9	130-150	5 1/8-5 15/16	0126 7644 140	0126 7645 140				
TORRO SPIRO 140-160/9	140-160	5 1/2-6 5/16	0126 7644 150	0126 7645 150					
12	TORRO SPIRO 40-60/12	40-60	1 9/16-2 3/8	0136 7662 050	0136 7663 050	0136 7664 050	0136 7665 050	0136 7666 050	0136 7667 050
	TORRO SPIRO 50-70/12	50-70	2-2 3/4	0136 7662 060	0136 7663 060	0136 7664 060	0136 7665 060	0136 7666 060	0136 7667 060
	TORRO SPIRO 60-80/12	60-80	2 3/8-3 1/8	0136 7662 070	0136 7663 070	0136 7664 070	0136 7665 070	0136 7666 070	0136 7667 070
	TORRO SPIRO 70-90/12	70-90	2 3/4-3 9/16	0136 7662 080	0136 7663 080	0136 7664 080	0136 7665 080	0136 7666 080	0136 7667 080
	TORRO SPIRO 80-100/12	80-100	3 1/8-3 15/16	0136 7662 090	0136 7663 090	0136 7664 090	0136 7665 090	0136 7666 090	0136 7667 090
	TORRO SPIRO 90-110/12	90-110	3 9/16-4 5/16	0136 7662 100	0136 7663 100	0136 7664 100	0136 7665 100	0136 7666 100	0136 7667 100
	TORRO SPIRO 100-120/12	100-120	3 15/16-4 3/4	0136 7662 110	0136 7663 110	0136 7664 110	0136 7665 110	0136 7666 110	0136 7667 110
	TORRO SPIRO 110-130/12	110-130	4 5/16-5 1/8	0136 7662 120	0136 7663 120	0136 7664 120	0136 7665 120	0136 7666 120	0136 7667 120
	TORRO SPIRO 120-140/12	120-140	4 3/4-5 1/2	0136 7662 130	0136 7663 130	0136 7664 130	0136 7665 130	0136 7666 130	0136 7667 130
	TORRO SPIRO 130-150/12	130-150	5 1/8-5 15/16	0136 7662 140	0136 7663 140	0136 7664 140	0136 7665 140	0136 7666 140	0136 7667 140
TORRO SPIRO 140-160/12	140-160	5 1/2-6 5/16	0136 7662 150	0136 7663 150	0136 7664 150	0136 7665 150	0136 7666 150	0136 7667 150	



Refer to page 191.

Safety collar



The NORMACLAMP® TORRO® safety collar is a plastic ring that can be attached easily to the bolt head of the clamp. By preventing the screwdriver from slipping off the head, it makes the installation process considerably easier. The safety collar is available for bolts that correspond to wrench opening 7.

Advantages at a glance

- Screwdriver prevented from slipping during installation

Materials

- For all materials

NORMACLAMP® TORRO® SAFETY COLLAR		
Width	Designation	For all Materials Product No.
9/12	THE SAFETY COLLAR 9/12	0043 0000 364

Gas clamp



The NORMACLAMP® TORRO® Gas clamp has been designed for securing domestic gas and propane hoses. The screw of this clamp cuts itself at a predetermined torque level in order to comply exactly with the values of the standard. The break occurs at a torque of 1.2 Nm.

Advantages at a glance

- Designed in accordance with the standard NF XP D 36-110
- The screw cuts itself when the clamp is fixed on the tube so the tube is secured

Materials

- W3

NORMACLAMP® TORRO® GAS CLAMP				
Width	Designation	Clamping ranges		W3 Product No.
		in mm	in inches	
9	TORRO GAS CLAMP 8-16/9	8-16	5/16-5/8	0126 6221 013
	TORRO GAS CLAMP 16-27/9	16-27	5/8-1 1/16	0126 6221 021



Refer to page 191.



- 1 **Extended bridge**
- 2 **16 mm band width**
 - for applications where harsh torques and contact pressures are required
- 3 **Clamping range stamped on the band**
 - prevention of errors

Worm drive hose clamps

NORMACLAMP HD is suitable for special applications where harsh torques and contact pressures are required. This clamp is an add-on type to our range of worm drive hose clips and therefore only available in 16 mm band width and W4 material quality.

Advantages at a glance

- The extended bridge prevents leaks and hose being damaged

Applications

- Mounting of silicone, plastic and rubber tubing with steel inserts

Materials

Material	Corrosion resistance in salt spray testing
W4	Min. 240 h*

* Max 5% corrosion of the base material allowed

Torques

Band width	Failure torque (min. value)	Recommended tightening torque
16	17 Nm	max. 10 Nm*

* Depending on the type of application

Technical data & Ordering information

NORMACLAMP® HD								
Width	Designation	Clamping ranges		B	h	L	s	W4 Product No.
		in mm	in inches					
16	HD 25-45/16 C8	25-45	1-1 3/4	23.0	13.0	37.0	0.7	0156 7804 035
	HD 32-54/16 C8	32-54	1 1/4-2 1/8	23.0	13.0	37.0	0.7	0156 7804 043
	HD 45-67/16 C8	45-67	1 3/4-2 5/8	23.0	13.0	37.0	0.7	0156 7804 056
	HD 57-79/16 C8	57-79	2 1/4-3 1/8	23.0	13.0	37.0	0.7	0156 7804 068
	HD 70-92/16 C8	70-92	2 3/4-3 5/8	23.0	13.0	37.0	0.7	0156 7804 081
	HD 83-105/16 C8	83-105	3 1/4-4 1/8	23.0	13.0	37.0	0.7	0156 7804 094
	HD 95-118/16 C8	95-118	3 3/4-4 5/8	23.0	13.0	37.0	0.7	0156 7804 106
	HD 108-130/16 C8	108-130	4 1/4-5 1/8	23.0	13.0	37.0	0.7	0156 7804 119
	HD 121-143/16 C8	121-143	4 3/4-5 5/8	23.0	13.0	37.0	0.7	0156 7804 132
	HD 133-156/16 C8	133-156	5 1/4-6 1/8	23.0	13.0	37.0	0.7	0156 7804 144
	HD 146-168/16 C8	146-168	5 3/4-6 5/8	23.0	13.0	37.0	0.7	0156 7804 157
	HD 159-181/16 C8	159-181	6 1/4-7 1/8	23.0	13.0	37.0	0.7	0156 7804 170
	HD 172-194/16 C8	172-194	6 3/4-7 5/8	23.0	13.0	37.0	0.7	0156 7804 183
	HD 184-206/16 C8	184-206	7 1/4-8 1/8	23.0	13.0	37.0	0.7	0156 7804 195
	HD 197-219/16 C8	197-219	7 3/4-8 5/8	23.0	13.0	37.0	0.7	0156 7804 208
	HD 210-232/16 C8	210-232	8 1/4-9 1/8	23.0	13.0	37.0	0.7	0156 7804 221

Other sizes available on request

Refer to page 191.

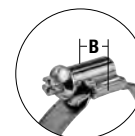

B = overall width
housing



h = overall height
bolt and housing



L = overall length
bolt and housing

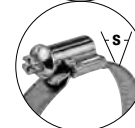

s = band thickness
clamp band

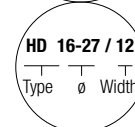

Name structure
clamp band

HI-TORQUE CLAMP

Worm Drive Hose Clamps - Perforated band

NORMACLAMP®



- 1 Screw housing for easy tightening
- 2 'In-line' housing, which enables every thread on the worm to engage with the band
- 3 Perforated band

Signage clamp

The Hi-Torque Signage Clamp is produced using components entirely manufactured from stainless steel. The construction of the worm-drive housing on the band facilitates installation of a wide range of signs. Hi-Torque clamps are reusable and easy to retighten after expansion

caused by temperature fluctuations, and their construction ensures that during installation there are no sharp edges which might cause injury to the installer. The recommended tightening torque for secure and reliable installation is 16 Nm and the breaking torque is more than 20 Nm.

Advantages at a glance

- Reusable
- Secure and reliable installation
- Easy to retighten in cases of expansion (due to temperature fluctuations)
- No loss of material when installing
- Easy installation of two signs on one pole

Applications

- Traffic signs, street signs, billboards and illuminated signs installation
- Heavy duty sealing applications
- Agricultural
- Chemical Industry
- Food Processing
- Fluid Transfer
- Marine Industry
- Petrochemical Industry
- Shipyards

Materials

W1	W2	W3	W4	W5
			x	

Technical data & Ordering information

NORMACLAMP® HI-TORQUE				
Width	Designation	Clamping ranges		W4
		in mm	in inches	Product No.
16	HI-TORQUE 32-67/16	32-67	1 1/4-2 5/8	0560 6610 050
	HI-TORQUE 54-105/16	54-105	2 1/8-4 1/8	0560 6610 080
	HI-TORQUE 102-156/16	102-156	4-6 1/8	0560 6610 129
	HI-TORQUE 156-232/16	156-232	6 1/8-9 1/8	0560 6610 194
	HI-TORQUE 229-384/16	229-384	9-15 1/8	0560 6610 307



Refer to page 191.

QUICK LOCK 9 MM

Worm Drive Hose Clamps - Quick Lock

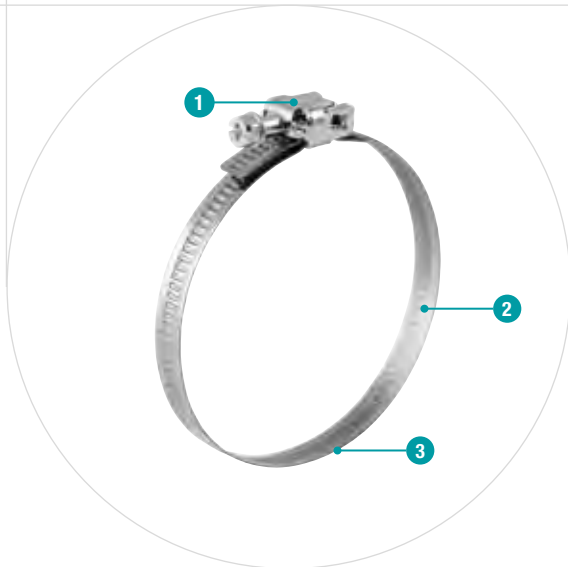

- 1 Tilting housing with screw
- 2 Smooth inner band
- 3 Round edges to prevent damages to the pipe

Automatic locking clamp

NORMACLAMP® Quick lock 9 mm is manufactured from a continuously threaded band with flat edges and a smooth inside to prevent damages to the pipe. The system of the tilting housing with the screw allows easy

and quick application due to the automatic locking that forms the right diameter for the pipe. Band thickness 0.6 mm for band width 9 mm.

Advantages at a glance

- Easy and quick application
- Safe joint with the hose
- Flexibility
- Clamping range from 25-40 up to 60-1300 mm

Applications

- Water industry
- Air conditioning
- Construction
- Sanitary

Materials

W1	W2 (B) *	W3	W4	W5
	x		x	

*W2 (B): Band in stainless steel (W3)
Screw and housing in galvanized steel (W1)
W2 (B) is a combination of W1 and W3 materials

Torques

Band width	Tightening torque	Tightening speed
9	2.5 +0.5 Nm	Max. 50 RPM

Technical data & Ordering information

NORMACLAMP® QUICK LOCK 9 MM					
Width	Designation	Clamping ranges		W2 (B) Product No.	W4 Product No.
		in mm	in inches		
9	QUICK LOCK 25-40/9	25-40	1-1 9/16	0815 6120 040	
	QUICK LOCK 25-45/9	25-45	1-1 3/4	0815 6120 045	
	QUICK LOCK 32-50/9	32-50	1 1/4-2	0815 6120 050	
	QUICK LOCK 40-60/9	40-60	1 9/16-2 3/8	0815 6120 060	
	QUICK LOCK 50-70/9	50-70	2-2 3/4	0815 6120 070	
	QUICK LOCK 60-80/9	60-80	2 3/8-3 1/8	0815 6120 080	
	QUICK LOCK 60-90/9	60-90	2 3/8-3 9/16	0815 6120 090	
	QUICK LOCK 60-100/9	60-100	2 3/8-3 15/16	0815 6120 100	
	QUICK LOCK 60-110/9	60-110	2 3/8-4 5/16	0815 6120 110	0815 6130 110
	QUICK LOCK 60-125/9	60-125	2 3/8-4 15/16	0815 6120 125	
	QUICK LOCK 60-135/9	60-135	2 3/8-5 5/16	0815 6120 135	0815 6130 135
	QUICK LOCK 60-145/9	60-145	2 3/8-5 11/16	0815 6120 145	0815 6130 145
	QUICK LOCK 60-165/9	60-165	2 3/8-6 1/2	0815 6120 165	
	QUICK LOCK 60-170/9	60-170	2 3/8-6 11/16		0815 6130 170
	QUICK LOCK 60-175/9	60-175	2 3/8-6 7/8	0815 6120 175	
	QUICK LOCK 60-215/9	60-215	2 3/8-8 7/16	0815 6120 215	0815 6130 215
	QUICK LOCK 60-270/9	60-270	2 3/8-10 5/8	0815 6120 270	0815 6130 270
	QUICK LOCK 60-280/9	60-280	2 3/8-11	0815 6120 280	
	QUICK LOCK 60-290/9	60-290	2 3/8-11 7/16	0815 6120 290	
	QUICK LOCK 60-325/9	60-325	2 3/8-12 13/16	0815 6120 325	0815 6130 325
	QUICK LOCK 60-370/9	60-370	2 3/8-14 9/16	0815 6120 370	
	QUICK LOCK 60-380/9	60-380	2 3/8- 14 15/16	0815 6120 380	0815 6130 380
	QUICK LOCK 60-425/9	60-425	2 3/8-16 3/4	0815 6120 425	0815 6130 425
	QUICK LOCK 60-525/9	60-525	2 3/8-20 11/16	0815 6120 525	0815 6130 525
	QUICK LOCK 60-630/9	60-630	2 3/8-24 13/16	0815 6120 630	
	QUICK LOCK 60-660/9	60-660	2 3/8-26	0815 6120 660	0815 6130 660
	QUICK LOCK 60-1050/9	60-1050	2 3/8-41 5/16	0815 6121 050	
	QUICK LOCK 60-1300/9	60-1300	2 3/8-51 3/16	0815 6121 300	

Additional diameters on request



Refer to page 191.

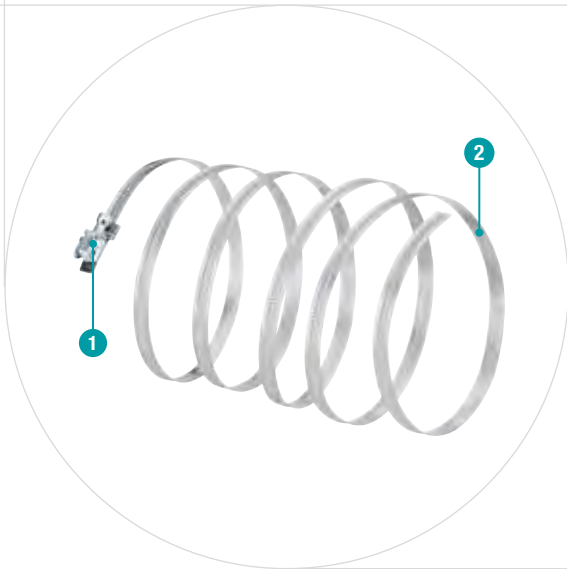

- 1 Tilting housing with screw – Quick lock system
- 2 Perforated band to provide an ideal contact surface for the hose

The clamp for large hoses

NORMACLAMP® Quick lock 12 mm is designed for quick-lock tightening and releasing of large diameter hoses and supplied in a perforated band, to provide an ideal contact surface for the hose. This clamp is the ideal solution for larger hose diameters over 100 mm. Band thickness 0.7 mm for band width 12 mm assures a very flexible clamp.

Advantages at a glance

- The quick lock housing eases the assembly of the clamp
- Safe joint with the hose
- Flexibility
- Wide clamping range

Applications

- Water industry
- Air conditioning
- Construction
- Sanitary

Materials

W1	W2 (B) *	W3	W4	W5
	x			

*W2 (B): Band in stainless steel (W3)
Screw and housing in galvanized steel (W1)
W2 (B) is a combination of W1 and W3 materials

Technical data & Ordering information

NORMACLAMP® QUICK LOCK 12 MM				
Width	Designation	Clamping ranges		W2 (B) Product No.
		in mm	in inches	
12	QUICK LOCK 50-110/12	50-110	2-4 5/16	0815 6020 080
	QUICK LOCK 50-130/12	50-130	2-5 1/8	0815 6020 090
	QUICK LOCK 50-145/12	50-145	2-5 11/16	0815 6020 098
	QUICK LOCK 50-165/12	50-165	2-6 1/2	0815 6020 108
	QUICK LOCK 50-175/12	50-175	2-6 7/8	0815 6020 113
	QUICK LOCK 50-215/12	50-215	2-8 7/16	0815 6020 133
	QUICK LOCK 50-280/12	50-280	2-11	0815 6020 165
	QUICK LOCK 50-325/12	50-325	2-12 13/16	0815 6020 188
	QUICK LOCK 50-370/12	50-370	2-14 9/16	0815 6020 210
	QUICK LOCK 50-425/12	50-425	2-16 3/4	0815 6020 238
	QUICK LOCK 60-525/12	60-525	2-20 11/16	0815 6020 293
	QUICK LOCK 70-625/12	70-625	2-24 5/8	0815 6020 348



Refer to pages 180, 187 and 191.



- 1 Dispenser for 9 mm band width (stamped band)
- 2 Dispenser for 12 mm band width (perforated band)

Continuous band for multiple clamp diameters

The NORMACLAMP® Strip steel is a perfect solution for creating clamps with different diameters depending on a user's needs. Strip steel is a long continuous band available in 9 or 12 mm band width. For closing the clamp use the NORMACLAMP® Quick lock housing 9 or 12 mm.

Advantages at a glance

- Variability
- Flexibility
- Storage and inventory benefit
- Allows making up to 44 clamps

Applications

- Water industry
- Air conditioning
- Construction
- Sanitary

Materials

W1	W2 (B) *	W3	W4	W5
	x		x	

*W2 (B): Band in stainless steel (W3)
Screw and housing in galvanized steel (W1)
W2 (B) is a combination of W1 and W3 materials

Technical data & Ordering information

NORMACLAMP® STRIP STEEL					
Width	Designation	Length		W2 (B) Product No.	W4 Product No.
		in m	in inch		
9	STRIP STEEL 9 25 MTS	25	98 7/16	0815 7121 005	0815 7131 005
	STRIP STEEL 9 30 MTS	30	118 1/8	0815 7121 008	0815 7131 008
12	STRIP STEEL 12 25 MTS	25	98 7/16	0815 0007 006	



Refer to page 191.

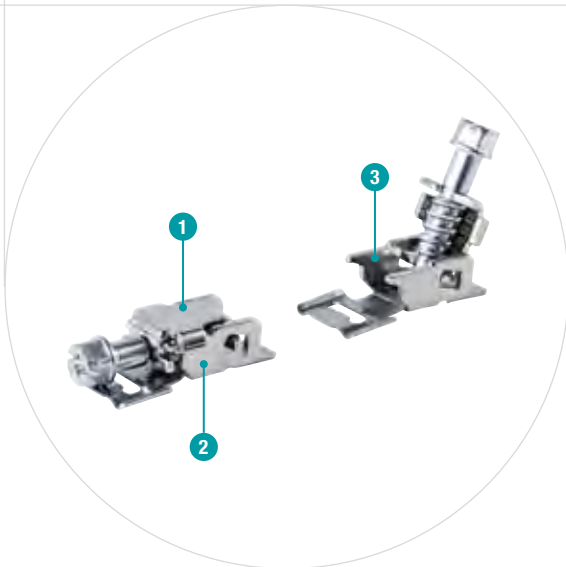

- 1 Tilting housing with screw
- 2 Closed position
- 3 Opened position

Locking system for continuous band

THE NORMACLAMP® Quick lock housing 9 and 12 mm are used to close the NORMACLAMP® Strip steel.

Advantages at a glance

- Fast, simple and safe assembly
- Enables the closing of clamps of many diameters

Applications

- Water industry
- Air conditioning
- Construction
- Sanitary

Materials

W1	W2 (B) *	W3	W4	W5
	x		x	

*W2 (B): Band in stainless steel (W3)
 Screw and housing in galvanized steel (W1)
 W2 (B) is a combination of W1 and W3 materials

Technical data & Ordering information

NORMACLAMP® QUICK LOCK HOUSING			
Width	Designation	W2 (B) Product No.	W4 Product No.
9	QUICK LOCK HOUSING 9	0815 7121 007	0815 7131 007
12	QUICK LOCK HOUSING 12	0815 6007 008	



Refer to page 191.



- 1 Bolt**
– New specially designed bolt with integrated spacer and improved performance. The W5 version has a socket head cap bolt
- 2 Reinforced band loops**
– ability to withstand much higher torques
- 3 Mechanically locked closure**
– no welding spots and no contact corrosion
- 4 Bridge**
– hose protection
- 5 Robust band with rounded edges**
– prevents injuries and damage to hoses
- 6 Hollow trunnions**
– reduces the tensile forces on the bolt and the mechanical lock

Heavy-duty clamps for multiple applications

NORMACLAMP® GBS is designed primarily for use in applications where hose clamps must meet stringent requirements. In particular if suction and pressure hoses - complete with plastic or steel inserts and high shore hardness values - are to be connected and attached. They are therefore particularly suitable for use on commercial and special vehicles. Their standout feature is the exceptionally high levels of band tensile force they demonstrate. NORMACLAMP® GBS clamps are also extremely easy to install, whether you're using manual, pneumatic or electrical standard tools.



Advantages at a glance

- Failure torques improved by a factor of two
- Band tensile force levels improved by a factor of three

Applications

- Machine building
- Chemical industry
- Irrigation systems
- Ship manufacturing
- Railway industry
- Agricultural machines
- Building machines
- Engine manufacturing
- Pump and filter
- Mining Industry

Materials

W1	W2	W3	W4	W5
x	x		x	x

Material	Corrosion resistance in salt spray testing
W1	Min. 72 h
W2	Min. 72 h
W4	Min. 240 h
W5	Min. 400 h

NORMACLAMP® GBS						
Band width	Material thickness in mm					
	W1	W2	W4	W5	M	SW
18	0.8	0.6	0.6	0.6	6	8
20	1.0	0.8	0.8	0.8	7	10
25	1.0	1.0	1.0	1.0	8	13
30	1.3	1.0	1.0	1.0	10	17

Band tensile force

The results of numerous series of tests have underlined the technical superiority of NORMACLAMP® GBS products over their competitors:

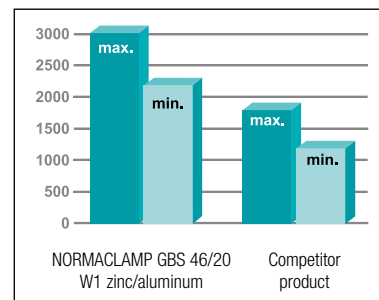

Table of torques

NORMACLAMP® GBS					
Band width	Failure torque (minimum) Nm				Recommended tightening torque Nm
	W1	W2	W4	W5	
18	15	15	15	15	8
20	25	20	20	20	10
25	35	30	30	30	20
30	50	45	45	45	25

NORMACLAMP® GBS RUBBER INSERT			
Band width	Failure torque (minimum) Nm		Recommended tightening torque Nm
	W1	W2	
18	10	10	6
20	15	15	8
25	25	25	18
30	40	40	22

Technical data & Ordering information

NORMACLAMP® GBS HOLLOW TRUNNION							
Width	Designation	Clamping ranges		W1 Product No.	W2 Product No.	W4 Product No.	W5 Product No.
		in mm	in inches				
18	GBS M17-19/18 Sk*	17-19	11/16-3/4	0591 7181 018	0591 7182 018	0591 7184 018	0591 7185 018
	GBS M19-21/18 Sk*	19-21	3/4-13/16	0591 7181 020	0591 7182 020	0591 7184 020	0591 7185 020
	GBS M21-23/18 Sk*	21-23	13/16-15/16	0591 7181 022	0591 7182 022	0591 7184 022	0591 7185 022
	GBS M23-25/18 Sk*	23-25	15/16-1	0591 7181 024	0591 7182 024	0591 7184 024	0591 7185 024
	GBS M25-27/18 Sk	25-27	1-1 1/16	0591 7181 026	0591 7182 026	0591 7184 026	0591 7185 026
	GBS M27-29/18 Sk	27-29	1 1/16-1 1/8	0591 7181 028	0591 7182 028	0591 7184 028	0591 7185 028
	GBS M29-31/18 Sk	29-31	1 1/8-1 1/4	0591 7181 030	0591 7182 030	0591 7184 030	0591 7185 030
	GBS M31-34/18 Sk	31-34	1 1/4-1 5/16	0591 7181 033	0591 7182 033	0591 7184 033	0591 7185 033
	GBS M34-37/18 Sk	34-37	1 5/16-1 7/16	0591 7181 036	0591 7182 036	0591 7184 036	0591 7185 036
	GBS M37-40/18 Sk	37-40	1 7/16-1 9/16	0591 7181 039	0591 7182 039	0591 7184 039	0591 7185 039
GBS M40-43/18 Sk	40-43	1 9/16-1 11/16	0591 7181 042	0591 7182 042	0591 7184 042	0591 7185 042	
20	GBS M43-47/20 Sk	43-47	1 11/16-1 7/8	0591 7201 045	0591 7202 045	0591 7204 045	0591 7205 045
	GBS M47-51/20 Sk	47-51	1 7/8-2	0591 7201 049	0591 7202 049	0591 7204 049	0591 7205 049
	GBS M51-55/20 Sk	51-55	2-2 3/16	0591 7201 053	0591 7202 053	0591 7204 053	0591 7205 053
	GBS M55-59/20 Sk	55-59	2 3/16-2 5/16	0591 7201 057	0591 7202 057	0591 7204 057	0591 7205 057
	GBS M59-63/20 Sk	59-63	2 5/16-2 1/2	0591 7201 061	0591 7202 061	0591 7204 061	0591 7205 061
	GBS M63-68/20 Sk	63-68	2 1/2-2 11/16	0591 7201 066	0591 7202 066	0591 7204 066	0591 7205 066
25	GBS M68-73/25 Sk	68-73	2 11/16-2 7/8	0591 7251 071	0591 7252 071	0591 7254 071	0591 7255 071
	GBS M73-79/25 Sk	73-79	2 7/8-3 1/8	0591 7251 076	0591 7252 076	0591 7254 076	0591 7255 076
	GBS M79-85/25 Sk	79-85	3 1/8-3 3/8	0591 7251 082	0591 7252 082	0591 7254 082	0591 7255 082
	GBS M85-91/25 Sk	85-91	3 3/8-3 9/16	0591 7251 088	0591 7252 088	0591 7254 088	0591 7255 088
	GBS M91-97/25 Sk	91-97	3 9/16-3 13/16	0591 7251 094	0591 7252 094	0591 7254 094	0591 7255 094
	GBS M97-104/25 Sk	97-104	3 13/16-4 1/6	0591 7251 101	0591 7252 101	0591 7254 101	0591 7255 101
	GBS M104-112/25 Sk	104-112	4 1/16-4 7/16	0591 7251 108	0591 7252 108	0591 7254 108	0591 7255 108
	GBS M112-121/25 Sk	112-121	4 7/16-4 3/4	0591 7251 117	0591 7252 117	0591 7254 117	0591 7255 117
	GBS M121-130/25 Sk	121-130	4 3/4-5 1/8	0591 7251 126	0591 7252 126	0591 7254 126	0591 7255 126
	30	GBS M130-140/30 Sk	130-140	5 1/8-5 1/2	0591 7301 135	0591 7302 135	0591 7304 135
GBS M140-150/30 Sk		140-150	5 1/2-5 15/16	0591 7301 145	0591 7302 145	0591 7304 145	0591 7305 145
GBS M150-162/30 Sk		150-162	5 15/16-6 3/8	0591 7301 156	0591 7302 156	0591 7304 156	0591 7305 156
GBS M162-174/30 Sk		162-174	6 3/8-6 7/8	0591 7301 168	0591 7302 168	0591 7304 168	0591 7305 168
GBS M174-187/30 Sk		174-187	6 7/8-7 3/8	0591 7301 181	0591 7302 181	0591 7304 181	0591 7305 181
GBS M187-200/30 Sk		187-200	7 3/8-7 7/8	0591 7301 194	0591 7302 194	0591 7304 194	0591 7305 194
GBS M200-213/30 Sk		200-213	7 7/8-8 3/8	0591 7301 207	0591 7302 207	0591 7304 207	0591 7305 207
GBS M213-226/30 Sk		213-226	8 3/8-8 7/8	0591 7301 220	0591 7302 220	0591 7304 220	0591 7305 220
GBS M226-239/30 Sk		226-239	8 7/8-9 7/16	0591 7301 233	0591 7302 233	0591 7304 233	0591 7305 233
GBS M239-252/30 Sk		239-252	9 7/16-9 15/16	0591 7301 246	0591 7302 246	0591 7304 246	0591 7305 246
GBS M252-265/30 Sk		252-265	9 15/16-10 7/16	0591 7301 259	0591 7302 259	0591 7304 259	0591 7305 259
GBS M265-278/30 Sk		265-278	10 7/16-10 15/16	0591 7301 272	0591 7302 272	0591 7304 272	0591 7305 272
GBS M279-291/30 Sk		279-291	11-11 7/16	0591 7301 285	0591 7302 285	0591 7304 285	0591 7305 285
GBS M292-304/30 Sk		292-304	11 1/2-12	0591 7301 298	0591 7302 298	0591 7304 298	0591 7305 298

These diameters are full trunnions and do not feature a mechanically locked closure, but are instead spot-welded.



Refer to page 187.

Solid trunnions – STC



To suit the requirements of all markets, NORMACLAMP® GBS is also available with solid trunnions.

Advantages at a glance

- Strong robustness

Materials

- W1, W4

NORMACLAMP® GBS STC

Width	Description	Clamping range		W1 Product No.	W4 Product No.
		in mm	in inches		
18	GBS M17-19/18 STC	17 - 19	11/16-3/4	0591 7001 018	0591 7009 018
	GBS M19-21/18 STC	19 - 21	3/4-13/16	0591 7001 020	0591 7009 020
	GBS M21-23/18 STC	21 - 23	13/16-15/16	0591 7001 022	0591 7009 022
	GBS M23-25/18 STC	23 - 25	15/16-1	0591 7001 024	0591 7009 024
	GBS M25-27/18 STC	25 - 27	1-1 1/16	0591 7001 026	0591 7009 026
	GBS M27-29/18 STC	27 - 29	1 1/16-1 1/8	0591 7001 028	0591 7009 028
	GBS M29-31/18 STC	29 - 31	1 1/8-1 1/4	0591 7001 030	0591 7009 030
	GBS M31-34/18 STC	31 - 34	1 1/4-1 5/16	0591 7001 033	0591 7009 033
	GBS M34-37/18 STC	34 - 37	1 5/16-1 7/16	0591 7001 036	0591 7009 036
	GBS M37-40/18 STC	37 - 40	1 7/16-1 9/16	0591 7001 039	0591 7009 039
GBS M40-43/18 STC	40 - 43	1 9/16-1 11/16	0591 7001 042	0591 7009 042	
20	GBS M43-47/20 STC	43 - 47	1 11/16-2 7/8	0591 7002 045	0591 7010 045
	GBS M47-51/20 STC	47 - 51	1 7/8-2	0591 7002 049	0591 7010 049
	GBS M51-55/20 STC	51 - 55	2-2 3/16	0591 7002 053	0591 7010 053
	GBS M55-59/20 STC	55 - 59	2 3/16-2 5/16	0591 7002 057	0591 7010 057
	GBS M59-63/20 STC	59 - 63	2 5/16-2 1/2	0591 7002 061	0591 7010 061
	GBS M63-68/20 STC	63 - 68	2 1/2-2 11/16	0591 7002 066	0591 7010 066
25	GBS M68-73/25 STC	68 - 63	2 11/16-2 7/8	0591 7003 071	0591 7011 071
	GBS M73-79/25 STC	73 - 79	2 7/8-3 1/8	0591 7003 076	0591 7011 076
	GBS M79-85/25 STC	79 - 85	3 1/8-3 3/8	0591 7003 082	0591 7011 082
	GBS M85-91/25 STC	85 - 91	3 3/8-3 9/16	0591 7003 088	0591 7011 088
	GBS M91-97/25 STC	91 - 97	3 9/16-3 13/16	0591 7003 094	0591 7011 094
	GBS M97-104/25 STC	97 - 104	3 13/16-4 1/6	0591 7003 101	0591 7011 101
	GBS M104-112/25 STC	104 - 112	4 1/16-4 7/16	0591 7003 108	0591 7011 108
	GBS M112-121/25 STC	112 - 121	4 7/16-4 3/4	0591 7003 117	0591 7011 117
GBS M121-130/25 STC	121 - 130	4 3/4-5 1/8	0591 7003 126	0591 7011 126	
30	GBS M130-140/30 STC	130 - 140	5 1/8-5 1/2	0591 7004 135	0591 7012 135
	GBS M140-150/30 STC	140 - 150	5 1/2-5 15/16	0591 7004 145	0591 7012 145
	GBS M150-162/30 STC	150 - 162	5 15/16-6 3/8	0591 7004 156	0591 7012 156
	GBS M162-174/30 STC	162 - 174	6 3/8-6 7/8	0591 7004 168	0591 7012 168
	GBS M174-187/30 STC	174 - 187	6 7/8-7 3/8	0591 7004 181	0591 7012 181
	GBS M187-200/30 STC	187 - 200	7 3/8-7 7/8	0591 7004 194	0591 7012 194
	GBS M200-213/30 STC	200 - 213	7 7/8-8 3/8	0591 7004 207	0591 7012 207
	GBS M213-226/30 STC	213 - 226	8 3/8-8 7/8	0591 7004 220	0591 7012 220
	GBS M226-239/30 STC	226 - 239	8 7/8-9 7/16	0591 7004 233	0591 7012 233
	GBS M239-252/30 STC	239 - 252	9 7/16-9 15/16	0591 7004 246	0591 7012 246
	GBS M252-265/30 STC	252 - 265	9 15/16-10 7/16	0591 7004 259	0591 7012 259
	GBS M265-278/30 STC	265 - 278	10 7/16-10 15/16	0591 7004 272	0591 7012 272
	GBS M278-291/30 STC	278 - 291	10 15/16-11 7/16	0591 7004 285	0591 7012 285
	GBS M291-304/30 STC	291 - 304	11 7/16-12	0591 7004 298	0591 7012 298
GBS M304-317/30 STC	304 - 317	12-12 1/2	0591 7004 311	0591 7012 311	
GBS M317-330/30 STC	317 - 330	12 1/2-13	0591 7004 324	0591 7012 324	

QRC closure



NORMACLAMP® GBS is also available with a Quick Release Closure. The bolt on the closure is easy to release, ensuring straightforward installation and removal.

Advantages at a glance

- Easy to install

Materials

- W1, W2

NORMACLAMP® GBS QRC					
Width	Description	Clamping range		W1 Product No.	W2 Product No.
		in mm	in inches		
18	GBS M17-19/18 Zy QRC*	17 - 19	11/16-3/4	0592 7181 018	0592 7182 018
	GBS M19-21/18 Zy QRC*	19 - 21	3/4-13/16	0592 7181 020	0592 7182 020
	GBS M21-23/18 Zy QRC*	21 - 23	13/16-15/16	0592 7181 022	0592 7182 022
	GBS M23-25/18 Zy QRC*	23 - 25	15/16-1	0592 7181 024	0592 7182 024
	GBS M25-27/18 Zy QRC	25 - 27	1-1 1/16	0592 7181 026	0592 7182 026
	GBS M27-29/18 Zy QRC	27 - 29	1 1/16-1 1/8	0592 7181 028	0592 7182 028
	GBS M29-31/18 Zy QRC	29 - 31	1 1/8-1 1/4	0592 7181 030	0592 7182 030
	GBS M31-34/18 Zy QRC	31 - 34	1 1/4-1 5/16	0592 7181 033	0592 7182 033
	GBS M34-37/18 Zy QRC	34 - 37	1 5/16-1 7/16	0592 7181 036	0592 7182 036
	GBS M37-40/18 Zy QRC	37 - 40	1 7/16-1 9/16	0592 7181 039	0592 7182 039
GBS M40-43/18 Zy QRC	40 - 43	1 9/16-1 11/16	0592 7181 042	0592 7182 042	
20	GBS M43-47/20 Zy QRC	43 - 47	1 11/16-1 7/8	0592 7201 045	0592 7202 045
	GBS M47-51/20 Zy QRC	47 - 51	1 7/8-2	0592 7201 049	0592 7202 049
	GBS M51-55/20 Zy QRC	51 - 55	2-2 3/16	0592 7201 053	0592 7202 053
	GBS M55-59/20 Zy QRC	55 - 59	2 3/16-2 5/16	0592 7201 057	0592 7202 057
	GBS M59-63/20 Zy QRC	59 - 63	2 5/16-2 1/2	0592 7201 061	0592 7202 061
	GBS M63-68/20 Zy QRC	63 - 68	2 1/2-2 11/16	0592 7201 066	0592 7202 066
25	GBS M68-73/25 Zy QRC	68 - 73	2 11/16-2 7/8	0592 7251 071	0592 7252 071
	GBS M73-79/25 Zy QRC	73 - 79	2 7/8-3 1/8	0592 7251 076	0592 7252 076
	GBS M79-85/25 Zy QRC	79 - 85	3 1/8-3 3/8	0592 7251 082	0592 7252 082
	GBS M85-91/25 Zy QRC	85 - 91	3 3/8-3 9/16	0592 7251 088	0592 7252 088
	GBS M91-97/25 Zy QRC	91 - 97	3 9/16-3 13/16	0592 7251 094	0592 7252 094
	GBS M97-104/25 Zy QRC	97 - 104	3 13/16-4 1/6	0592 7251 101	0592 7252 101
	GBS M104-112/25 Zy QRC	104 - 112	4 1/16-4 7/16	0592 7251 108	0592 7252 108
	GBS M112-121/25 Zy QRC	112 - 121	4 7/16-4 3/4	0592 7251 117	0592 7252 117
GBS M121-130/25 Zy QRC	121 - 130	4 3/4-5 1/8	0592 7251 126	0592 7252 126	
30	GBS M130-140/30 Zy QRC	130 - 140	5 1/8-5 1/2	0592 7301 135	0592 7302 135
	GBS M140-150/30 Zy QRC	140 - 150	5 1/2-5 15/16	0592 7301 145	0592 7302 145
	GBS M150-162/30 Zy QRC	150 - 162	5 15/16-6 3/8	0592 7301 156	0592 7302 156
	GBS M162-174/30 Zy QRC	162 - 174	6 3/8-6 7/8	0592 7301 168	0592 7302 168
	GBS M174-187/30 Zy QRC	174 - 187	6 7/8-7 3/8	0592 7301 181	0592 7302 181
	GBS M187-200/30 Zy QRC	187 - 200	7 3/8-7 7/8	0592 7301 194	0592 7302 194
	GBS M200-213/30 Zy QRC	200 - 213	7 7/8-8 3/8	0592 7301 207	0592 7302 207
	GBS M213-226/30 Zy QRC	213 - 226	8 3/8-8 7/8	0592 7301 220	0592 7302 220
	GBS M226-239/30 Zy QRC	226 - 239	8 7/8-9 7/16	0592 7301 233	0592 7302 233
	GBS M239-252/30 Zy QRC	239 - 252	9 7/16-9 15/16	0592 7301 246	0592 7302 246

These diameters do not feature a mechanically locked closure, but are instead spot-welded.

Multi-parts



NORMACLAMP® GBS is also available in a multi-part version for bigger diameters.

Advantages at a glance

- Suitable for big diameter hoses

Materials

- W1, W2, W4, W5

NORMACLAMP® GBS MULTI-PARTS

Width	Description	Clamping range		W1 Product No.	W2 Product No.	W4 Product No.	W5 Product No.
		in mm	in inches				
18	GBS M59-67/18 SK 2T	59-67	2 5/16-2 5/8	0591 7191 063	0591 7192 063	0591 7194 063	0591 7195 063
	GBS M67-75/18 SK 2T	67-75	2 5/8-2 15/16	0591 7191 071	0591 7192 071	0591 7194 071	0591 7195 071
20	GBS M67-75/20 SK 2T	67-75	2 5/8-2 15/16	0591 7221 071	0591 7222 071	0591 7224 071	0591 7225 071
	GBS M75-83/20 SK 2T	75-83	2 15/16-3 1/4	0591 7221 079	0591 7222 079	0591 7224 079	0591 7225 079
	GBS M83-91/20 SK 2T	83-91	3 1/4-3 9/16	0591 7221 087	0591 7222 087	0591 7224 087	0591 7225 087
25	GBS M88-100/25 SK 2T	88-100	3 9/16-4	0591 7271 094	0591 7272 094	0591 7274 094	0591 7275 094
	GBS M100-116/25 SK 2T	100-116	3 7/16-4 9/16	0591 7271 108	0591 7272 108	0591 7274 108	0591 7275 108
	GBS M116-136/25 SK 2T	116-136	4 9/16-5 3/8	0591 7271 126	0591 7272 126	0591 7274 126	0591 7275 126
	GBS M136-156/25 SK 2T	136-156	5 3/8-6 1/8	0591 7271 146	0591 7272 146	0591 7274 146	0591 7275 146
	GBS M156-176/25 SK 2T	156-176	6 1/8-6 15/16	0591 7271 168	0591 7272 168	0591 7274 168	0591 7275 168
30	GBS M125-145/30 SK 2T	125-145	4 15/16-5 11/16	0591 7321 135	0591 7322 135	0591 7324 135	0591 7325 135
	GBS M145-168/30 SK 2T	145-168	5 11/16-6 5/8	0591 7321 156	0591 7322 156	0591 7324 156	0591 7325 156
	GBS M168-193/30 SK 2T	168-193	6 5/8-7 5/8	0591 7321 181	0591 7322 181	0591 7324 181	0591 7325 181
	GBS M193-220/30 SK 2T	193-220	7 5/8-8 11/16	0591 7321 207	0591 7322 207	0591 7324 207	0591 7325 207
	GBS M220-245/30 SK 2T	220-245	8 11/16-9 5/8	0591 7321 233	0591 7322 233	0591 7324 233	0591 7325 233
	GBS M245-270/30 SK 2T	245-270	9 5/8-10 5/8	0591 7321 258	0591 7322 258	0591 7324 258	0591 7325 258
	GBS M270-295/30 SK 2T	270-295	10 5/8-11 5/8	0591 7321 283	0591 7322 283	0591 7324 283	0591 7325 283
	GBS M295-320/30 SK 2T	295-320	11 5/8-12 5/8	0591 7321 308	0591 7322 308	0591 7324 308	0591 7325 308
	GBS M320-345/30 SK 2T	320-345	12 5/8-13 9/16	0591 7321 333	0591 7322 333	0591 7324 333	0591 7325 333

Rubber insert



NORMACLAMP® GBS clamps can be delivered with a rubber insert for protecting against vibrations and creeping water, but also for sound absorption. For more information, please contact us.

Ordering information

When submitting requests and orders, please specify the data in the following manner:

	1. Type	2. Clamping range	3. Band width	4. Material	5. Parts
Example	GBS RUBBER-INSERT	43-47	20	W1	1-part

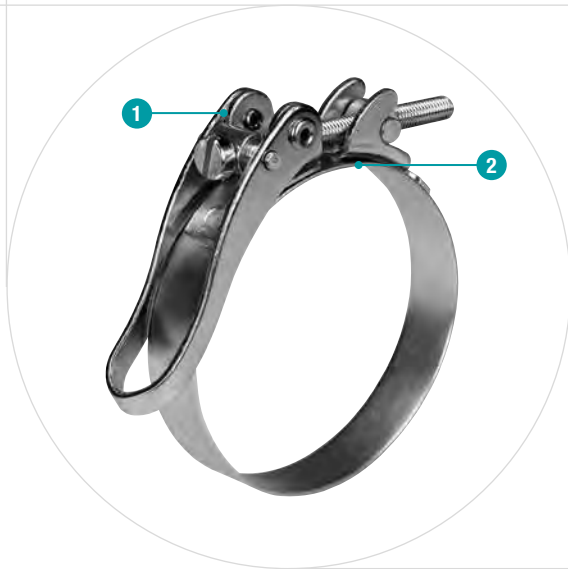

- 1 Quick close and release**
 - Secure over-center lever for manual opening and closing without the need for installation tools
- 2 Bridge**
 - Optimum hose protection

Quick-release clamps

NORMACLAMP® SVS and NORMACLAMP® SVSP clamps are secure, flexible joining elements designed for applications where joints need to be closed and released frequently and quickly, such as filtering and filling systems or food industry pipeline systems that are continually being cleaned.

Advantages at a glance

- Closure can be opened and closed easily by hand
- No installation tools required

Applications

- Machine building
- Chemical industry
- Food and beverage industry
- Railway industry
- Building machines
- Pump and filter

Materials

W1	W2	W3	W4	W5
			x	

Material	Corrosion resistance in salt spray testing
W4	Min. 240 h

Technical data

Quick-release hose clamps (SVS)							
Band width	Minimum \emptyset	Maximum \emptyset	Material	Bolts			Closing force N
				W4	(0e)	Zy \ominus	
15	80	500	0.6	(•)	•	6	80
20	80	500	0.8	(•)	•	6	80
25	80	500	1.0	(•)	•	6	80

Technical data & Ordering information

NORMACLAMP® SVS			
Diameter in mm	Material W4 Product No.		
	Band width		
	15 mm	20 mm	25 mm
80 - 90	0565 0154 ...	0565 0204 ...	0565 0254 ...
up to 100	0565 0154 ...	0565 0204 ...	0565 0254 ...
up to 110	0565 0154 ...	0565 0204 ...	0565 0254 ...
up to 120	0565 0154 ...	0565 0204 ...	0565 0254 ...
up to 130	0565 0154 ...	0565 0204 ...	0565 0254 ...
up to 140	0565 0154 ...	0565 0204 ...	0565 0254 ...
up to 150	0565 0154 ...	0565 0204 ...	0565 0254 ...
up to 160	0565 0154 ...	0565 0204 ...	0565 0254 ...
up to 170	0565 0154 ...	0565 0204 ...	0565 0254 ...
up to 180	0565 0154 ...	0565 0204 ...	0565 0254 ...
up to 190	0565 0154 ...	0565 0204 ...	0565 0254 ...
up to 200	0565 0154 ...	0565 0204 ...	0565 0254 ...
up to 210	0565 0154 ...	0565 0204 ...	0565 0254 ...
up to 220	0565 0154 ...	0565 0204 ...	0565 0254 ...
up to 230	0565 0154 ...	0565 0204 ...	0565 0254 ...
up to 240	0565 0154 ...	0565 0204 ...	0565 0254 ...
up to 250	0565 0154 ...	0565 0204 ...	0565 0254 ...
up to 260	0565 0154 ...	0565 0204 ...	0565 0254 ...
up to 270	0565 0154 ...	0565 0204 ...	0565 0254 ...
up to 280	0565 0154 ...	0565 0204 ...	0565 0254 ...
up to 290	0565 0154 ...	0565 0204 ...	0565 0254 ...
up to 300	0565 0154 ...	0565 0204 ...	0565 0254 ...
up to 310	0565 0154 ...	0565 0204 ...	0565 0254 ...
up to 320	0565 0154 ...	0565 0204 ...	0565 0254 ...
up to 330	0565 0154 ...	0565 0204 ...	0565 0254 ...
up to 340	0565 0154 ...	0565 0204 ...	0565 0254 ...
up to 350	0565 0154 ...	0565 0204 ...	0565 0254 ...
up to 360	0565 0154 ...	0565 0204 ...	0565 0254 ...
up to 370	0565 0154 ...	0565 0204 ...	0565 0254 ...
up to 380	0565 0154 ...	0565 0204 ...	0565 0254 ...
up to 390	0565 0154 ...	0565 0204 ...	0565 0254 ...
up to 400	0565 0154 ...	0565 0204 ...	0565 0254 ...
up to 410	0565 0154 ...	0565 0204 ...	0565 0254 ...
up to 420	0565 0154 ...	0565 0204 ...	0565 0254 ...
up to 430	0565 0154 ...	0565 0204 ...	0565 0254 ...
up to 440	0565 0154 ...	0565 0204 ...	0565 0254 ...
up to 450	0565 0154 ...	0565 0204 ...	0565 0254 ...
up to 460	0565 0154 ...	0565 0204 ...	0565 0254 ...
up to 470	0565 0154 ...	0565 0204 ...	0565 0254 ...
up to 480	0565 0154 ...	0565 0204 ...	0565 0254 ...
up to 490	0565 0154 ...	0565 0204 ...	0565 0254 ...
up to 500	0565 0154 ...	0565 0204 ...	0565 0254 ...

... = Ø without decimals in mm

SVS P



NORMACLAMP SVS clamps feature a bridge, which is ideal for clamping a hose type connection. The SVS P clamp has no bridge.

Advantages at a glance

- As it has no bridge, there is a possibility of having a profile welded onto it

Materials

- W4

NORMACLAMP® SVS P			
Diameter in mm	Material W4 Product No.		
	Band width		
	15 mm	20 mm	25 mm
80 - 90	0566 0154 ...	0566 0204 ...	0566 0254 ...
up to 100	0566 0154 ...	0566 0204 ...	0566 0254 ...
up to 110	0566 0154 ...	0566 0204 ...	0566 0254 ...
up to 120	0566 0154 ...	0566 0204 ...	0566 0254 ...
up to 130	0566 0154 ...	0566 0204 ...	0566 0254 ...
up to 140	0566 0154 ...	0566 0204 ...	0566 0254 ...
up to 150	0566 0154 ...	0566 0204 ...	0566 0254 ...
up to 160	0566 0154 ...	0566 0204 ...	0566 0254 ...
up to 170	0566 0154 ...	0566 0204 ...	0566 0254 ...
up to 180	0566 0154 ...	0566 0204 ...	0566 0254 ...
up to 190	0566 0154 ...	0566 0204 ...	0566 0254 ...
up to 200	0566 0154 ...	0566 0204 ...	0566 0254 ...
up to 210	0566 0154 ...	0566 0204 ...	0566 0254 ...
up to 220	0566 0154 ...	0566 0204 ...	0566 0254 ...
up to 230	0566 0154 ...	0566 0204 ...	0566 0254 ...
up to 240	0566 0154 ...	0566 0204 ...	0566 0254 ...
up to 250	0566 0154 ...	0566 0204 ...	0566 0254 ...
up to 260	0566 0154 ...	0566 0204 ...	0566 0254 ...
up to 270	0566 0154 ...	0566 0204 ...	0566 0254 ...
up to 280	0566 0154 ...	0566 0204 ...	0566 0254 ...
up to 290	0566 0154 ...	0566 0204 ...	0566 0254 ...
up to 300	0566 0154 ...	0566 0204 ...	0566 0254 ...
up to 310	0566 0154 ...	0566 0204 ...	0566 0254 ...
up to 320	0566 0154 ...	0566 0204 ...	0566 0254 ...
up to 330	0566 0154 ...	0566 0204 ...	0566 0254 ...
up to 340	0566 0154 ...	0566 0204 ...	0566 0254 ...
up to 350	0566 0154 ...	0566 0204 ...	0566 0254 ...
up to 360	0566 0154 ...	0566 0204 ...	0566 0254 ...
up to 370	0566 0154 ...	0566 0204 ...	0566 0254 ...
up to 380	0566 0154 ...	0566 0204 ...	0566 0254 ...
up to 390	0566 0154 ...	0566 0204 ...	0566 0254 ...
up to 400	0566 0154 ...	0566 0204 ...	0566 0254 ...
up to 410	0566 0154 ...	0566 0204 ...	0566 0254 ...
up to 420	0566 0154 ...	0566 0204 ...	0566 0254 ...
up to 430	0566 0154 ...	0566 0204 ...	0566 0254 ...
up to 440	0566 0154 ...	0566 0204 ...	0566 0254 ...
up to 450	0566 0154 ...	0566 0204 ...	0566 0254 ...
up to 460	0566 0154 ...	0566 0204 ...	0566 0254 ...
up to 470	0566 0154 ...	0566 0204 ...	0566 0254 ...
up to 480	0566 0154 ...	0566 0204 ...	0566 0254 ...
up to 490	0566 0154 ...	0566 0204 ...	0566 0254 ...
up to 500	0566 0154 ...	0566 0204 ...	0566 0254 ...

... = Ø without decimals in mm

Eyelet bolt



If requested in the order, and assuming that an appropriate quantity is ordered, the closure can be fitted with an eyelet bolt as an alternative.

Advantages at a glance

- Eyelet bolt suitable for light duty series

Materials

- W4

NORMACLAMP® SVS EYELET BOLT			
Diameter in mm	Material W4		
	Product No.		
	Band width		
	15 mm	20 mm	25 mm
80 - 90	0565 1154 ...	0565 1204 ...	0565 1254 ...
up to 100	0565 1154 ...	0565 1204 ...	0565 1254 ...
up to 110	0565 1154 ...	0565 1204 ...	0565 1254 ...
up to 120	0565 1154 ...	0565 1204 ...	0565 1254 ...
up to 130	0565 1154 ...	0565 1204 ...	0565 1254 ...
up to 140	0565 1154 ...	0565 1204 ...	0565 1254 ...
up to 150	0565 1154 ...	0565 1204 ...	0565 1254 ...
up to 160	0565 1154 ...	0565 1204 ...	0565 1254 ...
up to 170	0565 1154 ...	0565 1204 ...	0565 1254 ...
up to 180	0565 1154 ...	0565 1204 ...	0565 1254 ...
up to 190	0565 1154 ...	0565 1204 ...	0565 1254 ...
up to 200	0565 1154 ...	0565 1204 ...	0565 1254 ...
up to 210	0565 1154 ...	0565 1204 ...	0565 1254 ...
up to 220	0565 1154 ...	0565 1204 ...	0565 1254 ...
up to 230	0565 1154 ...	0565 1204 ...	0565 1254 ...
up to 240	0565 1154 ...	0565 1204 ...	0565 1254 ...
up to 250	0565 1154 ...	0565 1204 ...	0565 1254 ...
up to 260	0565 1154 ...	0565 1204 ...	0565 1254 ...
up to 270	0565 1154 ...	0565 1204 ...	0565 1254 ...
up to 280	0565 1154 ...	0565 1204 ...	0565 1254 ...
up to 290	0565 1154 ...	0565 1204 ...	0565 1254 ...
up to 300	0565 1154 ...	0565 1204 ...	0565 1254 ...
up to 310	0565 1154 ...	0565 1204 ...	0565 1254 ...
up to 320	0565 1154 ...	0565 1204 ...	0565 1254 ...
up to 330	0565 1154 ...	0565 1204 ...	0565 1254 ...
up to 340	0565 1154 ...	0565 1204 ...	0565 1254 ...
up to 350	0565 1154 ...	0565 1204 ...	0565 1254 ...
up to 360	0565 1154 ...	0565 1204 ...	0565 1254 ...
up to 370	0565 1154 ...	0565 1204 ...	0565 1254 ...
up to 380	0565 1154 ...	0565 1204 ...	0565 1254 ...
up to 390	0565 1154 ...	0565 1204 ...	0565 1254 ...
up to 400	0565 1154 ...	0565 1204 ...	0565 1254 ...
up to 410	0565 1154 ...	0565 1204 ...	0565 1254 ...
up to 420	0565 1154 ...	0565 1204 ...	0565 1254 ...
up to 430	0565 1154 ...	0565 1204 ...	0565 1254 ...
up to 440	0565 1154 ...	0565 1204 ...	0565 1254 ...
up to 450	0565 1154 ...	0565 1204 ...	0565 1254 ...
up to 460	0565 1154 ...	0565 1204 ...	0565 1254 ...
up to 470	0565 1154 ...	0565 1204 ...	0565 1254 ...
up to 480	0565 1154 ...	0565 1204 ...	0565 1254 ...
up to 490	0565 1154 ...	0565 1204 ...	0565 1254 ...
up to 500	0565 1154 ...	0565 1204 ...	0565 1254 ...

... = Ø without decimals in mm

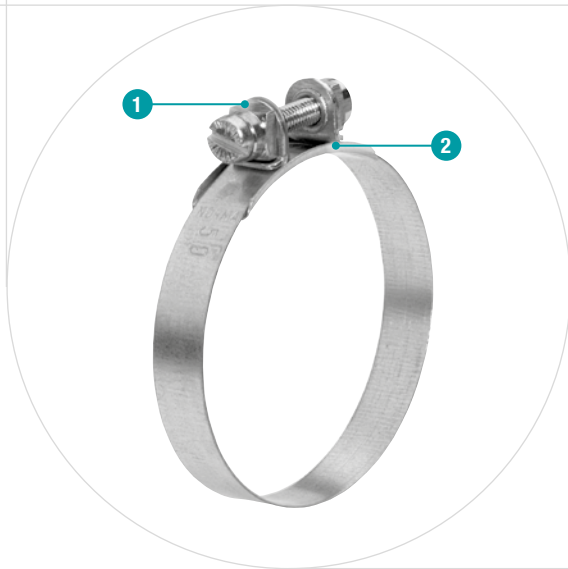

- 1 Powerful clamping brackets structure**
 - high level of clamping force
 - excellent sealing properties
- 2 Bridge**
 - optimum hose protection

DIN 3016, DIN 3017

Thanks to their robust clamping brackets structure featuring metric bolts, NORMACLAMP® S/SP clamps provide a high level of clamping force. The two-part version is recommended for exceptionally high pressure and tensile loads.



Advantages at a glance

- High level of clamping force
- Even contact pressure
- Elbow fittings, brackets or lugs can be attached
- Clamps can be fitted with a rubber profile in order to absorb vibrations and protect against the ingress of creeping water

Applications

- Machine building
- Chemical industry
- Irrigation systems
- Ship manufacturing
- Railway industry
- Agricultural machines
- Building machines
- Engine manufacturing
- Pump and filter

Materials

W1	W2	W3	W4	W5
x			x*	x

*Only for the 30 mm band width

Material	Corrosion resistance in salt spray testing
W1	Min. 72 h
W5	Min. 400 h

NORMACLAMP® S/SP					
Band width b ₁	Minimum Ø in mm	Material thickness in mm			
		S		SP	
		W1	W5	W1	W5
5	5	0.2	–	0.2	–
7	6	0.3/0.4	0.4	0.4	0.4
9	9	0.4	0.4	0.6	0.4
12	12	0.5	0.5	0.7	0.5
15	20	0.6	0.6	0.8	0.6
20	25	1.0	0.8	(up to ø 47) 1.0 (from ø 48) 1.25	0.8
25	50**	1.25	1.0	1.25/1.5	1

Bolts

NORMACLAMP® S/SP			
Band width mm	Zy	Sz	Sk
5	M 2x12		
7	M 3x16		
9	M 4x22	M 4 x 20	
12		M 5x25	
15		M 6x30	
20		M 8x40	
25			M 10x45

Static torques

NORMACLAMP® S/SP		
Band width b ₁ mm	Static tightening torque Nm	Static test torque Nm
	max.	
7	0.5	0.6
9	1.2	1.5
12	1.5	1.8
15	4	4.8
20	12	14.5
25	30	36

Static torques according to DIN 3017-2

Technical data & Ordering information

NORMACLAMP® S															
Clamping diameter, mm	W1								W4	W5					
	Product No.								Product No.	Product No.					
	Band width								Band width	Band width					
	5 mm Zy	7 mm Zy	9 mm Zy	12 mm Sz	15 mm Sz	20 mm Sz	25 mm Sz	30 mm Sz	30 mm Sz	7 mm Zy	9 mm Zy	12 mm Sz	15 mm Sz	20 mm Sz	25 mm Sz
up to 9	0100 8980 ...														
up to 10		0110 8980 ...	0120 8980 ...							0110 0700 ...	0120 0700 ...				
from 15			0120 8980 ...	0130 0005 ...	0140 0000 ...						0120 0700 ...	0130 0705 ...	0140 0700 ...		
up to 20			0120 8980 ...	0130 0005 ...	0140 0000 ...						0120 0700 ...	0130 0705 ...	0140 0700 ...		
up to 28			0120 8980 ...	0130 0005 ...	0140 0000 ...						0120 0700 ...	0130 0705 ...	0140 0700 ...		
up to 30			0120 8980 ...		0140 0000 ...						0120 0700 ...		0140 0700 ...		
from 36			0120 8980 ...		0140 0000 ...	0150 0000 ...					0120 0700 ...		0140 0700 ...	0150 0700 ...	
up to 40			0120 8980 ...		0140 0000 ...	0150 0000 ...					0120 0700 ...		0140 0700 ...	0150 0700 ...	
up to 50			0120 8980 ...		0140 0000 ...	0150 0000 ...	0160 0000 ...				0120 0700 ...		0140 0700 ...	0150 0700 ...	0160 0700 ...
up to 60			0120 8980 ...		0140 0000 ...	0150 0000 ...	0160 0000 ...				0120 0700 ...		0140 0700 ...	0150 0700 ...	0160 0700 ...
up to 70			0120 8980 ...		0140 0000 ...	0150 0000 ...	0160 0000 ...				0120 0700 ...		0140 0700 ...	0150 0700 ...	0160 0700 ...
up to 75			0120 8980 ...		0140 0000 ...	0150 0000 ...	0160 0000 ...	0180 0000 ...	0180 0700 ...		0120 0700 ...		0140 0700 ...	0150 0700 ...	0160 0700 ...
up to 80					0140 0000 ...	0150 0000 ...	0160 0000 ...	0180 0000 ...	0180 0700 ...				0140 0700 ...	0150 0700 ...	0160 0700 ...
up to 90					0140 0000 ...	0150 0000 ...	0160 0000 ...	0180 0000 ...	0180 0700 ...				0140 0700 ...	0150 0700 ...	0160 0700 ...
up to 100					0140 0000 ...	0150 0000 ...	0160 0000 ...	0180 0000 ...	0180 0700 ...				0140 0700 ...	0150 0700 ...	0160 0700 ...
up to 110						0150 0000 ...	0160 0000 ...	0180 0000 ...	0180 0700 ...					0150 0700 ...	0160 0700 ...
up to 120						0150 0000 ...	0160 0000 ...	0180 0000 ...	0180 0700 ...					0150 0700 ...	0160 0700 ...
up to 130						0150 0000 ...		0180 0000 ...	0180 0700 ...					0150 0700 ...	
up to 140						0150 0000 ...		0180 0000 ...	0180 0700 ...					0150 0700 ...	
up to 150						0150 0000 ...		0180 0000 ...	0180 0700 ...					0150 0700 ...	
up to 160						0150 0000 ...		0180 0000 ...	0180 0700 ...					0150 0700 ...	
up to 170						0150 0000 ...		0180 0000 ...	0180 0700 ...					0150 0700 ...	
up to 180						0150 0000 ...		0180 0000 ...	0180 0700 ...					0150 0700 ...	
up to 190						0150 0000 ...		0180 0000 ...	0180 0700 ...					0150 0700 ...	
up to 200						0150 0000 ...		0180 0000 ...	0180 0700 ...					0150 0700 ...	

... = 0 without decimals in mm

SP Simple



NORMACLAMP® SP Simple is suitable for attaching rubber and plastic hoses as well as rubber sleeves to pipe ends or hose spigots. This clamp can be used for clamping containers, pipes and cables.

Materials

W1	W2	W3	W4	W5
x				x*

*On request

SP Double



NORMACLAMP® SP Double enables larger diameters to be clamped easily thanks to its multi-part design.

Materials

W1	W2	W3	W4	W5
x				x*

*On request

SPGU



NORMACLAMP® SPGU has a rubber profile that protects against vibrations and creeping water. It is also sound-absorbent and protects against contact corrosion.

Materials

W1	W2	W3	W4	W5
x				x*

*On request

Ordering information

NORMACLAMP® SP SPGU		
Material	SP	SPGU
W1	0181 0000 ...	0181 9000 ...
W4	0181 0700 ...	0181 9700 ...

... = Ø without decimals in mm



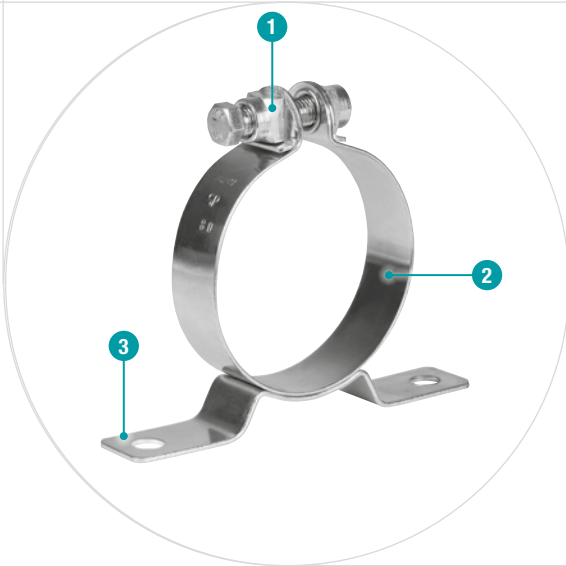

- 1 Powerful clamping brackets structure**
– secure grip
- 2 Robust band with rounded edges**
– prevents injuries and damage to hoses
- 3 Sturdy bracket**
– secure retention

Retaining clamps with brackets

NORMAFIX® HMK retaining clamps with brackets are used when high mechanical force is needed for retaining containers or pipes on ceilings and walls as well as in machine building and plant construction applications.

Standard design

This version features an “open” bracket, making it suitable for all applications in which relatively light structures are being retained and

which are subject to low mechanical loads. The standard version of the retaining clamps is available in one or two parts, and with band widths of 15, 20 and 25 mm.

These clamps can be fitted with a rubber profile for shock absorption purposes. The rubber profile simultaneously protects against the ingress of creeping water.

Advantages at a glance

- For high mechanical force
- Stable construction
- Chrome 6 free surface

Applications

- Machine building
- Chemical industry
- Irrigation systems
- Ship manufacturing
- Food and beverage industry
- Railway industry
- Agricultural machines
- Building machines
- Engine manufacturing
- Pump and filter
- Mining industry

Materials

W1	W2	W3	W4	W5
x			x	x

Rubber profiles

The rubber profiles are available in EPDM (type a) and silicone (type b) material versions.

B = band width of clamp
 b₁ = width in mm
 s₂ = material thickness in mm

All rubber profiles are installed at the factory, i.e., the clamps concerned are supplied ready for use.

When submitting requests/orders for NORMAFIX® HMK retaining clamps with brackets, please specify which rubber profile you require.

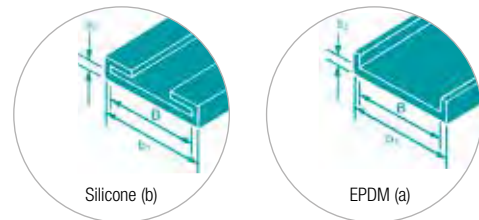

B	b ₁	s ₂
15	18.5	1.5
20	25	2.0
25	31	3.0
30	36	3.0

Technical data & Ordering information



NORMAFIX® HMK (standard design)												
Band width in mm	Designation	Min. ø in mm	Min. ø in in.	Bolts			d in mm	Rubber profile		s in mm		Part Group
				Sz	Sk	Dimensions		Silicone	EPDM	W1	W5	
15	HMK STANDARD 25/15	25	1	X		M6 x 30	6.5	X	X	0.8	0.6	1416
20	HMK STANDARD 30/20	30	1 3/16	X		M8 x 40	8.5	X	X	1.0-1.5	0.8	1516
25	HMK STANDARD 50/25	50	2		X	M10 x 45	11	X	X	1.5	1.0	1616

Ordering information

When submitting requests and orders, please specify the data in the following manner:

	1. Type	2. Parts	3. Diameter	4. Band width	5. Bolt	6. Material
Example	HMK STANDARD	1616	50/	25	SK	W1

Single-parts



Thanks to its structure the NORMACLAMP® HMK single-part is suitable for use with even high mechanical loads and for retaining extremely heavy pipes and connectors.

Advantages at a glance

- Stable construction
- Chrome 6 free surface
- EPDM Rubber profile

Materials

W1	W2	W3	W4	W5
x			x	

Two-parts



In this version, the ends of the brackets are folded back and spot-welded onto the band. Thanks to its structure the NORMACLAMP® HMK two-parts is suitable for use with even high mechanical loads and for retaining extremely heavy pipes and connectors.

Advantages at a glance

- Stable construction
- Chrome 6 free surface
- EPDM Rubber profile
- Two-parts clamp for bigger clamping range
- Suitable for larger hoses

Materials

W1	W2	W3	W4	W5
x			x	

K1

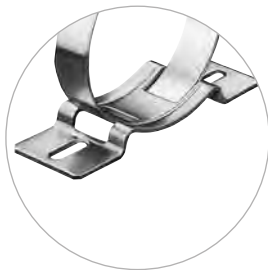

These are prefabricated brackets which you can use to transform NORMACLAMP® standard clamps (types GBS, HD, SP and TORRO) into retaining clamps with brackets in no time at all. Just open the standard clamp, guide the band through the bracket slot, and that's all there is to it.

Advantages at a glance

- Suitable for many clamp versions
- Easy to use

Materials

W1	W2	W3	W4	W5
x				

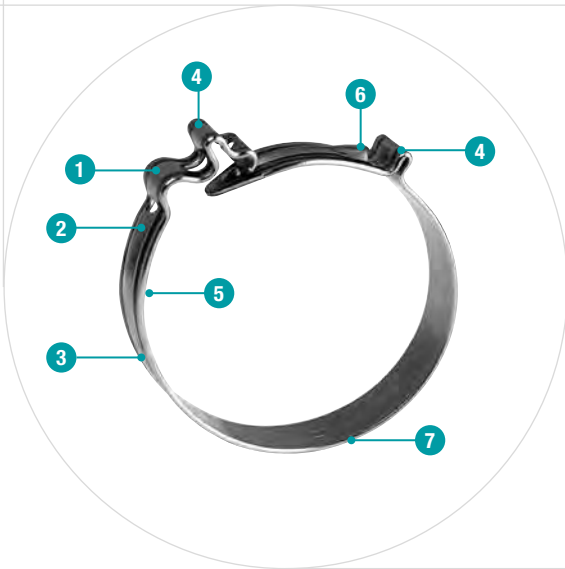

- 1 Self-adjusting diameter**
– compensation for tolerances at the outer diameter of the hose
- 2 Bead**
– secure band guidance
- 3 Color coding**
– a rapid way of visually distinguishing between nominal diameters
- 4 Protruding tool gripping points**
– easy and safe installation
- 5 Date of manufacture and machine number indicated**
- 6 Single lock-in point**
– installation indicator for easy visual checking
- 7 Band material with rounded outer edges**
– hose protection

One-piece hose clips

NORMACLAMP® COBRA products are bolt-free, one-piece hose clips. Their low overall height enables precise installation in even the tightest of spaces. NORMACLAMP® COBRA clamps are quick and easy to install.



Advantages at a glance

- Bolt-free hose clip in one piece
- Quick, easy and safe installation
- Maintenance-free fit

Applications

- Machine building
- White goods
- Chemical industry
- Irrigation systems
- Food and beverage industry
- Agricultural machines
- Engine manufacturing
- Pump and filter
- Suction lines
- Ventilation lines
- Washing machine hoses
- Pneumatic lines

Materials

W1	W2	W3	W4	W5
			x	

Material	Corrosion resistance in salt spray testing
W4	Min. 240 h

Selecting the right nominal diameter

- Push the hose onto the spigot and measure the outer diameter D_a .
- The applicable nominal diameter d_1 is then matched to this outer diameter D_a .

If required, we can send you an appropriate sample before you place your order.

If you have any additional, application-specific questions, we will be happy to advise you in more detail.

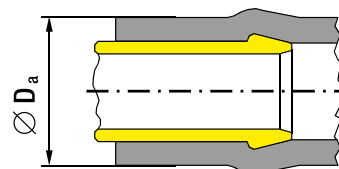

Technical data & Ordering information

NORMACLAMP® COBRA						
Width	Designation	Clamping ranges		Nominal diameter	W4 Product No.	Color
		in mm	in inches			
7	COBRA 7.5/7	8-9	5/16-3/8	7.5	0107 7000 075	White
	COBRA 8.0/7	8.5-9.5	5/16-3/8	8.0	0107 7000 008	Yellow
	COBRA 8.5/7	9-10	3/8-3/8	8.5	0107 7000 085	Green
	COBRA 9.0/7	9.5-10.5	3/8-3/8	9.0	0107 7000 009	Purple
	COBRA 9.5/7	10-11	3/8-7/16	9.5	0107 7000 095	Black
	COBRA 10.0/7	10.5-11.5	3/8-7/16	10	0107 7000 010	White
	COBRA 10.5/7	11-12	7/16-1/2	10.5	0107 7000 105	Yellow
	COBRA 11.0/7	11.5-12.5	7/16-1/2	11	0107 7000 011	Green
	COBRA 11.5/7	12-13	1/2-1/2	11.5	0107 7000 115	Purple
8	COBRA 12/8	12.5-14	1/2-9/16	12	0108 7006 012	Black
	COBRA 13/8	13.5-15	1/2-5/8	13	0108 7006 013	Yellow
	COBRA 14/8	14.5-16	9/16-5/8	14	0108 7006 014	Purple
	COBRA 15/8	15.5-17	5/8-11/16	15	0108 7006 015	White
	COBRA 16/8	16.5-18	5/8-3/4	16	0108 7006 016	Green
	COBRA 17/8	17.5-19	11/16-3/4	17	0108 7006 017	Black
	COBRA 18/8	18.5-20	3/4-13/16	18	0108 7006 018	Yellow
	COBRA 19/8	19.5-21	3/4-13/16	19	0108 7006 019	Purple
	COBRA 20/8	20.5-22	13/16-7/8	20	0108 7006 020	White
	COBRA 21/8	21.5-23	13/16-7/8	21	0108 7006 021	Green
	COBRA 22/8	22.5-24	7/8-15/16	22	0108 7006 022	Black
	COBRA 23/8	23.5-25	7/8-1	23	0108 7006 023	Yellow
	COBRA 24/8	24.5-26	15/16-1 1/16	24	0108 7006 024	Purple
	COBRA 25/8	25.5-27	1-1 1/16	25	0108 7006 025	White
	COBRA 26/8	26.5-28	1 1/16-1 1/8	26	0108 7006 026	Green
	COBRA 27/8	27.5-29	1 1/16-1 1/8	27	0108 7006 027	Black
	COBRA 28/8	28.5-30	1 1/8-1 3/16	28	0108 7006 028	Yellow
	COBRA 29/8	29.5-31	1 1/8-1 1/4	29	0108 7006 029	Purple
COBRA 30/8	30.5-32	1 3/16-1 1/4	30	0108 7006 030	White	



Refer to pages 181, 188 and 190.



- 1 Lot number stamped on**
– reliable traceability
- 2 NORMA® logo**
– a visible sign of quality
- 3 Organic/inorganic coating**
– optimum protection against corrosion
- 4 Nominal diameter stamped on**
– prevents mistakes
- 5 Special design**
– even distribution of clamping force and excellent roundness
- 6 Rounded band edges**
– optimum hose protection

Springband hose clamps in acc. with DIN 3021

Thanks to their dynamic spring properties, NORMACLAMP® FBS springband hose clamps are the perfect choice for hose spigot systems that are exposed to significant temperature fluctuations. Once installed, NORMACLAMP® FBS clamps ensure an automatic re-tensioning effect for an extended period. Even at low temperatures, this mechanism still enables sufficiently high levels of radial clamping force to be achieved, which in turn ensure excellent sealing reliability. With NORMACLAMP® FBS clamps, even hoses that are exposed to significant temperature fluctuations or have a tendency to “creep” can be joined securely.



A springband hose clamp with dynamic spring properties which ensure an automatic re-tensioning effect. It is particularly suitable for use with hose-spigot joints which are submitted to extreme temperature changes. Manual or pneumatic tools are used for professional installation.

Advantages at a glance

- One-piece, bolt-free hose clamp
- Even distribution of clamping force
- Optimum roundness
- Temperature resistance from –40 °C to 200 °C
- Clear traceability due to batch numbering

Applications

- Machine building
- White goods
- Agricultural machines
- Engine manufacturing
- Cooling and heating water circuits
- Fuel vent system
- Air ducts
- Water and brine outlet lines

Materials

Material	Zinc/aluminum coating	Organic coating
C 75 S	Base coat	Top coat

Corrosion resistance in salt spray testing
480 h and up

Short description

- Dynamic clamp
- Band material C 75 S
- Coating containing zinc; no chromium(VI)
- Nominal diameter of 13 mm to 80 mm in various gradations



- At high temperatures**
- Hose diameter increases
 - FBS adapts to internal pressure



- At low temperatures**
- Hose diameter decreases
 - FBS re-tensions
 - Clamping force is retained and clamp provides perfect seal

Determine clamp

To determine which clamp is right for you, follow these steps:

1. Push the hose onto the spigot and measure $D_{min.}$ and $D_{max.}$
2. Based on the $D_{min.}$ value, determine the nominal diameter (D_n) of the clamp in question. $D_n = D_{min.}$
3. Compare the $D_{max.}$ value with the minimum diameter ($D_{0 min.}$) specified for the open clamp and select the clamp that is appropriate.
 $D_{0 min.} \geq D_{max.}$

If required, we can send you an appropriate sample before you place your order. If you have any additional, application-specific questions, we will be happy to advise you in more detail.

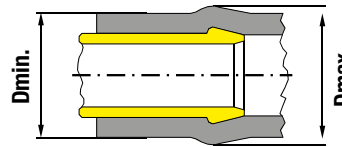
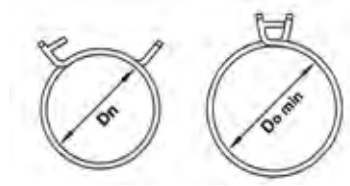

Technical data & Ordering information

NORMACLAMP® FBS STANDARD							
Width	Designation	D _n mm	D _n in inches	D _{0 m} in mm	D _{0 min} in inches	Material C 75 S Product No.	
						Black	Silver
12	FBS 13/12	13	1/2	14.5	9/16	0112 8024 013	0112 8074 013
	FBS 14/12	14	9/16	15.8	5/8	0112 8024 014	0112 8074 014
	FBS 15/12	15	9/16	16.8	11/16	0112 8024 015	0112 8074 015
	FBS 16/12	16	5/8	17.5	11/16	0112 8024 016	0112 8074 016
	FBS 17/12	17	11/16	18.5	3/4	0112 8024 017	0112 8074 017
	FBS 18/12	18	11/16	19	3/4	0112 8024 018	0112 8074 018
	FBS 19/12	19	3/4	21	13/16	0112 8024 019	0112 8074 019
	FBS 20/12	20	13/16	21.6	7/8	0112 8024 020	0112 8074 020
	FBS 21/12	21	13/16	22.5	7/8	0112 8024 021	0112 8074 021
	FBS 22/12	22	7/8	24.5	15/16	0112 8024 022	0112 8074 022
	FBS 23/12	23	15/16	24.7	1	0112 8024 023	0112 8074 023
	FBS 24/12	24	15/16	26	1	0112 8024 024	0112 8074 024
	FBS 25/12	25	1	27	1 1/16	0112 8024 025	0112 8074 025
	FBS 26/12	26	1	28	1 1/8	0112 8024 026	0112 8074 026
	FBS 27/12	27	1 1/16	29	1 1/8	0112 8024 027	0112 8074 027
	FBS 28/12	28	1 1/8	30.5	1 3/16	0112 8024 028	0112 8074 028
	FBS 29/12	29	1 1/8	31.5	1 1/4	0112 8024 029	0112 8074 029
	FBS 30/12	30	1 3/16	32.5	1 1/4	0112 8024 030	0112 8074 030
	FBS 32/12	32	1 1/4	34.5	1 3/8	0112 8024 032	0112 8074 032
	FBS 35/12	35	1 3/8	38	1 1/2	0112 8024 035	0112 8074 035
	FBS 36/12	36	1 7/16	39	1 9/16	0112 8024 036	0112 8074 036
	FBS 38/12	38	1 1/2	41.5	1 5/8	0112 8024 038	0112 8074 038
	FBS 40/12	40	1 9/16	42.5	1 11/16	0112 8024 040	0112 8074 040
	FBS 42/12	42	1 5/8	44.5	1 3/4	0112 8024 042	0112 8074 042
	FBS 44/12	44	1 3/4	46.5	1 13/16	0112 8024 044	0112 8074 044
	FBS 46/12	46	1 13/16	49	1 15/16	0112 8024 046	0112 8074 046
	FBS 47/12	47	1 7/8	50	2	0112 8024 047	0112 8074 047
	FBS 50/12	50	2	53	2 1/16	0112 8024 050	0112 8074 050
	FBS 55/12	55	2 3/16	58	2 1/4	0112 8024 055	0112 8074 055
	FBS 60/12	60	2 3/8	63	2 1/2	0112 8024 060	0112 8074 060

Special diameters available on request



Refer to pages 188 and 190.

R



The NORMACLAMP® FBS R was designed with the aim of achieving the smallest overall height that was technically possible so that it could be used in difficult installation conditions.

Advantages at a glance

- Space-saving clamp

Materials

- C75S

NORMACLAMP® FBS R							
Width	Designation	D _n mm	D _n in inches	D _{0 min} mm	D _{0 min} in inches	Material C 75 S Product No.	
						Black	Silver
12	FBS R 14/12	14	9/16	15.8	5/8	0112 8025 014	0112 8075 014
	FBS R 16/12	16	5/8	17.5	11/16	0112 8025 016	0112 8075 016
	FBS R 19/12	19	3/4	21	13/16	0112 8025 019	0112 8075 019
	FBS R 23/12	23	15/16	24.7	1	0112 8025 023	0112 8075 023
	FBS R 27/12	27	1 1/16	29	1 1/8	0112 8025 027	0112 8075 027
	FBS R 40/12	40	1 9/16	42.5	1 11/16	0112 8025 040	0112 8075 040

Special diameters available on request



Refer to pages 188 and 190.

C



A pre-opened clamp that is prepositioned on the hose. The retaining mechanism for this version is part of the band and is integrated into the clamp.

Advantages at a glance

- Pre-assembled clamp
- Ready to use

Materials

- C75S

NORMACLAMP® FBS C							
Width	Designation	D _n mm	D _n in inches	D _{0 min} mm	D _{0 min} in inches	Material C 75 S Product No.	
						Black	Silver
12	FBS C 17/12	17	11/16	18.5	3/4	0112 8502 017	
	FBS C 21/12	21	13/16	22.5	7/8	0112 8502 021	
	FBS C 23/12	23	15/16	24.7	1	0112 8502 023	
	FBS C 25/12	25	1	27	1 1/16	0112 8502 025	
	FBS C 27/12	27	1 1/16	29	1 1/8	0112 8502 027	
	FBS C 29/12	29	1 1/8	31.5	1 1/4	0112 8502 029	
	FBS C 32/12	32	1 1/4	34.5	1 3/8	0112 8502 032	
	FBS C 36/12	36	1 7/16	39	1 9/16	0112 8502 036	
	FBS C 40/12	40	1 9/16	42.5	1 11/16	0112 8502 040	
	FBS C 44/12	44	1 3/4	46.5	1 13/16	0112 8502 044	



Refer to page 188.

HC



A pre-opened version that is secured by a plastic clip. Once the clamp has been pushed onto the hose, this clip can be released easily by hand.

Advantages at a glance

- Easy to assemble

Materials

- C75S

NORMACLAMP® FBS HC

Width	Designation	D _n mm	D _n in inches	D _{0 min} mm	D _{0 min} in inches	Material C 75 S Product No.	
						Black	Silver
12	FBS HC 13/12	13	1/2	14.5	9/16	0112 8302 013	0112 8352 013
	FBS HC 14/12	14	9/16	15.8	5/8	0112 8302 014	0112 8352 014
	FBS HC 15/12	15	9/16	16.8	11/16	0112 8302 015	0112 8352 015
	FBS HC 16/12	16	5/8	17.5	11/16	0112 8302 016	0112 8352 016
	FBS HC 17/12	17	11/16	18.5	3/4	0112 8302 017	0112 8352 017
	FBS HC 18/12	18	11/16	19	3/4	0112 8302 018	0112 8352 018
	FBS HC 19/12	19	3/4	21	13/16	0112 8302 019	0112 8352 019
	FBS HC 20/12	20	13/16	21.6	7/8	0112 8302 020	0112 8352 020
	FBS HC 21/12	21	13/16	22.5	7/8	0112 8302 021	0112 8352 021
	FBS HC 22/12	22	7/8	24.5	15/16	0112 8302 022	0112 8352 022
	FBS HC 23/12	23	15/16	24.7	1	0112 8302 023	0112 8352 023
	FBS HC 24/12	24	15/16	26	1	0112 8302 024	0112 8352 024
	FBS HC 25/12	25	1	27	1 1/16	0112 8302 025	0112 8352 025
	FBS HC 26/12	26	1	28	1 1/8	0112 8302 026	0112 8352 026
	FBS HC 27/12	27	1 1/16	29	1 1/8	0112 8302 027	0112 8352 027
	FBS HC 28/12	28	1 1/8	30.5	1 3/16	0112 8302 028	0112 8352 028
	FBS HC 29/12	29	1 1/8	31.5	1 1/4	0112 8302 029	0112 8352 029
	FBS HC 30/12	30	1 3/16	32.5	1 1/4	0112 8302 030	0112 8352 030
	FBS HC 32/12	32	1 1/4	34.5	1 3/8	0112 8302 032	0112 8352 032
	FBS HC 35/12	35	1 3/8	38	1 1/2	0112 8302 035	0112 8352 035
	FBS HC 36/12	36	1 7/16	39	1 9/16	0112 8302 036	0112 8352 036
	FBS HC 38/12	38	1 1/2	41.5	1 5/8	0112 8302 038	0112 8352 038
	FBS HC 40/12	40	1 9/16	42.5	1 11/16	0112 8302 040	0112 8352 040
	FBS HC 42/12	42	1 5/8	44.5	1 3/4	0112 8302 042	0112 8352 042
	FBS HC 44/12	44	1 3/4	46.5	1 13/16	0112 8302 044	0112 8352 044
	FBS HC 46/12	46	1 13/16	49	1 15/16	0112 8302 046	0112 8352 046
	FBS HC 47/12	47	1 7/8	50	2	0112 8302 047	0112 8352 047
	FBS HC 50/12	50	2	53	2 1/16	0112 8302 050	0112 8352 050
	FBS HC 55/12	55	2 3/16	58	2 1/4	0112 8302 055	0112 8352 055
	FBS HC 60/12	60	2 3/8	63	2 1/2	0112 8302 060	0112 8352 060

Special diameters available on request

MC



A pre-opened (and, if required, prepositioned) clamp that is secured with a small metal clip. The retaining clip for this version is removed by using pliers.

Advantages at a glance

- Secured clamp

Materials

- C75S

NORMACLAMP® FBS MC							
Width	Designation	D _n mm	D _n in inches	D _{0 min} mm	D _{0 min} in inches	Material C 75 S Product No.	
						Black	Silver
12	FBS MC 13/12	13	1/2	14.5	9/16	0112 8019 013	0112 8475 013
	FBS MC 14/12	14	9/16	15.8	5/8	0112 8019 014	0112 8475 014
	FBS MC 15/12	15	9/16	16.8	11/16	0112 8019 015	0112 8475 015
	FBS MC 16/12	16	5/8	17.5	11/16	0112 8019 016	0112 8475 016
	FBS MC 17/12	17	11/16	18.5	3/4	0112 8019 017	0112 8475 017
	FBS MC 18/12	18	11/16	19	3/4	0112 8019 018	0112 8475 018
	FBS MC 19/12	19	3/4	21	13/16	0112 8019 019	0112 8475 019
	FBS MC 20/12	20	13/16	21.6	7/8	0112 8019 020	0112 8475 020
	FBS MC 21/12	21	13/16	22.5	7/8	0112 8019 021	0112 8475 021
	FBS MC 22/12	22	7/8	24.5	15/16	0112 8019 022	0112 8475 022
	FBS MC 23/12	23	15/16	24.7	1	0112 8019 023	0112 8475 023
	FBS MC 24/12	24	15/16	26	1	0112 8019 024	0112 8475 024
	FBS MC 25/12	25	1	27	1 1/16	0112 8019 025	0112 8475 025
	FBS MC 26/12	26	1	28	1 1/8	0112 8019 026	0112 8475 026
	FBS MC 27/12	27	1 1/16	29	1 1/8	0112 8019 027	0112 8475 027
	FBS MC 28/12	28	1 1/8	30.5	1 3/16	0112 8019 028	0112 8475 028
	FBS MC 29/12	29	1 1/8	31.5	1 1/4	0112 8019 029	0112 8475 029
	FBS MC 30/12	30	1 3/16	32.5	1 1/4	0112 8019 030	0112 8475 030
	FBS MC 32/12	32	1 1/4	34.5	1 3/8	0112 8019 032	0112 8475 032
	FBS MC 35/12	35	1 3/8	38	1 1/2	0112 8019 035	0112 8475 035
	FBS MC 36/12	36	1 7/16	39	1 9/16	0112 8019 036	0112 8475 036
	FBS MC 38/12	38	1 1/2	41.5	1 5/8	0112 8019 038	0112 8475 038
	FBS MC 40/12	40	1 9/16	42.5	1 11/16	0112 8019 040	0112 8475 040
	FBS MC 42/12	42	1 5/8	44.5	1 3/4	0112 8019 042	0112 8475 042
	FBS MC 44/12	44	1 3/4	46.5	1 13/16	0112 8019 044	0112 8475 044
	FBS MC 46/12	46	1 13/16	49	1 15/16	0112 8019 046	0112 8475 046
	FBS MC 47/12	47	1 7/8	50	2	0112 8019 047	0112 8475 047
	FBS MC 50/12	50	2	53	2 1/16	0112 8019 050	0112 8475 050
	FBS MC 55/12	55	2 3/16	58	2 1/4	0112 8019 055	0112 8475 055
	FBS MC 60/12	60	2 3/8	63	2 1/2	0112 8019 060	0112 8475 060

Special diameters available on request



- 1 Ear**
– one tightening side
- 2 Smooth inner band**
- 3 Round edges to prevent damages**

One part clamp for low and medium pressure.

The NORMACLAMP® Earclip single has no screw. The assembly is fast, simple and safe thanks to the pinching of the ear.

Advantages at a glance

- Cost effective, and simple alternative to worm drive hose clips
- Fast and easy to install
- Ideal in narrow spaces
- Suitable for definitive fixation of connecting pipes
- To be assembled with simple ear clip pliers

Applications

- For hoses that convey compressed air or fluid
- Original equipment manufacturing
- Maintenance repair and overhaul

Materials

W1	W2	W3	W4	W5
x			x	

Technical data & Ordering information

NORMACLAMP® EARCLIP SINGLE					
Width	Description	Clamping ranges		W1 Product No.	W4 Product No.
		in mm	in inches		
6	EARCLIP SINGLE 8 - 10/6	8 - 10	5/16-3/8	0110 7010 010	0110 7011 010
6.5	EARCLIP SINGLE 9 - 11/6.5	9 - 11	3/8-7/16	0110 7010 011	0110 7011 011
	EARCLIP SINGLE 10 - 12/6.5	10 - 12	3/8-1/2	0110 7010 012	0110 7011 012
	EARCLIP SINGLE 11 - 13/6.5	11 - 13	7/16-1/2	0110 7010 013	0110 7011 013
7	EARCLIP SINGLE 12 - 14/7	12 - 14	1/2-9/16	0110 7010 014	0110 7011 014
	EARCLIP SINGLE 13 - 15/7	13 - 15	1/2-9/16		0110 7011 015
	EARCLIP SINGLE 14 - 16/7	14 - 16	9/16-5/8	0110 7010 016	0110 7011 016
	EARCLIP SINGLE 16 - 18/7	16 - 18	5/8-11/16	0110 7010 018	0110 7011 018



Refer to page 190.



- 1 Ear**
– one tightening side
- 2 Smooth inner band, and inner liner for security and roundness**
- 3 Round edges to prevent damages**
- 4 Inner liner**
– effective and powerful all-round seal

One part clamp for low and medium pressure.

The NORMACLAMP® Earclip safe has no screw. The assembly is fast, simple and safe thanks to the pinching of the ear. The inner insert allows a better distribution of the clamping force.

Advantages at a glance

- Cost effective, and simple alternative to worm drive hose clips
- Fast and easy to install
- Ideal in narrow spaces
- Suitable for definitive fixation of connecting pipes
- To be assembled with simple ear clip pliers
- Inner liner for security and better distribution of the clamping force

Applications

- For hoses that convey compressed air or fluid
- Original equipment manufacturing
- Maintenance repair and overhaul

Materials

W1	W2	W3	W4	W5
x			x	

Technical data & Ordering information

NORMACLAMP® EARCLIP SAFE					
Width	Description	Clamping ranges		W1 Product No.	W4 Product No.
		in mm	in inches		
6	EARCLIP SAFE 7.5-8.5/6	7.5-8.5	5/16-5/16	0110 7014 008	0110 7015 008
	EARCLIP SAFE 8-9.5/6	8-9.5	5/16-3/8	0110 7014 009	0110 7015 009
6.5	EARCLIP SAFE 9-10.5/6.5	9-10.5	3/8-7/16	0110 7014 010	0110 7015 010
	EARCLIP SAFE 10-11.5/6.5	10-11.5	3/8-7/16	0110 7014 011	0110 7015 011
	EARCLIP SAFE 10.5-12.5/6.5	10.5-12.5	7/16-1/2	0110 7014 012	0110 7015 012
7	EARCLIP SAFE 11.5-13.3/7	11.5-13.3	7/16-1/2	0110 7014 013	0110 7015 013
	EARCLIP SAFE 12.5-14.5/7	12.5-14.5	1/2-9/16		0110 7015 014
	EARCLIP SAFE 13-15.3/7	13-15.3	1/2-5/8	0110 7014 015	0110 7015 015
	EARCLIP SAFE 14-16/7	14-16	9/16-1/4		0110 7015 016
	EARCLIP SAFE 15-17.3/7	15-17.3	9/16-11/16	0110 7014 017	0110 7015 017
7.5	EARCLIP SAFE 16-18.3/7.5	16-18.3	1/4-3/4		0110 7015 018
	EARCLIP SAFE 17-19.3/7.5	17-19.3	11-16-3/4		0110 7015 019



Refer to page 190.



- 1 Ear**
– two ears for higher clamping range
- 2 Smooth inner band**
- 3 Round edges to prevent damages**

One part clamp for low and medium pressure.

The NORMACLAMP® Earclip double has no screw. The assembly is fast, simple and safe thanks to the pinching of the ears. The two ears enable a better and more constant sealing force. The tightening force is improved.

Advantages at a glance

- Cost effective, and simple alternative to worm drive hose clips
- Fast and easy to install
- Ideal in narrow spaces
- Suitable for definitive fixation of connecting pipes
- To be assembled with simple ear clip pliers
- Extended clamping range

Applications

- For hoses that convey compressed air or fluid
- Original equipment manufacturing
- Maintenance repair and overhaul

Materials

W1	W2	W3	W4	W5
x			x	

Technical data & Ordering information

NORMACLAMP® EARCLIP DOUBLE					
Width	Designation	Clamping ranges		W1 Product No.	W4 Product No.
		in mm	in inches		
5.5	EARCLIP DOUBLE 3-5/5.5	3-5	1/8-3/16		0110 7013 005
6	EARCLIP DOUBLE 5-7/6	5-7	3/16-1/4	0110 7012 007	0110 7013 007
	EARCLIP DOUBLE 7-9/6	7-9	1/4-3/8	0110 7012 009	0110 7013 009
6.5	EARCLIP DOUBLE 9-11/6.5	9-11	3/8-7/16	0110 7012 011	0110 7013 011
	EARCLIP DOUBLE 10-12/6.5	10-12	3/8-1/2	0110 7012 012	0110 7013 012
	EARCLIP DOUBLE 11-13/6.5	11-13	7/16-1/2	0110 7012 013	0110 7013 013
7	EARCLIP DOUBLE 13-15/7	13-15	1/2-9/16	0110 7012 015	0110 7013 015
	EARCLIP DOUBLE 14-17/7	14-17	9/16-11/16	0110 7012 017	0110 7013 017
7.5	EARCLIP DOUBLE 15-18/7.5	15-18	9/16-11/16	0110 7012 018	0110 7013 018
	EARCLIP DOUBLE 17-20/7.5	17-20	11/16-13/16	0110 7012 020	0110 7013 020
8	EARCLIP DOUBLE 18-21/8	18-21	11/16-13/16	0110 7012 021	0110 7013 021
	EARCLIP DOUBLE 20-23/8	20-23	13/16-15/16	0110 7012 023	0110 7013 023
9	EARCLIP DOUBLE 22-25/9	22-25	7/8-1	0110 7012 025	0110 7013 025
10	EARCLIP DOUBLE 23-27/10	23-27	15/16-1 11/16	0110 7012 027	
	EARCLIP DOUBLE 25-28/10	25-28	1-1 1/8	0110 7012 028	
	EARCLIP DOUBLE 28-31/10	28-31	1 1/8-1 1/4	0110 7012 031	
	EARCLIP DOUBLE 31-34/10	31-34	1 1/4-1 5/16	0110 7012 034	
	EARCLIP DOUBLE 34-37/10	34-37	1 5/16-1 7/16	0110 7012 037	
	EARCLIP DOUBLE 37-40/10	37-40	1 7/16-1 9/16	0110 7012 040	
	EARCLIP DOUBLE 40-43/10	40-43	1 9/16-1 11/16	0110 7012 043	
	EARCLIP DOUBLE 43-46/10	43-46	1 11/16-1 13/16	0110 7012 046	



Refer to page 190.



NORMACONNECT® – Pipe Connections

The perfect method of connecting pipes

When it comes to pipe connections, the industry and OEMs rely on NORMACONNECT® – the reliable solution that can be used with all kinds of different requirements, pipe materials and outer pipe diameters.

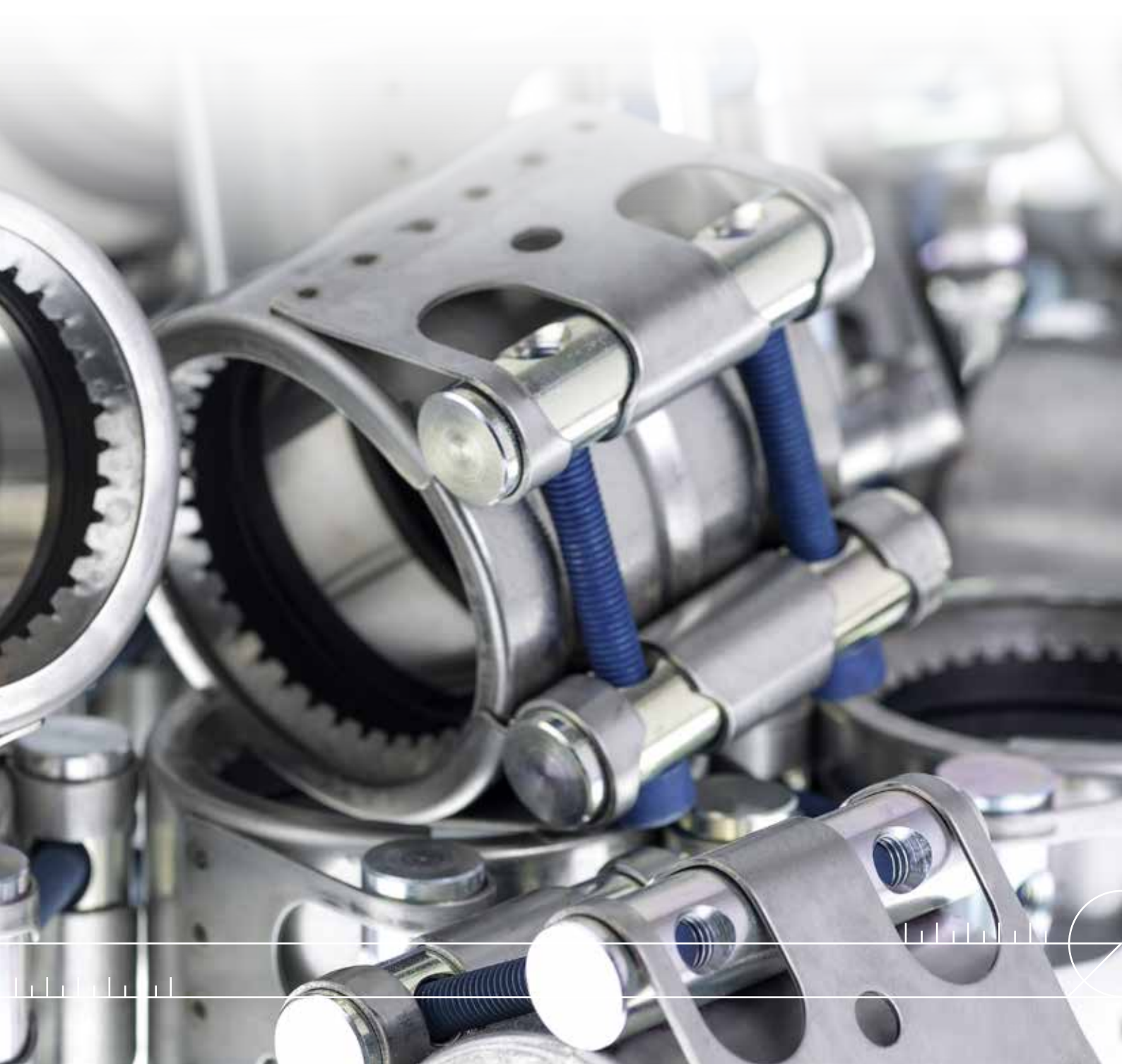

Our solution for connecting – FGR

NORMACONNECT®



FGR pipe couplings are a compact, economical and reliable means for connecting plain-ended pipes. They are suitable to join plastic and metal pipes and especially pipes made from stainless steel. They can be used in mechanical engineering and construction, shipbuilding, civil engineering and in hydro technology.

Supply pipes as well as exhaust pipes for solid, liquid or gaseous media can be joined easily and safely in a very short period of time even in narrow spaces. Thanks to the wide range of various types and sizes they are suitable for use both in standard and specialized applications.

Product benefits

FGR pipe couplings are an economical alternative to conventional pipe joining techniques for both plastic and metal pipes. All plain-ended pipes can be joined easily by hand. The ready-to-fit coupling is pushed over the pipe ends and then aligned and rotated to any fitting position. Tightening the two bolts alternately with a torque wrench is all it takes to make a safe fitting.

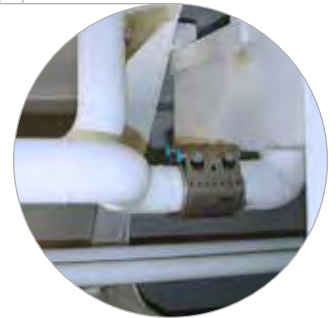

Range of applications

FGR pipe coupling is a reliable connection for thick- and thin-walled pipes which conforms to the latest DIN Standard 86128. Feed and return lines for liquids, gases and solids (for mechanical engineering and construction, civil

engineering, shipbuilding, pipeline construction, power stations, mining, filters, water technology, etc.) are joined quickly, easily and safely using FGR pipe couplings.



- No welding
- No necessity for prior pipe alignment or treatment of pipe ends
- Up to 80% time saving



- Pipe gaps up to 35 mm possible
- Axial movements up to 7.5 mm
- Misalignment up to 3 mm



- 70% less weight



- Angular deflection up to 4° in total

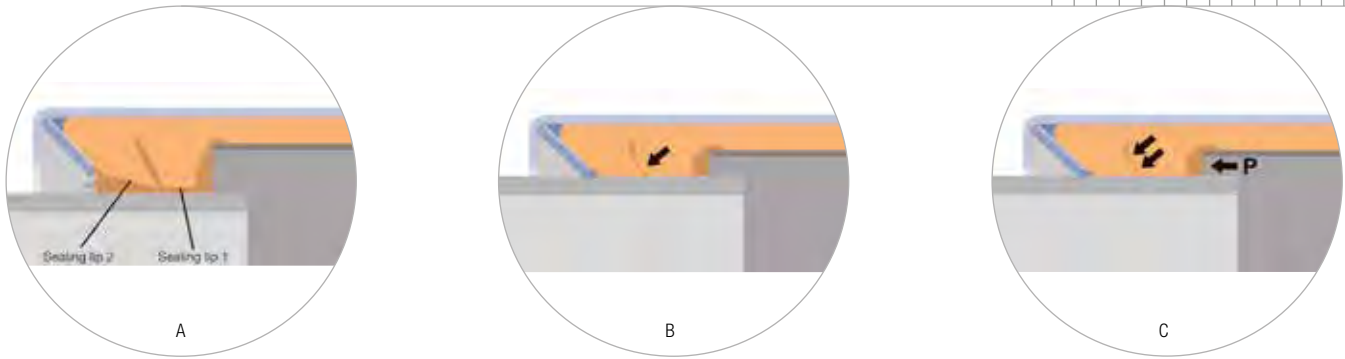

1. Double-lip sealing system

The patented double-lip sealing system (Fig. A) of the FGR pipe couplings offers double safety. It provides maximum sealability at both low and high operating pressures.

When the bolts of the coupling are tightened, sealing lip 1 is pressed onto sealing lip 2, thus providing a highly reliable seal even under conditions of low pressure, vacuum or extreme loads acting on the joint (Fig. B).

The special sealing lip design means that when the internal pressure (P) increases, the sealing lips are pressed more firmly onto the pipe surface ensuring an even stronger seal (Fig. C).

2. Standard strip insert

All FGR pipe couplings are factory equipped with the standard strip insert (2). The strip insert protects the sealing sleeve from increased mechanical and chemical loads. It also prevents the sealing sleeve from moisture expansion and allows larger gaps between the pipe ends to be connected.

Furthermore, it allows larger angular deflections and misalignment. With the strip insert the couplings can also be used for both vacuum and high pressure applications without any problems. The strip inserts are made from plastic material or stainless steel.

3. Heavy duty lock bars

For FGR pipe couplings we use lock bars (3) with a larger diameter. Thus the rigidity of the coupling is increased and the engagement of the threaded end of the locking bolts is considerably improved.

4. Anchoring ring with conically stamped teeth



















The anchoring ring (4) with conically stamped teeth indents into the pipe surface and provides safe and strong axial restraint. Owing to the special design the coupling is able to withstand even high vibration loads.

5. Protection ring

The protection ring protects the sealing sleeve from UV rays, fire, etc., and increases the flexural strength of the coupling.



Approvals

SHIPBUILDING		FLEX / FLEX E / RFP		GRIP / GRIP E / Grip E-FP / RFP		CombiGrip / CombiGrip E	PlastGrip / PlastGrip E	Rep E
		26.9 - 168.3 mm	> 180 mm	26.9 - 168.3 mm	> 180 mm			
ABS		•	•	•	•	•	•	
Bureau Veritas		•	•	•	•	•	•	
DNV		•	•	•	•			
GL		•	•	•	•			
LRS		• ¹	• ¹	• ¹	• ¹	•	•	
CLASS NK		•	•	•	•	•	•	
RINA		•	•	•	•			
RMRS		•	•	•	•	•	•	
PRS		• ¹	• ¹	• ¹	• ¹			
KRS		•	•	•	•	•	•	
WATER SUPPLY & TREATMENT								
KTW		•		•		•	•	•
DVGW							• ²	
SVGW							• ²	
NSF		EPDM		EPDM		EPDM	EPDM	
DGS		EPDM	EPDM	EPDM	EPDM	EPDM	EPDM	EPDM
GAS								
DVGW / GWI				•			•	
SVGW							•	
SPECIAL APPROVALS								
VdS				• ⁴				
DiBT / TÜV south. Germany				•				
BWB				•	3			
FDA		•		•		•	•	

¹ No approvals for RFP

² From 40.0 mm up to 160 mm

³ German approval for the German marine

⁴ For the following sizes: 33.7 - 42.4 - 48.3 - 60.3 - 76.1 - 88.9 - 114.3 - 139.7

Coupling types and suitable applications

Pipes to be joined	Size (mm)	Flex	Flex E	Flex 3	REP E from 35 mm
Metal + Metal	26.9 to 168.3	70 to 32 bar	70 to 32 bar	-	60 to 32 bar
	180.0 to 1219.2	50 to 7 bar	30 to 4 bar	-	30 to 4 bar
	326.0 to 2032.0	-	-	16.5 to 1.5 bar	-
Plastic + Plastic	26.9 to 168.3	16 bar	16 bar	-	16 bar
	180.0 to 1219.2	16 to 4 bar	16 to 4 bar	-	16 to 4 bar
Metal + Plastic	26.9 to 168.3	16 bar	16 bar	-	-
	180.0 to 1219.2	16 to 7 bar	16 to 7 bar	-	-

Pipes to be joined	Size (mm)	Grip	Grip E	Combi-Grip E	Combi-Grip	Plast-Grip E	Plast-Grip	Grip E-FP
Metal + Metal	26.9 to 168.3	70 to 32 bar	70 to 32 bar	-	-	-	-	60 to 32 bar
	180.0 to 419.0	-	20 to 2 bar	-	-	-	-	20 to 65 bar
	180.0 to 711.2	32 to 2.5 bar	-	-	-	-	-	-
Plastic + Plastic	40.0 to 168.3	-	-	-	-	16 bar	-	-
	200.0 to 406.4	-	-	-	-	-	16 to 6 bar	-
Metal + Plastic	38/40 to 160/168.3	16 bar	16 bar	16 bar	-	-	-	-
	200.0/204.0 to 406.0 /406.4	-	-	-	16 to 6 bar	-	-	-

Sealing sleeves

Areas of application & temperature resistance

Material of seal	EPDM	NBR
Temperature range	-30 °C up to +125 °C OD 26.9 up to 168.3 mm -20 °C up to +80 °C OD > 180 mm	-20 °C up to +80 °C
Media	Drinking water Alcohols Compressed air Solids	Water Oils Gases (combustible) Fuels Hydrocarbon solutions

FGR Materials

Components and materials in accordance with AISI/BS. FGR pipe couplings are available in the materials W2, W4 and W5.

NORMACONNECT®

W2				
No.	Component	Flex/Flex E	Grip/Grip E	Plast Grip/ Plast Grip E
1	Housing with bridge	304/304 S31	304/304 S31	304/304 S31
2	Sealing sleeve	EPDM/NBR	EPDM/NBR	EPDM/NBR
3	Strip insert ¹⁾	316Ti/320 S31/PA-GR	316Ti/320 S31/PA-GR	316Ti/320 S31/PA-GR
4 A	Anchoring ring for metal pipes ²⁾	–	301/301 S21	–
4 A	Anchoring ring for plastic pipes ²⁾	–	–	PA-GF-NS ³⁾
4 B	Protection ring	316Ti/320 S31	–	–
5 + 6	Solid locking trunnions	AISI 1213	AISI 1213	AISI 1213
5 + 6	Hollow locking trunnions	AISI 1518	AISI 1518	AISI 1518
7	Locking bolts	10.9	10.9	10.9
8	Washer	A4-80/316	A4-80/316	A4-80/316

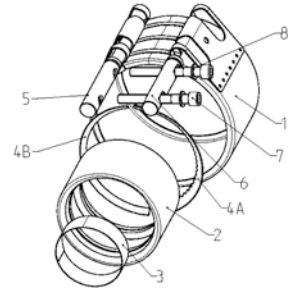

W4				
No.	Component	Flex/Flex E	Grip/Grip E	Plast Grip/ Plast Grip E
1	Housing with bridge	304/304 S31	304/304 S31	304/304 S31
2	Sealing sleeve	EPDM/NBR	EPDM/NBR	EPDM/NBR
3	Strip insert ¹⁾	316Ti/320 S31/PA-GR	316Ti/320 S31/PA-GR	316Ti/320 S31/PA-GR
4 A	Anchoring ring for metal pipes ²⁾	–	301/301 S21	–
4 A	Anchoring ring for plastic pipes ²⁾	–	–	PA-GF-NS ³⁾
4 B	Protection ring	316Ti/320 S31	316Ti/320 S31	–
5 + 6	Solid locking trunnions	316L	316L	1.4404
5 + 6	Hollow locking trunnions	316Ti/320 S31	316Ti/320 S31	1.4571
7	Locking bolts	A4-80/316	A4-80/316	A4-80
8	Washer	A4-80/316	A4-80/316	A4-80

¹⁾ PA-GF plastic strip inserts are only for pipe couplings used in shipbuilding applications.

²⁾ COMBI GRIP couplings are equipped with two different anchoring rings (1 x for the metal end, 1 x for the plastic end).

³⁾ PA-GF: PA reinforced with fiber glass; NS: new silver.

W5						
No.	Component	Flex/Flex E	Grip/Grip E	Combi Grip/ Combi Grip E	Plast Grip/ Plast Grip E	Rep E
1	Housing	316Ti/320 S31	316Ti/320 S31	316Ti/320 S31	316Ti/320 S31	316Ti/320 S31
2	Sealing sleeve	EPDM/NBR	EPDM/NBR	EPDM/NBR	EPDM/NBR	EPDM/NBR
3	Strip insert ¹⁾	316Ti/320 S31/PA-GR	316Ti/320 S31/PA-GR	316Ti/320 S31/PA-GR	316Ti/320 S31/PA-GR	316Ti/320 S31/PA-GR
4 A	Anchoring ring for metal pipes ²⁾	–	301/301 S21	301/301 S21 301/301 S21	–	–
4 A	Anchoring ring for plastic pipes ²⁾	–	–	PA-GF-NS ³⁾	PA-GF-NS ³⁾	–
4 B	Protection ring	316Ti/320 S31	–	–	–	–
5 + 6	Solid locking trunnions	316L	316L	316L	316L	316L
5 + 6	Hollow locking trunnions	316Ti/320 S31	316Ti/320 S31	316Ti/320 S31	316Ti/320 S31	316Ti/320 S31
7	Locking bolts	A4-80/316	A4-80/316	A4-80/316	A4-80/316	A4-80/316
8	Washer	A4-80/316	A4-80/316	A4-80/316	A4-80/316	A4-80/316

¹⁾ PA-GF plastic strip inserts are only for pipe couplings used in shipbuilding applications.

²⁾ COMBI GRIP couplings are equipped with two different anchoring rings (1 x for the metal end, 1 x for the plastic end).

³⁾ PA-GF: PA reinforced with fiber glass; NS: new silver.



- 1 Double-lip sealing system
- 2 Standard strip insert
- 3 Heavy duty lock bars
- 4 Protection ring

The protective pipe coupling

NORMACONNECT® FLEX /FLEX E pipe couplings are used for connecting restrained pipes, metal pipes, stainless pipes, as well as concrete and plastic pipes. With NORMACONNECT® FLEX/FLEX E pipe couplings, sealing reliability is also ensured when there are gaps between pipe ends which are compensated. Given outside pipe diameters of >180 mm, the FLEX type is suitable for high pressure and the FLEX E type for low pressure applications.



Advantages at a glance

- Compensation of pipe gaps allows thermal elongation of the pipes
- Joining all kind of pipe materials is possible, e.g., for steel, plastic, cast iron, etc.

Information

- Sizes: 26.9 mm - 1219.1 mm
- Working pressure: 70.0 - 4.0 bar
- Material: AISI 304, AISI 316 Ti
- EPDM:
 - Sizes from 26.9 mm up to 168.3 mm: - 30 °C up to + 125 °C
 - Sizes > 180.0 mm: - 20 °C up to + 80 °C
- NBR: from - 20 °C up to + 80 °C



Materials

W1	W2	W3	W4	W5
	x		x	x

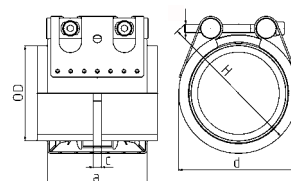
Technical data & Ordering information



Technical data & Ordering information

NORMACONNECT® FGR FLEX											
Ø (O.D.)	Designation	Clamping ranges	PN ¹ (MAWP ¹ from diameter 180)	WP ²	C max	Dimensions			Weight	Hex socket locking bolts	
		O _{dmin} - O _{dmax}	 [bar]	 [bar]	(mm)	a (mm)	d (mm)	H (mm)	approx. (kg/pc.)	Thread	Tightening torque (Nm)
26.9	FLEX 26.9	26.4 - 27.5	16	70	3	67	50	70	0.39	M 8 SW 6	5
28.0	FLEX 28.0	27.5 - 28.5	16	70	3	67	50	70	0.39	M 8 SW 6	5
30.0	FLEX 30.0	29.5 - 30.6	16	70	3	67	50	70	0.39	M 8 SW 6	5
33.7	FLEX 33.7	33.0 - 34.3	16	60	3	67	55	75	0.4	M 8 SW 6	5
35.0	FLEX 35.0	34.5 - 35.6	16	60	8	63	55	75	0.54	M 8 SW 6	5
38.0	FLEX 38.0	37.5 - 38.6	16	60	8	63	60	80	0.54	M 8 SW 6	5
42.4	FLEX 42.4	41.7 - 43.0	16	50	8	63	65	85	0.56	M 8 SW 6	5
44.5	FLEX 44.5	44.0 - 45.1	16	50	8	63	65	85	0.56	M 8 SW 6	5
48.3	FLEX 48.3	47.6 - 50.5	16	50	8	63	70	90	0.58	M 8 SW 6	5
54.0	FLEX 54.0	53.3 - 54.6	16	50	17	78	75	95	0.76	M 8 SW 6	10
57.0	FLEX 57.0	56.3 - 57.7	16	50	17	78	80	100	0.76	M 8 SW 6	10
60.3	FLEX 60.3	59.5 - 61.0	16	40	17	78	85	105	0.77	M 8 SW 6	10
70.0	FLEX 70.0	69.0 - 71.0	16	40	25	98	90	110	1.37	M 8 SW 6	10
73.0	FLEX 73.0	72.1 - 73.8	16	40	25	98	95	115	1.39	M 8 SW 6	10
76.1	FLEX 76.1	75.2 - 77.0	16	35	25	98	100	120	1.39	M 8 SW 6	10
80.0	FLEX 80.0	79.0 - 80.8	16	35	25	98	100	120	1.43	M 8 SW 6	10
84.0	FLEX 84.0	83.0 - 85.0	16	35	25	98	105	125	1.46	M 8 SW 6	10
88.9	FLEX 88.9	87.0 - 89.9	16	35	25	98	110	130	1.47	M 8 SW 6	10
101.6	FLEX 101.6	100.4 - 102.8	16	35	25	98	125	145	1.61	M 8 SW 6	10
104.0	FLEX 104.0	102.8 - 106.1	16	35	25	98	125	145	1.62	M 8 SW 6	10
108.0	FLEX 108.0	106.8 - 109.2	16	35	25	98	130	150	1.64	M 8 SW 6	10
110.0	FLEX 110.0	108.8 - 111.4	16	35	25	98	130	150	1.69	M 8 SW 6	10
114.3	FLEX 114.3	113.0 - 115.5	16	35	25	98	135	155	1.69	M 8 SW 6	15
129.0	FLEX 129.0	127.6 - 131.1	16	32	35	113	155	185	2.41	M 10 SW 8	20
133.0	FLEX 133.0	131.5 - 134.4	16	32	35	113	160	190	2.43	M 10 SW 8	20
139.7	FLEX 139.7	138.1 - 141.6	16	32	35	113	165	195	2.5	M 10 SW 8	25
141.3	FLEX 141.3	139.6 - 142.8	16	32	35	113	170	200	2.5	M 10 SW 8	25
154.0	FLEX 154.0	152.3 - 156.1	16	32	35	113	180	210	2.62	M 10 SW 8	30
159.0	FLEX 159.0	157.3 - 160.7	16	32	35	113	185	215	2.69	M 10 SW 8	30
168.3	FLEX 168.3	166.5 - 170.1	16	32	35	113	195	225	2.75	M 10 SW 8	30
180.0	FLEX 180.0	178.0 - 182.0	23.5	50.0	35	141	210	240	5.4	M 12 SW 10	35
193.7	FLEX 193.7	192.0 - 196.0	23.5	46.0	35	141	225	255	5.6	M 12 SW 10	35
206.0	FLEX 206.0	202.0 - 208.0	20.0	43.0	35	141	240	270	5.8	M 12 SW 10	35
219.0	FLEX 219.0	216.0 - 221.0	18.0	40.5	35	141	250	280	6.0	M 12 SW 10	35
225.0	FLEX 225.0	222.0 - 227.0	18.0	40.0	35	141	255	285	6.1	M 12 SW 10	35
229.9	FLEX 229.9	228.0 - 232.0	18.0	39.0	35	141	260	290	6.2	M 12 SW 10	35
244.5	FLEX 244.5	242.0 - 247.0	18.0	37.0	35	141	275	305	6.4	M 12 SW 10	35
254.0	FLEX 254.0	250.0 - 256.0	18.0	35.5	35	141	285	315	6.5	M 12 SW 10	35
267.0	FLEX 267.0	264.0 - 269.0	18.0	33.5	35	141	300	330	6.7	M 12 SW 10	35
273.0	FLEX 273.0	270.0 - 275.0	17.0	33.0	35	141	305	335	6.8	M 12 SW 10	35
306.0	FLEX 306.0	302.0 - 308.0	15.0	29.0	35	141	340	370	7.4	M 12 SW 10	35
323.9	FLEX 323.9	320.0 - 327.0	15.0	28.0	35	141	355	385	7.6	M 12 SW 10	35
326.0	FLEX 326.0	322.0 - 329.0	13.0	27.5	35	141	360	390	7.7	M 12 SW 10	35
355.6	FLEX 355.6	352.0 - 359.0	13.0	25.0	35	141	390	420	8.1	M 12 SW 10	35
406.4	FLEX 406.4	402.0 - 410.0	10.0	22.0	35	141	440	470	8.9	M 12 SW 10	35
429.0	FLEX 429.0	426.0 - 431.0	7.5	21.0	35	141	460	490	9.3	M 12 SW 10	40
442.0	FLEX 442.0	439.0 - 444.0	7.5	20.0	35	141	475	505	9.5	M 12 SW 10	40
457.2	FLEX 457.2	454.0 - 459.0	7.5	19.5	35	141	490	520	9.7	M 12 SW 10	40
508.0	FLEX 508.0	505.0 - 510.0	7.5	17.0	35	141	540	570	10.5	M 12 SW 10	40
531.0	FLEX 531.0	528.0 - 534.0	7.5	16.0	35	141	565	595	10.9	M 12 SW 10	50
558.8	FLEX 558.8	556.0 - 562.0	7.5	15.5	35	141	590	620	11.3	M 12 SW 10	50
609.6	FLEX 609.6	606.0 - 613.0	6.0	14.0	35	141	640	670	12.1	M 12 SW 10	50
634.0	FLEX 634.0	631.0 - 637.0	5.0	13.5	35	141	665	695	12.5	M 12 SW 10	50
711.2	FLEX 711.2	707.0 - 715.0	5.0	12.0	35	141	745	775	13.7	M 12 SW 10	50
762.0	FLEX 762.0	758.0 - 766.0	4.5	11.0	35	141	795	885	14.5	M 12 SW 10	50
812.8	FLEX 812.8	808.0 - 817.0	4.5	10.5	35	141	845	935	17.2	M 12 SW 10	50
914.4	FLEX 914.4	909.0 - 919.0	3.3	9.5	35	141	945	1035	18.8	M 12 SW 10	60
1016.0	FLEX 1016.0	1013.0 - 1019.0	3.3	8.0	35	141	1050	1140	20.4	M 12 SW 10	60
1117.5	FLEX 1117.5	1114.0 - 1120.0	3.3	7.5	35	141	1150	1240	22.0	M 12 SW 10	60
1219.2	FLEX 1219.2	1216.0 - 1222.0	3.3	7.0	35	141	1250	1340	23.6	M 12 SW 10	60

Coupling sizes >800 mm are in 2-parts design! Sizes > 1219.2 on request

PN¹ (Nominal Pressure) is the max. admissible working pressure in shipbuilding, based on a safety factor of ≥ 4.

MAWP¹ (Maximum Allowable Working Pressure) is the max. admissible working pressure in shipbuilding, based on a safety factor of ≥ 4.

WP² is the max. working pressure in industrial applications, with a safety factor as per NORMA specification.

Technical data & Ordering information

NORMACONNECT® FGR FLEX										
Ø (O.D.)	Designation	W2 Product No.			W4 Product No.			W5 Product No.		
		NBR	EPDM	housing wall thckn.	NBR	EPDM	housing wall thckn.	NBR	EPDM	housing wall thckn.
26.9	FLEX 26.9	0573 8400 026	0573 9100 026	1.0 mm	0573 8500 026	0573 9200 026	1.0 mm			
28.0	FLEX 28.0	0573 8400 028	0573 9100 028	1.0 mm	0573 8500 028	0573 9200 028	1.0 mm			
30.0	FLEX 30.0	0573 8400 030	0573 9100 030	1.0 mm	0573 8500 030	0573 9200 030	1.0 mm			
33.7	FLEX 33.7	0573 8400 033	0573 9100 033	1.0 mm	0573 8500 033	0573 9200 033	1.0 mm			
35.0	FLEX 35.0	0573 8400 035	0573 9100 035	1.2 mm	0573 8500 035	0573 9200 035	1.2 mm			
38.0	FLEX 38.0	0573 8400 038	0573 9100 038	1.2 mm	0573 8500 038	0573 9200 038	1.2 mm			
42.4	FLEX 42.4	0573 8400 042	0573 9100 042	1.2 mm	0573 8500 042	0573 9200 042	1.2 mm			
44.5	FLEX 44.5	0573 8400 044	0573 9100 044	1.2 mm	0573 8500 044	0573 9200 044	1.2 mm			
48.3	FLEX 48.3	0573 8400 048	0573 9100 048	1.2 mm	0573 8500 048	0573 9200 048	1.2 mm			
54.0	FLEX 54.0	0573 8400 054	0573 9100 054	1.2 mm	0573 8500 054	0573 9200 054	1.2 mm			
57.0	FLEX 57.0	0573 8400 057	0573 9100 057	1.2 mm	0573 8500 057	0573 9200 057	1.2 mm			
60.3	FLEX 60.3	0573 8400 060	0573 9100 060	1.2 mm	0573 8500 060	0573 9200 060	1.2 mm			
70.0	FLEX 70.0	0573 8400 070	0573 9100 070	1.2 mm	0573 8500 070	0573 9200 070	1.2 mm			
73.0	FLEX 73.0	0573 8400 073	0573 9100 073	1.5 mm	0573 8500 073	0573 9200 073	1.5 mm			
76.1	FLEX 76.1	0573 8400 076	0573 9100 076	1.5 mm	0573 8500 076	0573 9200 076	1.5 mm			
80.0	FLEX 80.0	0573 8400 080	0573 9100 080	1.5 mm	0573 8500 080	0573 9200 080	1.5 mm			
84.0	FLEX 84.0	0573 8400 084	0573 9100 084	1.5 mm	0573 8500 084	0573 9200 084	1.5 mm			
88.9	FLEX 88.9	0573 8400 088	0573 9100 088	1.5 mm	0573 8500 088	0573 9200 088	1.5 mm			
101.6	FLEX 101.6	0573 8400 101	0573 9100 101	1.5 mm	0573 8500 101	0573 9200 101	1.5 mm			
104.0	FLEX 104.0	0573 8400 104	0573 9100 104	1.5 mm	0573 8500 104	0573 9200 104	1.5 mm			
108.0	FLEX 108.0	0573 8400 108	0573 9100 108	1.5 mm	0573 8500 108	0573 9200 108	1.5 mm			
110.0	FLEX 110.0	0573 8400 110	0573 9100 110	1.5 mm	0573 8500 110	0573 9200 110	1.5 mm			
114.3	FLEX 114.3	0573 8400 114	0573 9100 114	1.5 mm	0573 8500 114	0573 9200 114	1.5 mm			
129.0	FLEX 129.0	0573 8400 129	0573 9100 129	1.5 mm	0573 8500 129	0573 9200 129	1.5 mm			
133.0	FLEX 133.0	0573 8400 133	0573 9100 133	1.5 mm	0573 8500 133	0573 9200 133	1.5 mm			
139.7	FLEX 139.7	0573 8400 139	0573 9100 139	1.5 mm	0573 8500 139	0573 9200 139	1.5 mm			
141.3	FLEX 141.3	0573 8400 141	0573 9100 141	1.5 mm	0573 8500 141	0573 9200 141	1.5 mm			
154.0	FLEX 154.0	0573 8400 154	0573 9100 154	1.5 mm	0573 8500 154	0573 9200 154	1.5 mm			
159.0	FLEX 159.0	0573 8400 159	0573 9100 159	1.5 mm	0573 8500 159	0573 9200 159	1.5 mm			
168.3	FLEX 168.3	0573 8400 168	0573 9100 168	1.5 mm	0573 8500 168	0573 9200 168	1.5 mm			
180.0	FLEX 180.0	0575 844. ...	0575 814 ...	2.5 mm	0575 854. ...	0575 824. ...	2.5 mm	0575 864. ...	0575 834. ...	2.5 mm
193.7	FLEX 193.7	0575 844. ...	0575 814 ...	2.5 mm	0575 854. ...	0575 824. ...	2.5 mm	0575 864. ...	0575 834. ...	2.5 mm
206.0	FLEX 206.0	0575 844. ...	0575 814 ...	2.5 mm	0575 854. ...	0575 824. ...	2.5 mm	0575 864. ...	0575 834. ...	2.5 mm
219.0	FLEX 219.0	0575 844. ...	0575 814 ...	2.5 mm	0575 854. ...	0575 824. ...	2.5 mm	0575 864. ...	0575 834. ...	2.5 mm
225.0	FLEX 225.0	0575 844. ...	0575 814 ...	2.5 mm	0575 854. ...	0575 824. ...	2.5 mm	0575 864. ...	0575 834. ...	2.5 mm
229.9	FLEX 229.9	0575 844. ...	0575 814 ...	2.5 mm	0575 854. ...	0575 824. ...	2.5 mm	0575 864. ...	0575 834. ...	2.5 mm
244.5	FLEX 244.5	0575 844. ...	0575 814 ...	2.5 mm	0575 854. ...	0575 824. ...	2.5 mm	0575 864. ...	0575 834. ...	2.5 mm
254.0	FLEX 254.0	0575 844. ...	0575 814 ...	2.5 mm	0575 854. ...	0575 824. ...	2.5 mm	0575 864. ...	0575 834. ...	2.5 mm
267.0	FLEX 267.0	0575 844. ...	0575 814 ...	2.5 mm	0575 854. ...	0575 824. ...	2.5 mm	0575 864. ...	0575 834. ...	2.5 mm
273.0	FLEX 273.0	0575 844. ...	0575 814 ...	2.5 mm	0575 854. ...	0575 824. ...	2.5 mm	0575 864. ...	0575 834. ...	2.5 mm
306.0	FLEX 306.0	0575 844. ...	0575 814 ...	2.5 mm	0575 854. ...	0575 824. ...	2.5 mm	0575 864. ...	0575 834. ...	2.5 mm
323.9	FLEX 323.9	0575 844. ...	0575 814 ...	2.5 mm	0575 854. ...	0575 824. ...	2.5 mm	0575 864. ...	0575 834. ...	2.5 mm
326.0	FLEX 326.0	0575 844. ...	0575 814 ...	2.5 mm	0575 854. ...	0575 824. ...	2.5 mm	0575 864. ...	0575 834. ...	2.5 mm
355.6	FLEX 355.6	0575 844. ...	0575 814 ...	2.5 mm	0575 854. ...	0575 824. ...	2.5 mm	0575 864. ...	0575 834. ...	2.5 mm
406.4	FLEX 406.4	0575 844. ...	0575 814 ...	2.5 mm	0575 854. ...	0575 824. ...	2.5 mm	0575 864. ...	0575 834. ...	2.5 mm
429.0	FLEX 429.0	0575 844. ...	0575 814 ...	2.5 mm	0575 854. ...	0575 824. ...	2.5 mm	0575 864. ...	0575 834. ...	2.5 mm
442.0	FLEX 442.0	0575 844. ...	0575 814 ...	2.5 mm	0575 854. ...	0575 824. ...	2.5 mm	0575 864. ...	0575 834. ...	2.5 mm
457.2	FLEX 457.2	0575 844. ...	0575 814 ...	2.5 mm	0575 854. ...	0575 824. ...	2.5 mm	0575 864. ...	0575 834. ...	2.5 mm
508.0	FLEX 508.0	0575 844. ...	0575 814 ...	2.5 mm	0575 854. ...	0575 824. ...	2.5 mm	0575 864. ...	0575 834. ...	2.5 mm
531.0	FLEX 531.0	0575 844. ...	0575 814 ...	2.5 mm	0575 854. ...	0575 824. ...	2.5 mm	0575 864. ...	0575 834. ...	2.5 mm
558.8	FLEX 558.8	0575 844. ...	0575 814 ...	2.5 mm	0575 854. ...	0575 824. ...	2.5 mm	0575 864. ...	0575 834. ...	2.5 mm
609.6	FLEX 609.6	0575 844. ...	0575 814 ...	2.5 mm	0575 854. ...	0575 824. ...	2.5 mm	0575 864. ...	0575 834. ...	2.5 mm
634.0	FLEX 634.0	0575 844. ...	0575 814 ...	2.5 mm	0575 854. ...	0575 824. ...	2.5 mm	0575 864. ...	0575 834. ...	2.5 mm
711.2	FLEX 711.2	0575 844. ...	0575 814 ...	2.5 mm	0575 854. ...	0575 824. ...	2.5 mm	0575 864. ...	0575 834. ...	2.5 mm
762.0	FLEX 762.0	0575 844. ...	0575 814 ...	2.5 mm	0575 854. ...	0575 824. ...	2.5 mm	0575 864. ...	0575 834. ...	2.5 mm
812.8	FLEX 812.8	0575 8448 ...	0575 8148 ...	2.5 mm	0575 8548 ...	0575 8248 ...	2.5 mm	0575 8648 ...	0575 8348 ...	2.5 mm
914.4	FLEX 914.4	0575 8448 ...	0575 8148 ...	2.5 mm	0575 8548 ...	0575 8248 ...	2.5 mm	0575 8648 ...	0575 8348 ...	2.5 mm
1016.0	FLEX 1016.0	0575 8448 ...	0575 8148 ...	2.5 mm	0575 8548 ...	0575 8248 ...	2.5 mm	0575 8648 ...	0575 8348 ...	2.5 mm
1117.5	FLEX 1117.5	0575 8448 ...	0575 8148 ...	2.5 mm	0575 8548 ...	0575 8248 ...	2.5 mm	0575 8648 ...	0575 8348 ...	2.5 mm
1219.2	FLEX 1219.2	0575 8448 ...	0575 8148 ...	2.5 mm	0575 8548 ...	0575 8248 ...	2.5 mm	0575 8648 ...	0575 8348 ...	2.5 mm

... = Ø without decimals in mm

NORMACONNECT®

FLEX E



NORMACONNECT® FLEX E is used for connecting restrained pipes, metal pipes, stainless pipes, as well as concrete and plastic pipes. This is a hollow trunnions version.

Advantages at a glance

- Hollow trunnions for low pressure applications from diameter 168.3.

Materials

- W2, W4, W5

NORMACONNECT® FGR FLEX E

Ø (O.D.)	Designation	Clamping ranges Odim - Odmax	PN¹ (MAWP¹ from Ø 180) [bar]	WP² [bar]	C max (mm)	Dimensions			Weight approx. (kg/pc.)	Hex socket locking bolts	
						a (mm)	d (mm)	H (mm)		Thread	Tightening torque (Nm)
26.9	FLEX E 26.9	26.4-27.5	16	70	3	67	50	70	0.31	M 8 SW 6	5
28.0	FLEX E 28.0	27.5-28.5	16	70	3	67	50	70	0.31	M 8 SW 6	5
30.0	FLEX E 30.0	29.5-30.6	16	70	3	67	50	70	0.31	M 8 SW 6	5
33.7	FLEX E 33.7	33.0-34.3	16	60	3	67	55	75	0.32	M 8 SW 6	5
35.0	FLEX E 35.0	34.5-35.6	16	60	8	63	55	75	0.43	M 8 SW 6	5
38.0	FLEX E 38.0	37.5-38.6	16	60	8	63	60	80	0.43	M 8 SW 6	5
42.4	FLEX E 42.4	41.7-43.0	16	50	8	63	65	85	0.44	M 8 SW 6	5
44.5	FLEX E 44.5	44.0-45.1	16	50	8	63	65	85	0.45	M 8 SW 6	5
48.3	FLEX E 48.3	47.6-50.5	16	50	8	63	70	90	0.46	M 8 SW 6	5
54.0	FLEX E 54.0	53.3-54.6	16	50	17	78	75	95	0.60	M 8 SW 6	10
57.0	FLEX E 57.0	56.3-57.7	16	50	17	78	80	100	0.61	M 8 SW 6	10
60.3	FLEX E 60.3	59.5-61.0	16	40	17	78	85	105	0.62	M 8 SW 6	10
70.0	FLEX E 70.0	69.0-71.0	16	40	25	98	90	110	1.16	M 8 SW 6	10
73.0	FLEX E 73.0	72.1-73.8	16	40	25	98	95	115	1.18	M 8 SW 6	10
76.1	FLEX E 76.1	75.2-77.0	16	35	25	98	100	120	1.18	M 8 SW 6	10
80.0	FLEX E 80.0	79.0-80.8	16	35	25	98	100	120	1.21	M 8 SW 6	10
84.0	FLEX E 84.0	83.0-85.0	16	35	25	98	105	125	1.24	M 8 SW 6	10
88.9	FLEX E 88.9	87.0-89.9	16	35	25	98	110	130	1.26	M 8 SW 6	10
101.6	FLEX E 101.6	100.4-102.8	16	35	25	98	125	145	1.39	M 8 SW 6	10
104.0	FLEX E 104.0	102.8-106.1	16	35	25	98	125	145	1.40	M 8 SW 6	10
108.0	FLEX E 108.0	106.8-109.2	16	35	25	98	130	150	1.42	M 8 SW 6	10
110.0	FLEX E 110.0	108.8-111.4	16	35	25	98	130	150	1.47	M 8 SW 6	10
114.3	FLEX E 114.3	113.0-115.5	16	35	25	98	135	155	1.47	M 8 SW 6	15
129.0	FLEX E 129.0	127.6-131.1	16	32	35	113	155	185	2.10	M 10 SW 8	20
133.0	FLEX E 133.0	131.5-134.4	16	32	35	113	160	190	2.13	M 10 SW 8	20
139.7	FLEX E 139.7	138.1-141.6	16	32	35	113	165	195	2.19	M 10 SW 8	25
141.3	FLEX E 141.3	139.6-142.8	16	32	35	113	170	200	2.19	M 10 SW 8	25
154.0	FLEX E 154.0	152.3-156.1	16	32	35	113	180	210	2.31	M 10 SW 8	30
159.0	FLEX E 159.0	157.3-160.7	16	32	35	113	185	215	2.38	M 10 SW 8	30
168.3	FLEX E 168.3	166.5 - 170.1	16	32	35	113	195	225	2.43	M 10 SW 8	30
180.0	FLEX E 180.0	178.0 - 182.0	13.5	30.0	35	139	210	240	4.0	M 12 SW 10	25
193.7	FLEX E 193.7	192.0 - 196.0	13.5	28.0	35	139	225	255	4.1	M 12 SW 10	25
206.0	FLEX E 206.0	202.0 - 208.0	13.5	26.5	35	139	240	270	4.3	M 12 SW 10	25
219.0	FLEX E 219.0	216.0 - 221.0	13.5	23.0	35	139	250	280	4.4	M 12 SW 10	25
225.0	FLEX E 225.0	222.0 - 227.0	12.0	23.0	35	139	255	285	4.5	M 12 SW 10	25
229.9	FLEX E 229.9	228.0 - 232.0	12.0	23.0	35	139	260	290	4.5	M 12 SW 10	25
244.5	FLEX E 244.5	242.0 - 247.0	12.0	22.0	35	139	275	305	4.7	M 12 SW 10	25
254.0	FLEX E 254.0	250.0 - 256.0	12.0	21.0	35	139	285	315	4.8	M 12 SW 10	25
267.0	FLEX E 267.0	264.0 - 269.0	12.0	20.0	35	139	300	330	5.0	M 12 SW 10	25
273.0	FLEX E 273.0	270.0 - 275.0	12.0	20.0	35	139	305	335	5.1	M 12 SW 10	25
306.0	FLEX E 306.0	302.0 - 308.0	9.0	17.5	35	139	340	370	5.5	M 12 SW 10	25
323.9	FLEX E 323.9	320.0 - 327.0	9.0	17.5	35	139	355	385	5.7	M 12 SW 10	25
326.0	FLEX E 326.0	322.0 - 329.0	9.0	16.5	35	139	360	390	5.7	M 12 SW 10	25
355.6	FLEX E 355.6	352.0 - 359.0	9.0	15.0	35	139	390	420	6.0	M 12 SW 10	25
406.4	FLEX E 406.4	402.0 - 410.0	7.5	14.0	35	139	440	470	6.7	M 12 SW 10	25
429.0	FLEX E 429.0	426.0 - 431.0	5.5	13.0	35	139	460	490	6.9	M 12 SW 10	40
442.0	FLEX E 442.0	439.0 - 444.0	5.5	13.0	35	139	475	505	7.1	M 12 SW 10	40
457.2	FLEX E 457.2	454.0 - 459.0	5.5	12.0	35	139	490	520	7.3	M 12 SW 10	40
508.0	FLEX E 508.0	505.0 - 510.0	5.5	11.0	35	139	540	570	7.9	M 12 SW 10	40
531.0	FLEX E 531.0	528.0 - 534.0	5.5	10.5	35	139	565	595	8.1	M 12 SW 10	40
558.8	FLEX E 558.8	556.0 - 562.0	5.5	10.0	35	139	590	620	8.5	M 12 SW 10	40
609.6	FLEX E 609.6	606.0 - 613.0	4.5	9.0	35	139	640	670	9.1	M 12 SW 10	40
634.0	FLEX E 634.0	631.0 - 637.0	4.5	8.0	35	139	665	695	9.4	M 12 SW 10	40
711.2	FLEX E 711.2	707.0 - 715.0	4.0	7.0	35	139	745	775	10.3	M 12 SW 10	40
762.0	FLEX E 762.0	758.0 - 766.0	3.2	7.0	35	139	795	885	10.9	M 12 SW 10	40
812.8	FLEX E 812.8	808.0 - 817.0	3.2	6.5	35	139	845	935	12.8	M 12 SW 10	40
914.4	FLEX E 914.4	909.0 - 919.0	2.0	5.5	35	139	945	1035	14.0	M 12 SW 10	45
1016.0	FLEX E 1016.0	1013.0 - 1019.0	2.0	5.0	35	139	1050	1140	15.2	M 12 SW 10	45
1117.5	FLEX E 1117.5	1114.0 - 1120.0	2.0	4.5	35	139	1150	1240	16.4	M 12 SW 10	50
1219.2	FLEX E 1219.2	1216.0 - 1222.0	2.0	4.0	35	139	1250	1340	17.7	M 12 SW 10	50

Coupling sizes >800 mm are in 2-parts design! Sizes > 1219.2 on request

PN¹ (Nominal Pressure) is the max. admissible working pressure in shipbuilding, based on a safety factor of ≥ 4.

MAWP¹ (Maximum Allowable Working Pressure) is the max. admissible working pressure in shipbuilding, based on a safety factor of ≥ 4.

WP² is the max. working pressure in industrial applications, with a safety factor as per NORMA specification.

Technical data & Ordering information

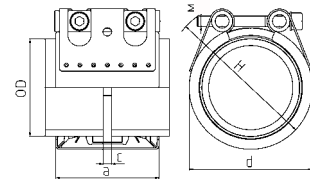

... = Ø without decimals in mm

NORMACONNECT® FGR FLEX E										
Ø (O.D.)	Designation	W2 Product No.			W4 Product No.			W5 Product No.		
		NBR	EPDM	housing wall thickn.	NBR	EPDM	housing wall thickn.	NBR	EPDM	housing wall thickn.
26.9	FLEX E 26.9	0582 8400 026	0582 9100 026	1.0 mm	0582 8500 026	0582 9200 026	1.0 mm	0582 8600 026	0582 9300 026	1.0 mm
28.0	FLEX E 28.0	0582 8400 028	0582 9100 028	1.0 mm	0582 8500 028	0582 9200 028	1.0 mm	0582 8600 028	0582 9300 028	1.0 mm
30.0	FLEX E 30.0	0582 8400 030	0582 9100 030	1.0 mm	0582 8500 030	0582 9200 030	1.0 mm	0582 8600 030	0582 9300 030	1.0 mm
33.7	FLEX E 33.7	0582 8400 033	0582 9100 033	1.0 mm	0582 8500 033	0582 9200 033	1.0 mm	0582 8600 033	0582 9300 033	1.0 mm
35.0	FLEX E 35.0	0582 8400 035	0582 9100 035	1.2 mm	0582 8500 035	0582 9200 035	1.2 mm	0582 8600 035	0582 9300 035	1.2 mm
38.0	FLEX E 38.0	0582 8400 038	0582 9100 038	1.2 mm	0582 8500 038	0582 9200 038	1.2 mm	0582 8600 038	0582 9300 038	1.2 mm
42.4	FLEX E 42.4	0582 8400 042	0582 9100 042	1.2 mm	0582 8500 042	0582 9200 042	1.2 mm	0582 8600 042	0582 9300 042	1.2 mm
44.5	FLEX E 44.5	0582 8400 044	0582 9100 044	1.2 mm	0582 8500 044	0582 9200 044	1.2 mm	0582 8600 044	0582 9300 044	1.2 mm
48.3	FLEX E 48.3	0582 8400 048	0582 9100 048	1.2 mm	0582 8500 048	0582 9200 048	1.2 mm	0582 8600 048	0582 9300 048	1.2 mm
54.0	FLEX E 54.0	0582 8400 054	0582 9100 054	1.2 mm	0582 8500 054	0582 9200 054	1.2 mm	0582 8600 054	0582 9300 054	1.2 mm
57.0	FLEX E 57.0	0582 8400 057	0582 9100 057	1.2 mm	0582 8500 057	0582 9200 057	1.2 mm	0582 8600 057	0582 9300 057	1.2 mm
60.3	FLEX E 60.3	0582 8400 060	0582 9100 060	1.2 mm	0582 8500 060	0582 9200 060	1.2 mm	0582 8600 060	0582 9300 060	1.2 mm
70.0	FLEX E 70.0	0582 8400 070	0582 9100 070	1.2 mm	0582 8500 070	0582 9200 070	1.2 mm	0582 8600 070	0582 9300 070	1.2 mm
73.0	FLEX E 73.0	0582 8400 073	0582 9100 073	1.5 mm	0582 8500 073	0582 9200 073	1.5 mm	0582 8600 073	0582 9300 073	1.5 mm
76.1	FLEX E 76.1	0582 8400 076	0582 9100 076	1.5 mm	0582 8500 076	0582 9200 076	1.5 mm	0582 8600 076	0582 9300 076	1.5 mm
80.0	FLEX E 80.0	0582 8400 080	0582 9100 080	1.5 mm	0582 8500 080	0582 9200 080	1.5 mm	0582 8600 080	0582 9300 080	1.5 mm
84.0	FLEX E 84.0	0582 8400 084	0582 9100 084	1.5 mm	0582 8500 084	0582 9200 084	1.5 mm	0582 8600 084	0582 9300 084	1.5 mm
88.9	FLEX E 88.9	0582 8400 088	0582 9100 088	1.5 mm	0582 8500 088	0582 9200 088	1.5 mm	0582 8600 088	0582 9300 088	1.5 mm
101.6	FLEX E 101.6	0582 8400 101	0582 9100 101	1.5 mm	0582 8500 101	0582 9200 101	1.5 mm	0582 8600 101	0582 9300 101	1.5 mm
104.0	FLEX E 104.0	0582 8400 104	0582 9100 104	1.5 mm	0582 8500 104	0582 9200 104	1.5 mm	0582 8600 104	0582 9300 104	1.5 mm
108.0	FLEX E 108.0	0582 8400 108	0582 9100 108	1.5 mm	0582 8500 108	0582 9200 108	1.5 mm	0582 8600 108	0582 9300 108	1.5 mm
110.0	FLEX E 110.0	0582 8400 110	0582 9100 110	1.5 mm	0582 8500 110	0582 9200 110	1.5 mm	0582 8600 110	0582 9300 110	1.5 mm
114.3	FLEX E 114.3	0582 8400 114	0582 9100 114	1.5 mm	0582 8500 114	0582 9200 114	1.5 mm	0582 8600 114	0582 9300 114	1.5 mm
129.0	FLEX E 129.0	0582 8400 129	0582 9100 129	1.5 mm	0582 8500 129	0582 9200 129	1.5 mm	0582 8600 129	0582 9300 129	1.5 mm
133.0	FLEX E 133.0	0582 8400 133	0582 9100 133	1.5 mm	0582 8500 133	0582 9200 133	1.5 mm	0582 8600 133	0582 9300 133	1.5 mm
139.7	FLEX E 139.7	0582 8400 139	0582 9100 139	1.5 mm	0582 8500 139	0582 9200 139	1.5 mm	0582 8600 139	0582 9300 139	1.5 mm
141.3	FLEX E 141.3	0582 8400 141	0582 9100 141	1.5 mm	0582 8500 141	0582 9200 141	1.5 mm	0582 8600 141	0582 9300 141	1.5 mm
154.0	FLEX E 154.0	0582 8400 154	0582 9100 154	1.5 mm	0582 8500 154	0582 9200 154	1.5 mm	0582 8600 154	0582 9300 154	1.5 mm
159.0	FLEX E 159.0	0582 8400 159	0582 9100 159	1.5 mm	0582 8500 159	0582 9200 159	1.5 mm	0582 8600 159	0582 9300 159	1.5 mm
168.3	FLEX E 168.3	0582 8400 168	0582 9100 168	1.5 mm	0582 8500 168	0582 9200 168	1.5 mm	0582 8600 168	0582 9300 168	1.5 mm
180.0	FLEX E 180.0	0583 842. ...	0583 812. ...	1.5 mm	0583 852. ...	0583 822. ...	1.5 mm	0583 862. ...	0583 832. ...	1.5 mm
193.7	FLEX E 193.7	0583 842. ...	0583 812. ...	1.5 mm	0583 852. ...	0583 822. ...	1.5 mm	0583 862. ...	0583 832. ...	1.5 mm
206.0	FLEX E 206.0	0583 842. ...	0583 812. ...	1.5 mm	0583 852. ...	0583 822. ...	1.5 mm	0583 862. ...	0583 832. ...	1.5 mm
219.0	FLEX E 219.0	0583 842. ...	0583 812. ...	1.5 mm	0583 852. ...	0583 822. ...	1.5 mm	0583 862. ...	0583 832. ...	1.5 mm
225.0	FLEX E 225.0	0583 842. ...	0583 812. ...	1.5 mm	0583 852. ...	0583 822. ...	1.5 mm	0583 862. ...	0583 832. ...	1.5 mm
229.9	FLEX E 229.9	0583 842. ...	0583 812. ...	1.5 mm	0583 852. ...	0583 822. ...	1.5 mm	0583 862. ...	0583 832. ...	1.5 mm
244.5	FLEX E 244.5	0583 842. ...	0583 812. ...	1.5 mm	0583 852. ...	0583 822. ...	1.5 mm	0583 862. ...	0583 832. ...	1.5 mm
254.0	FLEX E 254.0	0583 842. ...	0583 812. ...	1.5 mm	0583 852. ...	0583 822. ...	1.5 mm	0583 862. ...	0583 832. ...	1.5 mm
267.0	FLEX E 267.0	0583 842. ...	0583 812. ...	1.5 mm	0583 852. ...	0583 822. ...	1.5 mm	0583 862. ...	0583 832. ...	1.5 mm
273.0	FLEX E 273.0	0583 842. ...	0583 812. ...	1.5 mm	0583 852. ...	0583 822. ...	1.5 mm	0583 862. ...	0583 832. ...	1.5 mm
306.0	FLEX E 306.0	0583 842. ...	0583 812. ...	1.5 mm	0583 852. ...	0583 822. ...	1.5 mm	0583 862. ...	0583 832. ...	1.5 mm
323.9	FLEX E 323.9	0583 842. ...	0583 812. ...	1.5 mm	0583 852. ...	0583 822. ...	1.5 mm	0583 862. ...	0583 832. ...	1.5 mm
326.0	FLEX E 326.0	0583 842. ...	0583 812. ...	1.5 mm	0583 852. ...	0583 822. ...	1.5 mm	0583 862. ...	0583 832. ...	1.5 mm
355.6	FLEX E 355.6	0583 842. ...	0583 812. ...	1.5 mm	0583 852. ...	0583 822. ...	1.5 mm	0583 862. ...	0583 832. ...	1.5 mm
406.4	FLEX E 406.4	0583 842. ...	0583 812. ...	1.5 mm	0583 852. ...	0583 822. ...	1.5 mm	0583 862. ...	0583 832. ...	1.5 mm
429.0	FLEX E 429.0	0583 842. ...	0583 812. ...	1.5 mm	0583 852. ...	0583 822. ...	1.5 mm	0583 862. ...	0583 832. ...	1.5 mm
442.0	FLEX E 442.0	0583 842. ...	0583 812. ...	1.5 mm	0583 852. ...	0583 822. ...	1.5 mm	0583 862. ...	0583 832. ...	1.5 mm
457.2	FLEX E 457.2	0583 842. ...	0583 812. ...	1.5 mm	0583 852. ...	0583 822. ...	1.5 mm	0583 862. ...	0583 832. ...	1.5 mm
508.0	FLEX E 508.0	0583 842. ...	0583 812. ...	1.5 mm	0583 852. ...	0583 822. ...	1.5 mm	0583 862. ...	0583 832. ...	1.5 mm
531.0	FLEX E 531.0	0583 842. ...	0583 812. ...	1.5 mm	0583 852. ...	0583 822. ...	1.5 mm	0583 862. ...	0583 832. ...	1.5 mm
558.8	FLEX E 558.8	0583 842. ...	0583 812. ...	1.5 mm	0583 852. ...	0583 822. ...	1.5 mm	0583 862. ...	0583 832. ...	1.5 mm
609.6	FLEX E 609.6	0583 842. ...	0583 812. ...	1.5 mm	0583 852. ...	0583 822. ...	1.5 mm	0583 862. ...	0583 832. ...	1.5 mm
634.0	FLEX E 634.0	0583 842. ...	0583 812. ...	1.5 mm	0583 852. ...	0583 822. ...	1.5 mm	0583 862. ...	0583 832. ...	1.5 mm
711.2	FLEX E 711.2	0583 842. ...	0583 812. ...	1.5 mm	0583 852. ...	0583 822. ...	1.5 mm	0583 862. ...	0583 832. ...	1.5 mm
762.0	FLEX E 762.0	0583 842. ...	0583 812. ...	1.5 mm	0583 852. ...	0583 822. ...	1.5 mm	0583 862. ...	0583 832. ...	1.5 mm
812.8	FLEX E 812.8	0583 8428 ...	0583 8128 ...	1.5 mm	0583 8528 ...	0583 8228 ...	1.5 mm	0583 8628 ...	0583 8328 ...	1.5 mm
914.4	FLEX E 914.4	0583 8428 ...	0583 8128 ...	1.5 mm	0583 8528 ...	0583 8228 ...	1.5 mm	0583 8628 ...	0583 8328 ...	1.5 mm
1016.0	FLEX E 1016.0	0583 8428 ...	0583 8128 ...	1.5 mm	0583 8528 ...	0583 8228 ...	1.5 mm	0583 8628 ...	0583 8328 ...	1.5 mm
1117.5	FLEX E 1117.5	0583 8428 ...	0583 8128 ...	1.5 mm	0583 8528 ...	0583 8228 ...	1.5 mm	0583 8628 ...	0583 8328 ...	1.5 mm
1219.2	FLEX E 1219.2	0583 8428 ...	0583 8128 ...	1.5 mm	0583 8528 ...	0583 8228 ...	1.5 mm	0583 8628 ...	0583 8328 ...	1.5 mm



- 1 Double-lip sealing system
- 2 Standard strip insert
- 3 Heavy duty lock bars



NORMACONNECT® FLEX 3 pipe coupling with extra wide band width of 211 mm

The pipe coupling with extra wide band

NORMACONNECT® FLEX 3 featuring an extra wide band is an axial non-restraint coupling used to connect metal and/or plastic pipes quickly and safely.



Advantages at a glance

- Easy and quick to assemble
- Pipe end distance up to 65 mm possible
- Compensation of misalignment, angular deflection up to 4° possible

Information

- Sizes: from 326.0 mm to 2032.0 mm
- Working pressure: 16.5 bar - 1.5 bar
- Solid trunnions
- 2 closure units from size > 800.0 mm
- Material: AISI 316 Ti
- EPDM: Sizes > 180.0 mm: - 20 °C up to + 80 °C
- NBR: from - 20 °C up to + 80 °C

Materials

W1	W2	W3	W4	W5
				x

Technical data & Ordering information

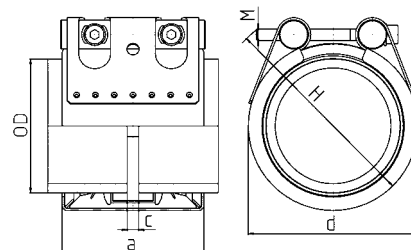

Technical data & Ordering information

NORMACONNECT® FGR FLEX 3													
Ø (O.D.)	Designation	Clamping ranges	WP ¹	C max	Dimensions			Weight	Hex socket locking bolts		W5 Product No.		
		O _{dmin} - O _{dmax}	 [bar]	(mm)	a (mm)	d (mm)	H (mm)	approx. (kg/pc.)	Thread	Tightening torque (Nm)	NBR	EPDM	housing wall thickn.
326.0	FLEX 3 326.0	322.0 - 329.0	16.5	65	211	365	405	11.9	M 16 SW 14	30	0571 8630 ...	0571 8330 ...	2.0mm
355.6	FLEX 3 355.6	352.0 - 259.0	15.5	65	211	395	435	12.4	M 16 SW 14	35	0571 8630 ...	0571 8330 ...	2.0mm
406.4	FLEX 3 406.4	402.0 - 410.0	13.5	65	211	445	485	13.4	M 16 SW 14	35	0571 8630 ...	0571 8330 ...	2.0mm
429.0	FLEX 3 429.0	426.0 - 431.0	12.5	65	211	465	505	13.9	M 16 SW 14	35	0571 8630 ...	0571 8330 ...	2.0mm
442.0	FLEX 3 442.0	439.0 - 444.0	12.0	65	211	480	520	14.1	M 16 SW 14	35	0571 8630 ...	0571 8330 ...	2.0mm
457.2	FLEX 3 457.2	454.0 - 459.0	12.0	65	211	495	535	14.4	M 16 SW 14	35	0571 8630 ...	0571 8330 ...	2.0mm
508.0	FLEX 3 508.0	505.0 - 510.0	10.5	65	211	545	585	15.4	M 16 SW 14	35	0571 8630 ...	0571 8330 ...	2.0mm
531.0	FLEX 3 531.0	528.0 - 534.0	10.0	65	211	570	610	15.9	M 16 SW 14	35	0571 8630 ...	0571 8330 ...	2.0mm
558.8	FLEX 3 558.8	556.0 - 562.0	9.5	65	211	595	635	16.4	M 16 SW 14	35	0571 8630 ...	0571 8330 ...	2.0mm
609.6	FLEX 3 609.6	606.0 - 613.0	9.0	65	211	645	685	17.4	M 16 SW 14	40	0571 8630 ...	0571 8330 ...	2.0mm
634.0	FLEX 3 634.0	631.0 - 637.0	8.5	65	211	670	710	17.9	M 16 SW 14	40	0571 8630 ...	0571 8330 ...	2.0mm
711.2	FLEX 3 711.2	707.0 - 715.0	7.5	65	211	750	790	19.4	M 16 SW 14	40	0571 8630 ...	0571 8330 ...	2.0mm
762.0	FLEX 3 762.0	758.0 - 766.0	7.0	65	211	800	840	20.4	M 16 SW 14	40	0571 8630 ...	0571 8330 ...	2.0mm
812.8	FLEX 3 812.8	808.0 - 817.0	6.5	65	211	850	890	21.4	M 16 SW 14	45	0571 8638 ...	0571 8338 ...	2.0mm
914.4	FLEX 3 914.4	909.0 - 919.0	6.0	65	211	950	990	23.4	M 16 SW 14	45	0571 8638 ...	0571 8338 ...	2.0mm
1016.0	FLEX 3 1016.0	1013.0 - 1019.0	5.0	65	211	1055	1095	25.4	M 16 SW 14	50	0571 8638 ...	0571 8338 ...	2.0mm
1117.5	FLEX 3 1117.5	1114.0 - 1120.0	4.5	65	211	1155	1195	27.4	M 16 SW 14	50	0571 8638 ...	0571 8338 ...	2.0mm
1219.2	FLEX 3 1219.2	1216.0 - 1222.0	4.0	65	211	1255	1295	29.4	M 16 SW 14	55	0571 8638 ...	0571 8338 ...	2.0mm
1320.8	FLEX 3 1320.8	1314.0 - 1328.0	3.0	65	211	1360	1400	31.4	M 16 SW 14	55	0571 8638 ...	0571 8338 ...	2.0mm
1422.4	FLEX 3 1422.4	1415.0 - 1430.0	3.0	65	211	1460	1500	33.4	M 16 SW 14	60	0571 8638 ...	0571 8338 ...	2.0mm
1524.0	FLEX 3 1524.0	1516.0 - 1532.0	2.5	65	211	1560	1600	35.4	M 16 SW 14	60	0571 8638 ...	0571 8338 ...	2.0mm
1625.6	FLEX 3 1625.6	1617.0 - 1634.0	2.5	65	211	1665	1705	37.4	M 16 SW 14	70	0571 8638 ...	0571 8338 ...	2.0mm
1727.2	FLEX 3 1727.2	1718.0 - 1736.0	2.0	65	211	1765	1805	39.4	M 16 SW 14	70	0571 8638 ...	0571 8338 ...	2.0mm
1828.8	FLEX 3 1828.8	1819.0 - 1838.0	2.0	65	211	1865	1905	41.4	M 16 SW 14	80	0571 8638 ...	0571 8338 ...	2.0mm
1930.4	FLEX 3 1930.4	1320.0 - 1940.0	2.0	65	211	1970	2010	43.4	M 16 SW 14	80	0571 8638 ...	0571 8338 ...	2.0mm
2032.0	FLEX 3 2032.0	2021.0 - 2042.0	1.5	65	211	2070	2110	45.4	M 16 SW 14	80	0571 8638 ...	0571 8338 ...	2.0mm

Coupling sizes >800 mm are in 2-parts design!

WP¹ is the max. working pressure in industrial applications, with a safety factor as per NORMA specification.

... = Ø without decimals in mm

NORMACONNECT®

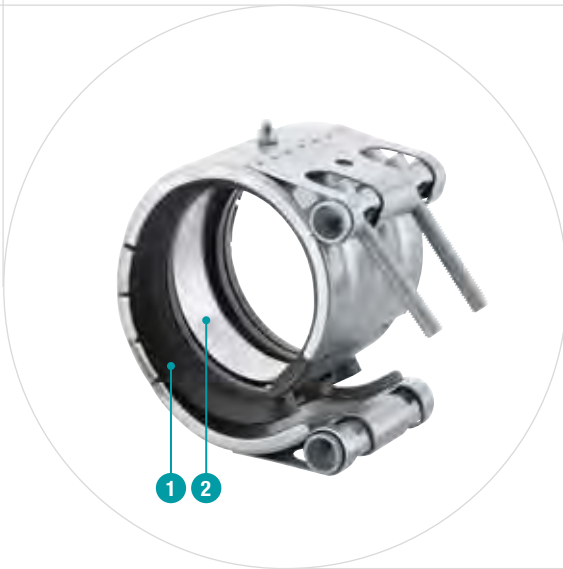

- 1 Double-lip sealing system
- 2 Standard strip insert

The repair coupling

NORMACONNECT® REP E are non-restraint repair couplings. They are used to connect and/or seal damaged metal and plastic pipes. They also enable repairs to be carried out easily, quickly and safely without the need to dismantle the pipes.

Advantages at a glance

- Ensures a reliable, safe, leakage-free connection
- Enables easy, quick and safe repair without dismantling the pipes
- Easy to install without special tools

Information

- Sizes: from 35.0 mm to 1219.1 mm
- Working pressure: from 60.0 bar to 4.0 bar
- Material: AISI 316 Ti
- EPDM:
 - Sizes from 26.9 mm up to 168.3 mm: - 30 °C up to + 125 °C
 - Sizes > 180.0 mm: - 20 °C up to + 80 °C
- NBR : from - 20 °C up to + 80 °C

Materials

W1	W2	W3	W4	W5
				x

Technical data & Ordering information

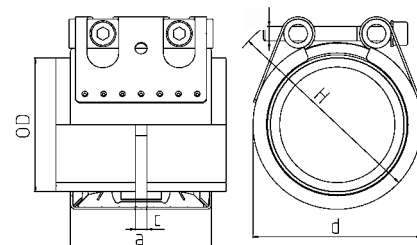

Technical data & Ordering information

NORMACONNECT® FGR REP E													
Ø (O.D.)	Designation	Clamping ranges	WP ¹ 	C max (mm)	Dimensions			Weight approx. (kg/pc.)	Hex socket locking bolts		W5 Product No.		
		Odmin - Odmax			a (mm)	d (mm)	H (mm)		Thread	Tightening torque (Nm)	NBR	EPDM	housing wall thckn.
35.0	REP E W5 35.0	34.5 - 35.6	60	8	63	55	75	0.41	M 8 SW 6	5	0572 8660 035	0572 9360 035	1.2 mm
38.0	REP E W5 38.0	37.5 - 38.6	60	8	63	60	80	0.41	M 8 SW 6	5	0572 8660 038	0572 9360 038	1.2 mm
42.4	REP E W5 42.4	41.7 - 43.0	50	8	63	65	85	0.42	M 8 SW 6	5	5728 8660 042	0572 9360 042	1.2 mm
44.5	REP E W5 44.5	44.0 - 45.1	50	8	63	65	85	0.43	M 8 SW 6	5	0572 8660 044	0572 9360 044	1.2 mm
48.3	REP E W5 48.3	47.6 - 50.5	50	8	63	70	90	0.44	M 8 SW 6	5	0572 8660 048	0572 9360 048	1.2 mm
54.0	REP E W5 54.0	53.3 - 54.6	50	17	78	75	95	0.58	M 8 SW 6	10	0572 8660 054	0572 9360 054	1.2 mm
57.0	REP E W5 57.0	56.3 - 57.7	50	17	78	80	100	0.58	M 8 SW 6	10	0572 8660 057	0572 9360 057	1.2 mm
60.3	REP E W5 60.3	59.5 - 61.0	40	17	78	85	105	0.59	M 8 SW 6	10	0572 8660 060	0572 9360 060	1.2 mm
70.0	REP E W5 70.0	69.0 - 71.0	40	25	98	90	110	0.59	M 8 SW 6	10	0572 8660 070	0572 9360 070	1.2 mm
73.0	REP E W5 73.0	72.1 - 73.8	40	25	98	95	115	1.13	M 8 SW 6	10	0572 8660 073	0572 9360 073	1.5 mm
76.1	REP E W5 76.1	75.2 - 77.0	35	25	98	100	120	1.13	M 8 SW 6	10	0572 8660 076	0572 9360 076	1.5 mm
78.0	REP E W5 78.0	77.1 - 78.9	35	25	98	100	120	1.14	M 8 SW 6	15	0572 8660 078	0572 9360 078	1.5 mm
80.0	REP E W5 80.0	79.0 - 80.8	35	25	98	100	120	1.16	M 8 SW 6	15	0572 8660 080	0572 9360 080	1.5 mm
84.0	REP E W5 84.0	83.0 - 85.0	35	25	98	105	125	1.18	M 8 SW 6	15	0572 8660 084	0572 9360 084	1.5 mm
88.9	REP E W5 88.9	87.0 - 89.9	35	25	98	110	130	1.20	M 8 SW 6	15	0572 8660 088	0572 9360 088	1.5 mm
98.0	REP E W5 98.0	96.9 - 99.0	35	25	98	120	140	1.32	M 8 SW 6	15	0572 8660 098	0572 9360 098	1.5 mm
101.6	REP E W5 101.6	100.4 - 102.8	35	25	98	125	145	1.33	M 8 SW 6	15	0572 8660 101	0572 9360 101	1.5 mm
104.0	REP E W5 104.0	102.8 - 106.1	35	25	98	125	145	1.36	M 8 SW 6	15	0572 8660 104	0572 9360 104	1.5 mm
108.0	REP E W5 108.0	106.8 - 109.2	35	25	98	130	150	1.40	M 8 SW 6	15	0572 8660 108	0572 9360 108	1.5 mm
110.0	REP E W5 110.0	108.8 - 111.4	35	25	98	130	150	1.40	M 8 SW 6	20	0572 8660 110	0572 9360 110	1.5 mm
114.3	REP E W5 114.0	113.0 - 115.5	35	25	98	135	155	1.99	M 8 SW 6	30	0572 8660 114	0572 9360 114	1.5 mm
129.0	REP E W5 129.0	127.6 - 131.1	32	35	113	155	185	2.00	M 10 SW 8	30	0572 8660 129	0572 9360 129	1.5 mm
133.0	REP E W5 133.0	131.5 - 134.4	32	35	113	160	190	2.03	M 10 SW 8	30	0572 8660 133	0572 9360 133	1.5 mm
139.7	REP E W5 139.7	138.1 - 141.6	32	35	113	165	195	2.08	M 10 SW 8	30	0572 8660 139	0572 9360 139	1.5 mm
141.3	REP E W5 141.3	139.6 - 142.8	32	35	113	170	200	2.09	M 10 SW 8	35	0572 8660 141	0572 9360 141	1.5 mm
154.0	REP E W5 154.0	152.3 - 156.1	32	35	113	180	210	2.19	M 10 SW 8	50	0572 8660 154	0572 9360 154	1.5 mm
159.0	REP E W5 159.0	157.3 - 160.7	32	35	113	185	215	2.26	M 10 SW 8	50	0572 8660 159	0572 9360 159	1.5 mm
168.3	REP E W5 168.0	166.5 - 170.1	32	35	113	195	225	2.31	M 10 SW 8	50	0572 8660 168	0572 9360 168	1.5 mm
180.0	REP E W5 180.0	178.0 - 182.0	30.0	35	139	210	240	4.0	M 12 SW 10	25	0576 866...	0576 836...	1.5 mm
193.7	REP E W5 193.7	192.0 - 196.0	28.0	35	139	225	255	4.1	M 12 SW 10	25	0576 866...	0576 836...	1.5 mm
206.0	REP E W5 206.0	202.0 - 208.0	26.5	35	139	240	270	4.3	M 12 SW 10	25	0576 866...	0576 836...	1.5 mm
219.0	REP E W5 219.0	216.0 - 221.0	23.0	35	139	250	280	4.4	M 12 SW 10	25	0576 866...	0576 836...	1.5 mm
225.0	REP E W5 225.0	222.0 - 227.0	23.0	35	139	255	285	4.5	M 12 SW 10	25	0576 866...	0576 836...	1.5 mm
229.9	REP E W5 229.9	228.0 - 232.0	23.0	35	139	260	290	4.5	M 12 SW 10	25	0576 866...	0576 836...	1.5 mm
244.5	REP E W5 244.5	242.0 - 247.0	22.0	35	139	275	305	4.7	M 12 SW 10	25	0576 866...	0576 836...	1.5 mm
254.0	REP E W5 254.0	250.0 - 256.0	21.0	35	139	285	315	4.8	M 12 SW 10	25	0576 866...	0576 836...	1.5 mm
267.0	REP E W5 267.0	264.0 - 269.0	20.0	35	139	300	330	5.0	M 12 SW 10	25	0576 866...	0576 836...	1.5 mm
273.0	REP E W5 273.0	270.0 - 275.0	20.0	35	139	305	335	5.1	M 12 SW 10	25	0576 866...	0576 836...	1.5 mm
306.0	REP E W5 306.0	302.0 - 308.0	17.5	35	139	340	370	5.5	M 12 SW 10	25	0576 866...	0576 836...	1.5 mm
323.9	REP E W5 323.9	320.0 - 327.0	17.5	35	139	355	385	5.7	M 12 SW 10	25	0576 866...	0576 836...	1.5 mm
326.0	REP E W5 326.0	322.0 - 329.0	16.5	35	139	360	390	5.7	M 12 SW 10	25	0576 866...	0576 836...	1.5 mm
355.6	REP E W5 355.6	352.0 - 359.0	15.0	35	139	390	420	6.0	M 12 SW 10	25	0576 866...	0576 836...	1.5 mm
406.4	REP E W5 406.4	402.0 - 410.0	14.0	35	139	440	470	6.6	M 12 SW 10	25	0576 866...	0576 836...	1.5 mm
429.0	REP E W5 429.0	426.0 - 431.0	13.0	35	139	460	490	6.9	M 12 SW 10	40	0576 866...	0576 836...	1.5 mm
442.0	REP E W5 442.0	439.0 - 444.0	13.0	35	139	475	505	7.1	M 12 SW 10	40	0576 866...	0576 836...	1.5 mm
457.2	REP E W5 457.2	454.0 - 459.0	12.0	35	139	490	520	7.3	M 12 SW 10	40	0576 866...	0576 836...	1.5 mm
508.0	REP E W5 508.0	505.0 - 510.0	11.0	35	139	540	570	7.9	M 12 SW 10	40	0576 866...	0576 836...	1.5 mm
531.0	REP E W5 531.0	528.0 - 534.0	10.5	35	139	565	595	8.1	M 12 SW 10	40	0576 866...	0576 836...	1.5 mm
558.8	REP E W5 558.8	556.0 - 562.0	10.0	35	139	590	620	8.5	M 12 SW 10	40	0576 866...	0576 836...	1.5 mm
609.6	REP E W5 609.6	606.0 - 613.0	9.0	35	139	640	670	9.1	M 12 SW 10	40	0576 866...	0576 836...	1.5 mm
634.0	REP E W5 634.0	631.0 - 637.0	8.0	35	139	665	695	9.4	M 12 SW 10	40	0576 866...	0576 836...	1.5 mm
711.2	REP E W5 711.2	707.0 - 715.0	7.0	35	139	745	775	10.3	M 12 SW 10	40	0576 866...	0576 836...	1.5 mm
762.0	REP E W5 762.0	758.0 - 766.0	7.0	35	139	795	825	10.9	M 12 SW 10	40	0576 866...	0576 836...	1.5 mm
812.8	REP E W5 812.8	808.0 - 817.0	6.5	35	139	845	875	11.5	M 12 SW 10	40	0576 866...	0576 836...	1.5 mm
914.4	REP E W5 914.4	909.0 - 919.0	5.5	35	139	945	975	12.7	M 12 SW 10	45	0576 866...	0576 836...	1.5 mm
1016.0	REP E W5 1016.0	1013.0 - 1019.0	5.0	35	139	1050	1080	13.9	M 12 SW 10	45	0576 866...	0576 836...	1.5 mm
1117.5	REP E W5 1117.5	1114.0 - 1120.0	4.5	35	139	1150	1180	15.1	M 12 SW 10	50	0576 866...	0576 836...	1.5 mm
1219.2	REP E W5 1219.2	1216.0 - 1222.0	4.0	35	139	1250	1280	16.3	M 12 SW 10	50	0576 866...	0576 836...	1.5 mm

Coupling sizes >800 mm are in 2-parts design! Sizes > 1219.2 on request
... = Ø without decimals in mm



Refer to page 189.

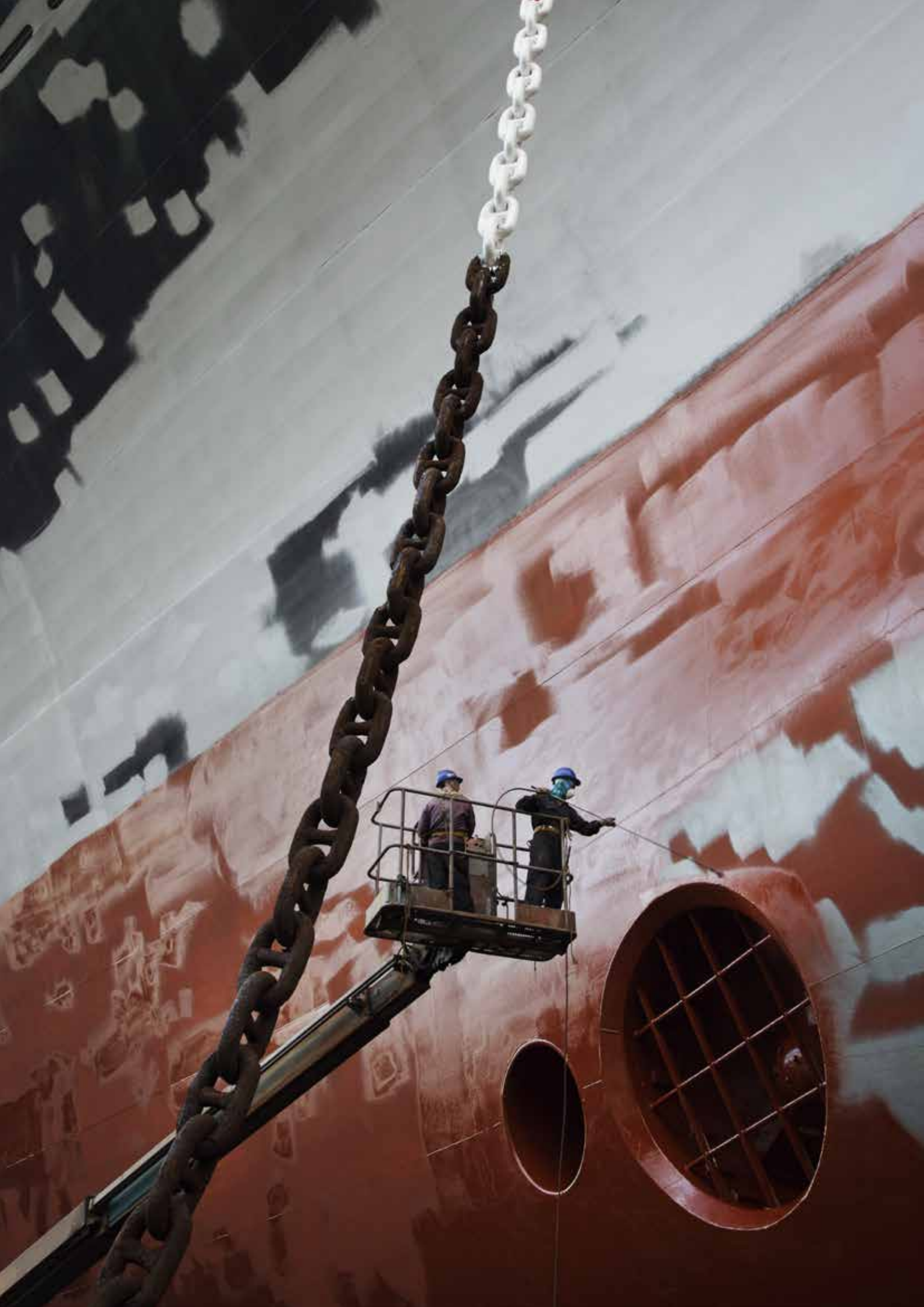

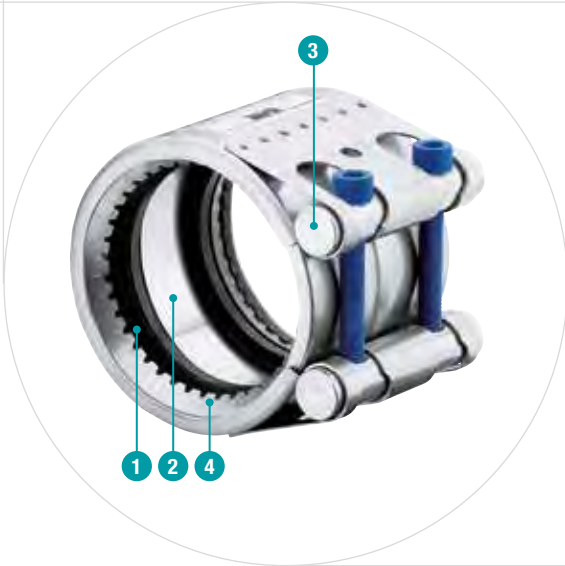

- 1 Double-lip sealing system
- 2 Standard strip insert
- 3 Heavy duty lock bars
- 4 Anchoring ring with conically stamped teeth

The strong pipe coupling

NORMACONNECT® GRIP/GRIP E axial restraint pipe couplings are used to connect metal pipes. The anchoring ring with conically stamped teeth indents into the pipe surface (steel, stainless steel or cast iron) and provides safe and strong axial restraint.

Owing to the special design, the coupling can withstand even high vibration loads.

Advantages at a glance

- Progressive locking effect ensures a trouble- and maintenance-free connection
- Reusable
- Shock resistant
- Space saving connector
- Withstand high vibration loads

Information

- Sizes: 26.9 mm- 711.2 mm
- Working pressure: 70.0 bar - 1.5 bar
- Material: AISI 304, AISI 316 Ti
- EPDM:
 - Sizes from 26.9 mm up to 168.3 mm: - 30 °C up to + 125 °C
 - Sizes > 180.0 mm: from - 20 °C up to + 80 °C
- NBR: from - 20 °C up to + 80 °C



Materials

W1	W2	W3	W4	W5
	x		x	x

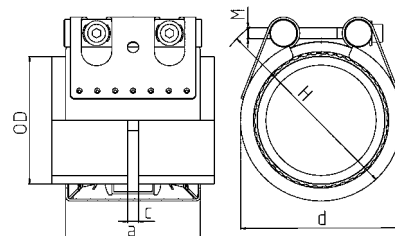
Technical data & Ordering information



Technical data & Ordering information

NORMACONNECT® FGR GRIP											
Ø (O.D.)	Designation	Clamping ranges	PN ¹	WP ²	C max	Dimensions			Weight	Hex socket locking bolts	
		O _{dmin} - O _{dmax}	 [bar]	 [bar]	(mm)	a (mm)	d (mm)	H (mm)	approx. (kg/pc.)	Thread	Tightening torque (Nm)
26.9	GRIP 26.9	26.4 - 27.5	16	70	3	67	50	70	0.39	M 8 SW 6	10
28.0	GRIP 28.0	27.5 - 28.5	16	70	3	67	50	70	0.39	M 8 SW 6	10
30.0	GRIP 30.0	29.5 - 30.6	16	70	3	67	50	70	0.39	M 8 SW 6	10
33.7	GRIP 33.7	33.0 - 34.3	16	60	3	67	55	75	0.40	M 8 SW 6	10
35.0	GRIP 35.0	34.5 - 35.6	16	60	8	63	55	75	0.55	M 8 SW 6	15
38.0	GRIP 38.0	37.5 - 38.6	16	60	8	63	60	80	0.55	M 8 SW 6	15
42.4	GRIP 42.4	41.7 - 43.0	16	50	8	63	65	85	0.56	M 8 SW 6	15
44.5	GRIP 44.5	44.0 - 45.1	16	50	8	63	65	85	0.57	M 8 SW 6	15
48.3	GRIP 48.3	47.6 - 50.5	16	50	8	63	70	90	0.59	M 8 SW 6	15
54.0	GRIP 54.0	53.3 - 54.6	16	50	17	78	75	95	0.77	M 8 SW 6	15
57.0	GRIP 57.0	56.3 - 57.7	16	50	17	78	80	100	0.77	M 8 SW 6	20
60.3	GRIP 60.3	59.5 - 61.0	16	40	17	78	85	105	0.78	M 8 SW 6	20
70.0	GRIP 70.0	69.0 - 71.0	16	40	25	98	90	110	1.38	M 10 SW 8	30
73.0	GRIP 73.0	72.1 - 73.8	16	40	25	98	95	115	1.40	M 10 SW 8	30
76.1	GRIP 76.1	75.2 - 77.0	16	35	25	98	100	120	1.40	M 10 SW 8	30
80.0	GRIP 80.0	79.0 - 80.8	16	35	25	98	100	120	1.44	M 10 SW 8	30
84.0	GRIP 84.0	83.0 - 85.0	16	35	25	98	105	125	1.46	M 10 SW 8	30
88.9	GRIP 88.9	87.0 - 89.9	16	35	25	98	110	130	1.48	M 10 SW 8	30
101.6	GRIP 101.6	100.4 - 102.8	16	35	25	98	125	145	1.62	M 10 SW 8	30
104.0	GRIP 104.0	102.8 - 106.1	16	35	25	98	125	145	1.63	M 10 SW 8	30
108.0	GRIP 108.0	106.8 - 109.2	16	35	25	98	130	150	1.66	M 10 SW 8	30
110.0	GRIP 110.0	108.8 - 111.4	16	35	25	98	130	150	1.71	M 10 SW 8	30
114.3	GRIP 114.3	113.0 - 115.5	16	35	25	98	135	155	1.71	M 10 SW 8	50
129.0	GRIP 129.0	127.6 - 131.1	16	32	35	115	155	185	3.06	M 12 SW 10	50
133.0	GRIP 133.0	131.5 - 134.4	16	32	35	115	160	190	3.16	M 12 SW 10	50
139.7	GRIP 139.7	138.1 - 141.6	16	32	35	115	165	195	3.27	M 12 SW 10	50
141.3	GRIP 141.3	139.6 - 142.8	16	32	35	115	170	200	3.27	M 12 SW 10	50
154.0	GRIP 154.0	152.3 - 156.1	16	32	35	115	180	210	3.39	M 12 SW 10	60
159.0	GRIP 159.0	157.3 - 160.7	16	32	35	115	185	215	3.51	M 12 SW 10	60
168.3	GRIP 168.3	166.5 - 170.1	16	32	35	115	195	225	3.57	M 12 SW 10	60
193.7	GRIP 193.7	192.0 - 196.0	16	32	35	142	225	255	6.8	M 16 SW 14	150
206.0	GRIP 206.0	202.0 - 208.0	16	32	35	142	240	270	7.0	M 16 SW 14	150
219.1	GRIP 219.1	216.0 - 221.0	16	32	35	142	250	280	7.3	M 16 SW 14	150
225.0	GRIP 225.0	222.0 - 227.0	13	26.5	35	142	255	285	7.4	M 16 SW 14	180
229.9	GRIP 229.9	228.0 - 232.0	13	26	35	142	260	290	7.5	M 16 SW 14	180
244.5	GRIP 244.5	242.0 - 247.0	12	24.5	35	142	275	305	7.7	M 16 SW 14	180
254.0	GRIP 254.0	250.0 - 256.0	11.5	22.5	35	142	285	315	7.9	M 16 SW 14	180
267.0	GRIP 267.0	264.0 - 269.0	11	22.5	35	142	300	330	8.2	M 16 SW 14	180
273.0	GRIP 273.0	270.0 - 275.0	11	22	35	142	305	335	8.3	M 16 SW 14	180
306.0	GRIP 306.0	302.0 - 308.0	9.5	19.5	35	142	340	370	8.9	M 16 SW 14	180
323.9	GRIP 323.9	320.0 - 327.0	6.5	13	35	142	355	385	9.2	M 16 SW 14	180
326.0	GRIP 326.0	322.0 - 329.0	6.5	13	35	142	360	390	9.3	M 16 SW 14	180
355.6	GRIP 355.6	352.0 - 359.0	6	12	35	142	390	420	9.8	M 16 SW 14	180
406.4	GRIP 406.4	402.0 - 410.0	4.5	9	35	142	440	470	10.8	M 16 SW 14	180
429.0	GRIP 429.0	426.0 - 431.0	4	8.5	35	142	460	490	11.3	M 16 SW 14	180
442.0	GRIP 442.0	439.0 - 444.0	4	8	35	142	475	505	11.5	M 16 SW 14	180
457.2	GRIP 457.2	454.0 - 459.0	4	8	35	142	490	520	11.8	M 16 SW 14	180
508.0	GRIP 508.0	505.0 - 510.0	2.5	5	35	142	540	570	12.7	M 16 SW 14	180
531.0	GRIP 531.0	528.0 - 534.0	2.5	5	35	142	565	595	13.2	M 16 SW 14	180
558.8	GRIP 558.8	556.0 - 562.0	2	4.5	35	142	590	620	13.7	M 16 SW 14	180
609.6	GRIP 609.6	606.0 - 613.0	1.5	3	35	142	640	670	14.7	M 16 SW 14	180
634.0	GRIP 634.0	631.0 - 637.0	1.5	3	35	142	665	695	15.1	M 16 SW 14	200
711.2	GRIP 711.2	707.0 - 715.0	1.5	2.5	35	142	745	775	16.6	M 16 Sw 14	200

PN¹ (Nominal Pressure) is the max. admissible working pressure in shipbuilding, based on a safety factor of ≥ 4 .

WP² is the max. working pressure in industrial applications, with a safety factor as per NORMA specification.

Technical data & Ordering information

NORMACONNECT® FGR GRIP										
Ø (O.D.)	Designation	W2 Product No.			W4 Product No.			W5 Product No.		
		NBR	EPDM	housing wall thckn.	NBR	EPDM	housing wall thckn.	NBR	EPDM	housing wall thckn.
26.9	GRIP 26.9	0057 8400 026	0578 9100 026	1.0 mm	0578 8500 026	0578 9200 026	1.0 mm	0578 8600 026	0578 9300 026	1.0 mm
28.0	GRIP 28.0	0578 8400 028	0578 9100 028	1.0 mm	0578 8500 028	0578 9200 028	1.0 mm	0578 8600 028	0578 9300 028	1.0 mm
30.0	GRIP 30.0	0578 8400 030	0578 9100 030	1.0 mm	0578 8500 030	0578 9200 030	1.0 mm	0578 8600 030	0578 9300 030	1.0 mm
33.7	GRIP 33.7	0578 8400 033	0578 9100 033	1.0 mm	0578 8500 033	0578 9200 033	1.0 mm	0578 8600 033	0578 9300 033	1.0 mm
35.0	GRIP 35.0	0578 8400 035	0578 9100 035	1.2 mm	0578 8500 035	0578 9200 035	1,2 mm	0578 8600 035	0578 9300 035	1,2 mm
38.0	GRIP 38.0	0578 8400 038	0578 9100 038	1.2 mm	0578 8500 038	0578 9200 038	1.2 mm	0578 8600 038	0578 9300 038	1.2 mm
42.4	GRIP 42.4	0578 8400 042	0578 9100 042	1.2 mm	0578 8500 042	0578 9200 042	1.2 mm	0578 8600 042	0578 9300 042	1.2 mm
44.5	GRIP 44,5	0578 8400 044	0578 9100 044	1.2 mm	0578 8500 044	0578 9200 044	1.2 mm	0578 8600 044	0578 9300 044	1.2 mm
48.3	GRIP 48.3	0578 8400 048	0578 9100 048	1.2 mm	0578 8500 048	0578 9200 048	1.2 mm	0578 8600 048	0578 9300 048	1.2 mm
54.0	GRIP 54.0	0578 8400 054	0578 9100 054	1.2 mm	0578 8500 054	0578 9200 054	1.2 mm	0578 8600 054	0578 9300 054	1.2 mm
57.0	GRIP 57.0	0578 8400 057	0578 9100 057	1.2 mm	0578 8500 057	0578 9200 057	1.2 mm	0578 8600 057	0578 9300 057	1.2 mm
60.3	GRIP 60.3	0578 8400 060	0578 9100 060	1.2 mm	0578 8500 060	0578 9200 060	1.2 mm	0578 8600 060	0578 9300 060	1.2 mm
70.0	GRIP 70.0	0578 8400 070	0578 9100 070	1.2 mm	0578 8500 070	0578 9200 070	1.5 mm	0578 8600 070	0578 9300 070	1.5 mm
73.0	GRIP 73.0	0578 8400 073	0578 9100 073	1.5 mm	0578 8500 073	0578 9200 073	1.5 mm	0578 8600 073	0578 9300 073	1.5 mm
76.1	GRIP 76.1	0578 8400 076	0578 9100 076	1.5 mm	0578 8500 076	0578 9200 076	1.5 mm	0578 8600 076	0578 9300 076	1.5 mm
80.0	GRIP 80.0	0578 8400 080	0578 9100 080	1.5 mm	0578 8500 080	0578 9200 080	1.5 mm	0578 8600 080	0578 9300 080	1.5 mm
84.0	GRIP 84.0	0578 8400 084	0578 9100 084	1.5 mm	0578 8500 084	0578 9200 084	1.5 mm	0578 8600 084	0578 9300 084	1.5 mm
88.9	GRIP 88.9	0578 8400 088	0578 9100 088	1.5 mm	0578 8500 088	0578 9200 088	1.5 mm	0578 8600 088	0578 9300 088	1.5 mm
101.6	GRIP 101.6	0578 8400 101	0578 9100 101	1.5 mm	0578 8500 101	0578 9200 101	1.5 mm	0578 8600 101	0578 9300 101	1.5 mm
104.0	GRIP 104.0	0578 8400 104	0578 9100 104	1.5 mm	0578 8500 104	0578 9200 104	1.5 mm	0578 8600 104	0578 9300 104	1.5 mm
108.0	GRIP 108.0	0578 8400 108	0578 9100 108	1.5 mm	0578 8500 108	0578 9200 108	1.5 mm	0578 8600 108	0578 9300 108	1.5 mm
110.0	GRIP 110.0	0578 8400 110	0578 9100 110	1.5 mm	0578 8500 110	0578 9200 110	1.5 mm	0578 8600 110	0578 9300 110	1.5 mm
114.3	GRIP 114.3	0578 8400 114	0578 9100 114	1.5 mm	0578 8500 114	0578 9200 114	1.5 mm	0578 8600 114	0578 9300 114	1.5 mm
129.0	GRIP 129.0	0578 8400 129	0578 9100 129	2.5 mm	0578 8500 129	0578 9200 129	2.5 mm	0578 8600 129	0578 9300 129	2.5 mm
133.0	GRIP 133.0	0578 8400 133	0578 9100 133	2.5 mm	0578 8500 133	0578 9200 133	2.5 mm	0578 8600 133	0578 9300 133	2.5 mm
139.7	GRIP 139.7	0578 8400 139	0578 9100 139	2.5 mm	0578 8500 139	0578 9200 139	2.5 mm	0578 8600 139	0578 9300 139	2.5 mm
141.3	GRIP 141.3	0578 8400 141	0578 9100 141	2.5 mm	0578 8500 141	0578 9200 141	2.5 mm	0578 8600 141	0578 9300 141	2.5 mm
154.0	GRIP 154.0	0578 8400 154	0578 9100 154	2.5 mm	0578 8500 154	0578 9200 154	2.5 mm	0578 8600 154	0578 9300 154	2.5 mm
159.0	GRIP 159.0	0578 8400 159	0578 9100 159	2.5 mm	0578 8500 159	0578 9200 159	2.5 mm	0578 8600 159	0578 9300 159	2.5 mm
168.3	GRIP 168.3	0578 8400 168	0578 9100 168	2.5 mm	0578 8500 168	0578 9200 168	2.5 mm	0578 8600 168	0578 9300 168	2.5 mm
193.7	GRIP 193.7	0577 840. ...	0577 810. ...	3.0 mm	0577 850. ...	0577 820. ...	3.0 mm	0577 860. ...	0577 830. ...	3.0 mm
206.0	GRIP 206.0	0577 840. ...	0577 810. ...	3.0 mm	0577 850. ...	0577 820. ...	3.0 mm	0577 860. ...	0577 830. ...	3.0 mm
219.1	GRIP 219.1	0577 840. ...	0577 810. ...	3.0 mm	0577 850. ...	0577 820. ...	3.0 mm	0577 860. ...	0577 830. ...	3.0 mm
225.0	GRIP 225.0	0577 840. ...	0577 810. ...	3.0 mm	0577 850. ...	0577 820. ...	3.0 mm	0577 860. ...	0577 830. ...	3.0 mm
229.9	GRIP 229.9	0577 840. ...	0577 810. ...	3.0 mm	0577 850. ...	0577 820. ...	3.0 mm	0577 860. ...	0577 830. ...	3.0 mm
244.5	GRIP 244.5	0577 840. ...	0577 810. ...	3.0 mm	0577 850. ...	0577 820. ...	3.0 mm	0577 860. ...	0577 830. ...	3.0 mm
254.0	GRIP 254.0	0577 840. ...	0577 810. ...	3.0 mm	0577 850. ...	0577 820. ...	3.0 mm	0577 860. ...	0577 830. ...	3.0 mm
267.0	GRIP 267.0	0577 840. ...	0577 810. ...	3.0 mm	0577 850. ...	0577 820. ...	3.0 mm	0577 860. ...	0577 830. ...	3.0 mm
273.0	GRIP 273.0	0577 840. ...	0577 810. ...	3.0 mm	0577 850. ...	0577 820. ...	3.0 mm	0577 860. ...	0577 830. ...	3.0 mm
306.0	GRIP 306.0	0577 840. ...	0577 810. ...	3.0 mm	0577 850. ...	0577 820. ...	3.0 mm	0577 860. ...	0577 830. ...	3.0 mm
323.9	GRIP 323.9	0577 840. ...	0577 810. ...	3.0 mm	0577 850. ...	0577 820. ...	3.0 mm	0577 860. ...	0577 830. ...	3.0 mm
326.0	GRIP 326.0	0577 840. ...	0577 810. ...	3.0 mm	0577 850. ...	0577 820. ...	3.0 mm	0577 860. ...	0577 830. ...	3.0 mm
355.6	GRIP 355.6	0577 840. ...	0577 810. ...	3.0 mm	0577 850. ...	0577 820. ...	3.0 mm	0577 860. ...	0577 830. ...	3.0 mm
406.4	GRIP 406.4	0577 840. ...	0577 810. ...	3.0 mm	0577 850. ...	0577 820. ...	3.0 mm	0577 860. ...	0577 830. ...	3.0 mm
429.0	GRIP 429.0	0577 840. ...	0577 810. ...	3.0 mm	0577 850. ...	0577 820. ...	3.0 mm	0577 860. ...	0577 830. ...	3.0 mm
442.0	GRIP 442.0	0577 840. ...	0577 810. ...	3.0 mm	0577 850. ...	0577 820. ...	3.0 mm	0577 860. ...	0577 830. ...	3.0 mm
457.2	GRIP 457.2	0577 840. ...	0577 810. ...	3.0 mm	0577 850. ...	0577 820. ...	3.0 mm	0577 860. ...	0577 830. ...	3.0 mm
508.0	GRIP 508.0	0577 840. ...	0577 810. ...	3.0 mm	0577 850. ...	0577 820. ...	3.0 mm	0577 860. ...	0577 830. ...	3.0 mm
531.0	GRIP 531.0	0577 840. ...	0577 810. ...	3.0 mm	0577 850. ...	0577 820. ...	3.0 mm	0577 860. ...	0577 830. ...	3.0 mm
558.8	GRIP 558.8	0577 840. ...	0577 810. ...	3.0 mm	0577 850. ...	0577 820. ...	3.0 mm	0577 860. ...	0577 830. ...	3.0 mm
609.6	GRIP 609.6	0577 840. ...	0577 810. ...	3.0 mm	0577 850. ...	0577 820. ...	3.0 mm	0577 860. ...	0577 830. ...	3.0 mm
634.0	GRIP 634.0	0577 840. ...	0577 810. ...	3.0 mm	0577 850. ...	0577 820. ...	3.0 mm	0577 860. ...	0577 830. ...	3.0 mm
711.2	GRIP 711.2	0577 840. ...	0577 810. ...	3.0 mm	0577 850. ...	0577 820. ...	3.0 mm	0577 860. ...	0577 830. ...	3.0 mm

... = Ø without decimals in mm

GRIP E



NORMACONNECT® GRIP E axial restraint pipe couplings are used to connect metal pipes.

Advantages at a glance

- Hollow trunnions for low pressure applications from diameter 168.3.

Materials

- W2, W4, W5

NORMACONNECT® FGR GRIP E

Ø (O.D.)	Designation	Clamping ranges	PN ¹	WP ²	C max	Dimensions			Weight	Hex socket locking bolts	
		Odmin - Odmax	[bar]	[bar]	(mm)	a (mm)	d (mm)	H (mm)	approx. (kg/pc.)	Thread	Tightening torque (Nm)
26.9	GRIP E 26.9	26.4 - 27.5	16	70	3	67	50	70	0.32	M 8 SW 6	10
28.0	GRIP E 28.0	27.5 - 28.5	16	70	3	67	50	70	0.32	M 8 SW 6	10
30.0	GRIP E 30.0	29.5 - 30.6	16	70	3	67	50	70	0.32	M 8 SW 6	10
33.7	GRIP E 33.7	33.0 - 34.3	16	60	3	67	55	75	0.33	M 8 SW 6	10
35.0	GRIP E 35.0	34.5 - 35.6	16	60	8	63	55	75	0.45	M 8 SW 6	15
38.0	GRIP E 38.0	37.5 - 38.6	16	60	8	63	60	80	0.45	M 8 SW 6	15
42.4	GRIP E 42.4	41.7 - 43.0	16	50	8	63	65	85	0.46	M 8 SW 6	15
44.5	GRIP E 44.5	44.0 - 45.1	16	50	8	63	65	85	0.47	M 8 SW 6	15
48.3	GRIP E 48.3	47.6 - 50.5	16	50	8	63	70	90	0.48	M 8 SW 6	15
54.0	GRIP E 54.0	53.3 - 54.6	16	50	17	78	75	95	0.62	M 8 SW 6	15
57.0	GRIP E 57.0	56.3 - 57.7	16	50	17	78	80	100	0.63	M 8 SW 6	20
60.3	GRIP E 60.3	59.5 - 61.0	16	40	17	78	85	105	0.64	M 8 SW 6	20
70.0	GRIP E 70.0	69.0 - 71.0	16	40	25	98	90	110	1.21	M 10 SW 8	30
73.0	GRIP E 73.0	72.1 - 73.8	16	40	25	98	95	115	1.23	M 10 SW 8	30
76.1	GRIP E 76.1	75.2 - 77.0	16	35	25	98	100	120	1.23	M 10 SW 8	30
80.0	GRIP E 80.0	79.0 - 80.8	16	35	25	98	100	120	1.27	M 10 SW 8	30
84.0	GRIP E 84.0	83.0 - 85.0	16	35	25	98	105	125	1.29	M 10 SW 8	30
88.9	GRIP E 88.9	87.0 - 89.9	16	35	25	98	110	130	1.31	M 10 SW 8	30
101.6	GRIP E 101.6	100.4 - 102.8	16	35	25	98	125	145	1.45	M 10 SW 8	30
104.0	GRIP E 104.0	102.8 - 106.1	16	35	25	98	125	145	1.46	M 10 SW 8	30
108.0	GRIP E 108.0	106.8 - 109.2	16	35	25	98	130	150	1.49	M 10 SW 8	30
110.0	GRIP E 110.0	108.8 - 111.4	16	35	25	98	130	150	1.54	M 10 SW 8	30
114.3	GRIP E 114.3	113.0 - 115.5	16	35	25	98	135	155	1.54	M 10 SW 8	50
129.0	GRIP E 129.0	127.6 - 131.1	16	32	35	115	155	185	2.83	M 12 SW 10	50
133.0	GRIP E 133.0	131.5 - 134.4	16	32	35	115	160	190	2.93	M 12 SW 10	50
139.7	GRIP E 139.7	138.1 - 141.6	16	32	35	115	165	195	3.04	M 12 SW 10	50
141.3	GRIP E 141.3	139.6 - 142.8	16	32	35	115	170	200	3.04	M 12 SW 10	50
154.0	GRIP E 154.0	152.3 - 156.1	16	32	35	115	180	210	3.17	M 12 SW 10	60
159.0	GRIP E 159.0	157.3 - 160.7	16	32	35	115	185	215	3.28	M 12 SW 10	60
168.3	GRIP E 168.3	166.5 - 170.1	16	32	35	115	195	225	3.35	M 12 SW 10	60
193.7	GRIP E 193.7	192.0 - 196.0	10	20	35	141	225	255	6.2	M 16 SW 14	100
206.0	GRIP E 206.0	202.0 - 208.0	10	20	35	141	240	270	6.5	M 16 SW 14	100
219.1	GRIP E 219.1	216.0 - 221.0	10	20	35	141	250	280	6.7	M 16 SW 14	100
225.0	GRIP E 225.0	222.0 - 227.0	10	16	35	140	255	285	6.2	M 16 SW 14	100
229.9	GRIP E 229.9	228.0 - 232.0	5.5	16	35	140	260	290	6.3	M 16 SW 14	100
244.5	GRIP E 244.5	242.0 - 247.0	5.5	15	35	140	275	305	6.5	M 16 SW 14	100
254.0	GRIP E 254.0	250.0 - 256.0	5.5	14	35	140	285	315	6.6	M 16 SW 14	100
267.0	GRIP E 267.0	264.0 - 269.0	5.5	13.5	35	140	300	330	6.8	M 16 SW 14	100
273.0	GRIP E 273.0	270.0 - 275.0	5.5	13	35	140	305	335	6.9	M 16 SW 14	100
306.0	GRIP E 306.0	302.0 - 308.0	5.5	10.5	35	140	340	370	7.4	M 16 SW 14	120
323.9	GRIP E 323.9	320.0 - 327.0	3	9.5	35	140	355	385	7.7	M 16 SW 14	120
326.0	GRIP E 326.0	322.0 - 329.0	3	9.5	35	140	360	390	7.7	M 16 SW 14	120
355.6	GRIP E 355.6	352.0 - 359.0	2.7	8.5	35	140	390	420	8.2	M 16 SW 14	120
406.4	GRIP E 406.4	402.0 - 410.0	2.5	7.0	35	140	440	470	8.9	M 16 SW 14	120
429.0	GRIP E 429.0	426.0 - 431.0	2.5	6.5	35	140	460	490	9.3	M 16 SW 14	120
442.0	GRIP E 442.0	439.0 - 444.0	2.5	6.5	35	140	475	505	9.5	M 16 SW 14	140
457.2	GRIP E 457.2	454.0 - 459.0	2.5	6.0	35	140	490	520	9.7	M 16 SW 14	140
508.0	GRIP E 508.0	505.0 - 510.0	2	4.0	35	140	540	570	10.5	M 16 SW 14	140
531.0	GRIP E 531.0	528.0 - 534.0	1.5	4.0	35	140	565	595	10.8	M 16 SW 14	140
558.8	GRIP E 558.8	556.0 - 562.0	1.5	3.5	35	140	590	620	11.3	M 16 SW 14	140
609.6	GRIP E 609.6	606.0 - 613.0	1	2.0	35	140	640	670	12.0	M 16 SW 14	140

PN¹ (Nominal Pressure) is the max. admissible working pressure in shipbuilding, based on a safety factor of ≥ 4.
 WP² is the max. working pressure in industrial applications, with a safety factor as per NORMA specification.

Technical data & Ordering information

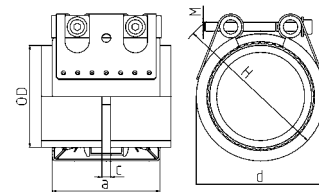

NORMACONNECT® FGR GRIP E										
Ø (O.D.)	Designation	W2 Product No.			W4 Product No.			W5 Product No.		
		NBR	EPDM	housing wall thic kn.	NBR	EPDM	housing wall thic kn.	NBR	EPDM	housing wall thic kn.
26.9	GRIP E 26.9	0579 8400 026	0579 9100 026	1.0 mm	0579 8500 026	0579 9200 026	1.0 mm	0579 8600 026	0579 9300 026	1.0 mm
28.0	GRIP E 28.0	0579 8400 028	0579 9100 028	1.0 mm	0579 8500 028	0579 9200 028	1.0 mm	0579 8600 028	0579 9300 028	1.0 mm
30.0	GRIP E 30.0	0579 8400 030	0579 9100 030	1.0 mm	0579 8500 030	0579 9200 030	1.0 mm	0579 8600 030	0579 9300 030	1.0 mm
33.7	GRIP E 33.7	0579 8400 033	0579 9100 033	1.0 mm	0579 8500 033	0579 9200 033	1.0 mm	0579 8600 033	0579 9300 033	1.0 mm
35.0	GRIP E 35.0	0579 8400 035	0579 9100 035	1.2 mm	0579 8500 035	0579 9200 035	1.2 mm	0579 8600 035	0579 9300 035	1.2 mm
38.0	GRIP E 38.0	0579 8400 038	0579 9100 038	1.2 mm	0579 8500 038	0579 9200 038	1.2 mm	0579 8600 038	0579 9300 038	1.2 mm
42.4	GRIP E 42.4	0579 8400 042	0579 9100 042	1.2 mm	0579 8500 042	0579 9200 042	1.2 mm	0579 8600 042	0579 9300 042	1.2 mm
44.5	GRIP E 44.5	0579 8400 044	0579 9100 044	1.2 mm	0579 8500 044	0579 9200 044	1.2 mm	0579 8600 044	0579 9300 044	1.2 mm
48.3	GRIP E 48.3	0579 8400 048	0579 9100 048	1.2 mm	0579 8500 048	0579 9200 048	1.2 mm	0579 8600 048	0579 9300 048	1.2 mm
54.0	GRIP E 54.0	0579 8400 054	0579 9100 054	1.2 mm	0579 8500 054	0579 9200 054	1.2 mm	0579 8600 054	0579 9300 054	1.2 mm
57.0	GRIP E 57.0	0579 8400 057	0579 9100 057	1.2 mm	0579 8500 057	0579 9200 057	1.2 mm	0579 8600 057	0579 9300 057	1.2 mm
60.3	GRIP E 60.3	0579 8400 060	0579 9100 060	1.2 mm	0579 8500 060	0579 9200 060	1.2 mm	0579 8600 060	0579 9300 060	1.2 mm
70.0	GRIP E 70.0	0579 8400 070	0579 9100 070	1.5 mm	0579 8500 070	0579 9200 070	1.5 mm	0579 8600 070	0579 9300 070	1.5 mm
73.0	GRIP E 73.0	0579 8400 073	0579 9100 073	1.5 mm	0579 8500 073	0579 9200 073	1.5 mm	0579 8600 073	0579 9300 073	1.5 mm
76.1	GRIP E 76.1	0579 8400 076	0579 9100 076	1.5 mm	0579 8500 076	0579 9200 076	1.5 mm	0579 8600 076	0579 9300 076	1.5 mm
80.0	GRIP E 80.0	0579 8400 080	0579 9100 080	1.5 mm	0579 8500 080	0579 9200 080	1.5 mm	0579 8600 080	0579 9300 080	1.5 mm
84.0	GRIP E 84.0	0579 8400 084	0579 9100 084	1.5 mm	0579 8500 084	0579 9200 084	1.5 mm	0579 8600 084	0579 9300 084	1.5 mm
88.9	GRIP E 88.9	0579 8400 088	0579 9100 088	1.5 mm	0579 8500 088	0579 9200 088	1.5 mm	0579 8600 088	0579 9300 088	1.5 mm
101.6	GRIP E 101.6	0579 8400 101	0579 9100 101	1.5 mm	0579 8500 101	0579 9200 101	1.5 mm	0579 8600 101	0579 9300 101	1.5 mm
104.0	GRIP E 104.0	0579 8400 104	0579 9100 104	1.5 mm	0579 8500 104	0579 9200 104	1.5 mm	0579 8600 104	0579 9300 104	1.5 mm
108.0	GRIP E 108.0	0579 8400 108	0579 9100 108	1.5 mm	0579 8500 108	0579 9200 108	1.5 mm	0579 8600 108	0579 9300 108	1.5 mm
110.0	GRIP E 110.0	0579 8400 110	0579 9100 110	1.5 mm	0579 8500 110	0579 9200 110	1.5 mm	0579 8600 110	0579 9300 110	1.5 mm
114.3	GRIP E 114.3	0579 8400 114	0579 9100 114	1.5 mm	0579 8500 114	0579 9200 114	1.5 mm	0579 8600 114	0579 9300 114	1.5 mm
129.0	GRIP E 129.0	0579 8400 129	0579 9100 129	2.5 mm	0579 8500 129	0579 9200 129	2.5 mm	0579 8600 129	0579 9300 129	2.5 mm
133.0	GRIP E 133.0	0579 8400 133	0579 9100 133	2.5 mm	0579 8500 133	0579 9200 133	2.5 mm	0579 8600 133	0579 9300 133	2.5 mm
139.7	GRIP E 139.7	0579 8400 139	0579 9100 139	2.5 mm	0579 8500 139	0579 9200 139	2.5 mm	0579 8600 139	0579 9300 139	2.5 mm
141.3	GRIP E 141.3	0579 8400 141	0579 9100 141	2.5 mm	0579 8500 141	0579 9200 141	2.5 mm	0579 8600 141	0579 9300 141	2.5 mm
154.0	GRIP E 154.0	0579 8400 154	0579 9100 154	2.5 mm	0579 8500 154	0579 9200 154	2.5 mm	0579 8600 154	0579 9300 154	2.5 mm
159.0	GRIP E 159.0	0579 8400 159	0579 9100 159	2.5 mm	0579 8500 159	0579 9200 159	2.5 mm	0579 8600 159	0579 9300 159	2.5 mm
168.3	GRIP E 168.3	0579 8400 168	0579 9100 168	2.5 mm	0579 8500 168	0579 9200 168	2.5 mm	0579 8600 168	0579 9300 168	2.5 mm
193.7	GRIP E 193.7	0574 840. ...	0574 810. ...	2.5 mm	0574 850. ...	0574 820. ...	2.5 mm	0574 860. ...	0574 830. ...	2.5 mm
206.0	GRIP E 206.0	0574 840. ...	0574 810. ...	2.5 mm	0574 850. ...	0574 820. ...	2.5 mm	0574 860. ...	0574 830. ...	2.5 mm
219.1	GRIP E 219.1	0574 840. ...	0574 810. ...	2.0 mm	0574 850. ...	0574 820. ...	2.5 mm	0574 860. ...	0574 830. ...	2.5 mm
225.0	GRIP E 225.0	0574 840. ...	0574 810. ...	2.0 mm	0574 850. ...	0574 820. ...	2.5 mm	0574 860. ...	0574 830. ...	2.5 mm
229.9	GRIP E 229.9	0574 840. ...	0574 810. ...	2.0 mm	0574 850. ...	0574 820. ...	2.5 mm	0574 860. ...	0574 830. ...	2.5 mm
244.5	GRIP E 244.5	0574 840. ...	0574 810. ...	2.0 mm	0574 850. ...	0574 820. ...	2.5 mm	0574 860. ...	0574 830. ...	2.5 mm
254.0	GRIP E 254.0	0574 840. ...	0574 810. ...	2.0 mm	0574 850. ...	0574 820. ...	2.5 mm	0574 860. ...	0574 830. ...	2.5 mm
267.0	GRIP E 267.0	0574 840. ...	0574 810. ...	2.0 mm	0574 850. ...	0574 820. ...	2.5 mm	0574 860. ...	0574 830. ...	2.5 mm
273.0	GRIP E 273.0	0574 840. ...	0574 810. ...	2.0 mm	0574 850. ...	0574 820. ...	2.5 mm	0574 860. ...	0574 830. ...	2.5 mm
306.0	GRIP E 306.0	0574 840. ...	0574 810. ...	2.0 mm	0574 850. ...	0574 820. ...	2.5 mm	0574 860. ...	0574 830. ...	2.5 mm
323.9	GRIP E 323.9	0574 840. ...	0574 810. ...	2.0 mm	0574 850. ...	0574 820. ...	2.5 mm	0574 860. ...	0574 830. ...	2.5 mm
326.0	GRIP E 326.0	0574 840. ...	0574 810. ...	2.0 mm	0574 850. ...	0574 820. ...	2.5 mm	0574 860. ...	0574 830. ...	2.5 mm
355.6	GRIP E 355.6	0574 840. ...	0574 810. ...	2.0 mm	0574 850. ...	0574 820. ...	2.5 mm	0574 860. ...	0574 830. ...	2.5 mm
406.4	GRIP E 406.4	0574 840. ...	0574 810. ...	2.0 mm	0574 850. ...	0574 820. ...	2.5 mm	0574 860. ...	0574 830. ...	2.5 mm
429.0	GRIP E 429.0	0574 840. ...	0574 810. ...	2.0 mm	0574 850. ...	0574 820. ...	2.5 mm	0574 860. ...	0574 830. ...	2.5 mm
442.0	GRIP E 442.0	0574 840. ...	0574 810. ...	2.0 mm	0574 850. ...	0574 820. ...	2.5 mm	0574 860. ...	0574 830. ...	2.5 mm
457.2	GRIP E 457.2	0574 840. ...	0574 810. ...	2.0 mm	0574 850. ...	0574 820. ...	2.5 mm	0574 860. ...	0574 830. ...	2.5 mm
508.0	GRIP E 508.0	0574 840. ...	0574 810. ...	2.0 mm	0574 850. ...	0574 820. ...	2.5 mm	0574 860. ...	0574 830. ...	2.5 mm
531.0	GRIP E 531.0	0574 840. ...	0574 810. ...	2.0 mm	0574 850. ...	0574 820. ...	2.5 mm	0574 860. ...	0574 830. ...	2.5 mm
558.8	GRIP E 558.8	0574 840. ...	0574 810. ...	2.0 mm	0574 850. ...	0574 820. ...	2.5 mm	0574 860. ...	0574 830. ...	2.5 mm
609.6	GRIP E 609.6	0574 840. ...	0574 810. ...	2.0 mm	0574 850. ...	0574 820. ...	2.5 mm	0574 860. ...	0574 830. ...	2.5 mm

... = Ø without decimals in mm

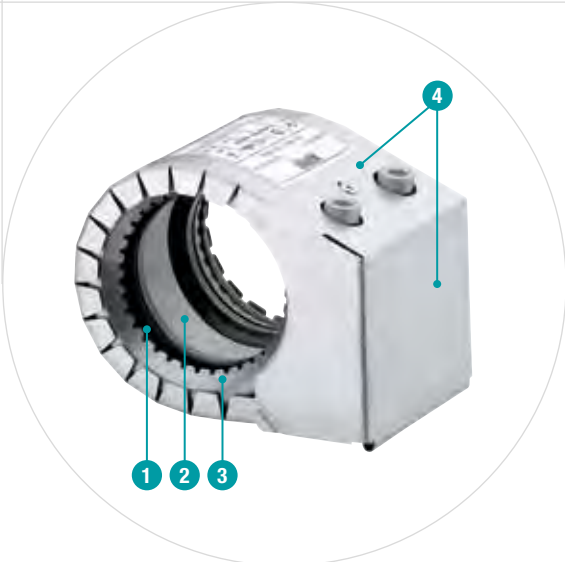

- 1 Double-lip sealing system
- 2 Standard strip insert
- 3 Conically stamped anchoring ring
- 4 Flame protection housing

The fire resistant coupling

NORMACONNECT® GRIP E-FP pipe couplings with integrated flame protection are used with applications in the marine sector (civil and military) as well as in sprinkler systems. For this purpose the GRIP E type has been equipped with an additional housing made from stainless steel

plus a fire-resistant lining which can resist temperatures of up to 850°C. The pipe coupling meets the newest VdS directives, IACS P2.11 and ISO 19921/22. Pressures and dimensions on request.

Advantages at a glance

- Dampens absorbing vibrations, pressure surges
- Weight saving
- Tension free
- Ready to install



Information

- Sizes: 40.0 mm - 406.0 mm
- Working pressure: 16.0 - 6.0 bar
- Material: AISI 304, AISI 316 Ti
- EPDM:
 - Sizes from 26.9 mm up to 168.3 mm: - 30 °C up to + 125 °C
 - Sizes > 180.0 mm: from - 20 °C up to + 80 °C
- NBR: from - 20 °C up to + 80 °C

Materials

W1	W2	W3	W4	W5
				x

Technical data & Ordering information

NORMACONNECT® FGR GRIP E-FP														
Ø (O.D.)	Designation	Clamping ranges	PN¹ (MAWP¹ from diame- ter 180)	WP² 	C max	Dimensions			Weight approx. (kg/pc.)	Hex socket locking bolts		W5 Product No.		
						Øadmin - Ødmax				a (mm)	d (mm)	H (mm)	Thread	Tightening torque (Nm)
26.9	GRIP E FP 26.9	26.4 - 27.5	16	70	3	67	60	110	0.42	M 8 SW 6	10	0579 8670 026	0579 9370 026	1.0 mm
28.0	GRIP E FP 28.0	27.5 - 28.5	16	70	3	67	60	110	0.42	M 8 SW 6	10	0579 8670 028	0579 9370 028	1.0 mm
30.0	GRIP E FP 30.0	29.5 - 30.6	16	70	3	67	60	110	0.42	M 8 SW 6	10	0579 8670 030	0579 9370 030	1.0 mm
33.7*	GRIP E FP 33.7	33.0 - 34.3	16	60	3	67	65	115	0.43	M 8 SW 6	10	0579 8670 033	0579 9370 033	1.0 mm
35.0	GRIP E FP 35.0	34.5 - 35.6	16	60	8	75	65	115	0.58	M 8 SW 6	15	0579 8670 035	0579 9370 035	1.2 mm
38.0	GRIP E FP 38.0	37.5 - 38.6	16	60	8	75	70	120	0.58	M 8 SW 6	15	0579 8670 038	0579 9370 038	1.2 mm
42.4*	GRIP E FP 42.4	41.7 - 43.0	16	50	8	75	75	125	0.59	M 8 SW 6	15	0579 8670 042	0579 9370 042	1.2 mm
44.5	GRIP E FP 44.5	44.0 - 45.1	16	50	8	75	75	125	0.60	M 8 SW 6	15	0579 8670 044	0579 9370 044	1.2 mm
48.3*	GRIP E FP 48.3	47.6 - 50.5	16	50	8	75	80	130	0.61	M 8 SW 6	15	0579 8670 048	0579 9370 048	1.2 mm
54.0	GRIP E FP 54.0	53.3 - 54.6	16	50	17	90	85	135	0.92	M 8 SW 6	15	0579 8670 054	0579 9370 054	1.2 mm
57.0	GRIP E FP 57.0	56.3 - 57.7	16	50	17	90	90	140	0.93	M 8 SW 6	20	0579 8670 057	0579 9370 057	1.2 mm
60.3*	GRIP E FP 60.3	59.5 - 61.0	16	40	17	90	95	145	0.94	M 8 SW 6	20	0579 8670 060	0579 9370 060	1.2 mm
73.0	GRIP E FP 73.0	72.1 - 73.8	16	40	17	90	95	145	0.94	M 10 SW 8	30	0579 8670 073	0579 9370 073	1.5 mm
76.1*	GRIP E FP 76.1	75.2 - 77.0	16	35	25	110	105	155	1.49	M 10 SW 8	30	0579 8670 076	0579 9370 076	1.5 mm
84.0	GRIP E FP 84.0	83.0 - 85.0	16	35	25	110	110	160	1.49	M 10 SW 8	30	0579 8670 084	0579 9370 084	1.5 mm
88.9*	GRIP E FP 88.9	87.0 - 89.9	16	35	25	110	115	165	1.56	M 10 SW 8	30	0579 8670 088	0579 9370 088	1.5 mm
101.6	GRIP E FP 101.6	100.4 - 102.8	16	35	25	110	120	170	1.59	M 10 SW 8	30	0579 8670 101	0579 9370 101	1.5 mm
104.0	GRIP E FP 104.0	102.8 - 106.1	16	35	25	110	135	185	1.75	M 10 SW 8	30	0579 8670 104	0579 9370 104	1.5 mm
108.0	GRIP E FP 108.0	106.8 - 109.2	16	35	25	110	135	185	1.76	M 10 SW 8	30	0579 8670 108	0579 9370 108	1.5 mm
110.0	GRIP E FP 110.0	108.8 - 111.4	16	35	25	110	140	190	1.79	M 10 SW 8	30	0579 8670 110	0579 9370 110	1.5 mm
114.3*	GRIP E FP 114.3	113.0 - 115.5	16	35	25	110	145	195	1.89	M 10 SW 8	40	0579 8670 114	0579 9370 114	1.5 mm
129.0	GRIP E FP 129.0	127.6 - 131.1	16	32	35	125	165	215	3.25	M 12 SW 10	50	0579 8670 129	0579 9370 129	2.5 mm
133.0	GRIP E FP 133.0	131.5 - 134.4	16	32	35	125	170	220	3.36	M 12 SW 10	50	0579 8670 133	0579 9370 133	2.5 mm
139.7*	GRIP E FP 139.7	138.1 - 141.6	16	32	35	125	175	225	3.48	M 12 SW 10	50	0579 8670 139	0579 9370 139	2.5 mm
141.3	GRIP E FP 141.3	139.6 - 142.8	16	32	35	125	180	230	3.48	M 12 SW 10	50	0579 8670 141	0579 9370 141	2.5 mm
154.0	GRIP E FP 154.0	152.3 - 156.1	16	32	35	125	190	240	3.63	M 12 SW 10	60	0579 8670 154	0579 9370 154	2.5 mm
159.0	GRIP E FP 159.0	157.3 - 160.7	16	32	35	125	195	245	3.75	M 12 SW 10	60	0579 8670 159	0579 9370 159	2.5 mm
168.3	GRIP E FP 168.3	166.5 - 170.1	16	32	35	125	205	255	3.83	M 12 SW 10	60	0579 8670 168	0579 9370 168	2.5 mm
193.7	GRIP E FP 193.7	192.0 - 196.0	10	20	35	125	235	285	6.9	M 16 SW 14	100	0579 8670 193	0579 9370 193	2.5 mm
206.0	GRIP E FP 206.0	202.0 - 208.0	10	20	35	125	250	300	7.2	M 16 SW 14	100	0579 8670 206	0579 9370 206	2.5 mm
219.1	GRIP E FP 219.1	216.0 - 221.0	10	20	35	125	260	310	7.4	M 16 SW 14	100	0574 8670 219	0574 8370 219	3.0 mm
225.0	GRIP E FP 225.0	222.0 - 227.0	10	16	35	155	265	315	7.0	M 16 SW 14	100	0579 8670 225	0579 9370 225	3.0 mm
229.9	GRIP E FP 229.9	228.0 - 232.0	5.5	16	35	155	270	320	7.0	M 16 SW 14	100	0579 8670 229	0579 9370 229	3.0 mm
244.5	GRIP E FP 244.5	242.0 - 247.0	5.5	15	35	155	285	335	7.3	M 16 SW 14	100	0579 8670 244	0579 9370 244	3.0 mm
254.5	GRIP E FP 254.5	250.0 - 256.0	5.5	14	35	155	285	335	7.5	M 16 SW 14	100	0579 8670 254	0579 9370 254	3.0 mm
267.0	GRIP E FP 267.0	264.0 - 269.0	5.5	13.5	35	155	310	360	7.7	M 16 SW 14	100	0579 8670 267	0579 9370 267	3.0 mm
273.0	GRIP E FP 273.0	270.0 - 275.0	5.5	13	35	155	315	365	7.8	M 16 SW 14	100	0579 8670 273	0579 9370 273	3.0 mm
306.0	GRIP E FP 306.0	302.0 - 308.0	5.5	10.5	35	155	350	400	8.4	M 16 SW 14	120	0579 8670 306	0579 9370 306	3.0 mm
323.9	GRIP E FP 323.9	320.0 - 327.0	3	9.5	35	155	365	415	8.7	M 16 SW 14	120	0579 8670 323	0579 9370 323	3.0 mm
326.0	GRIP E FP 326.0	322.0 - 329.0	3	9.5	35	155	370	420	8.8	M 16 SW 14	120	0579 8670 326	0579 9370 326	3.0 mm
355.6	GRIP E FP 355.6	352.0 - 359.0	2.7	8.5	35	155	400	450	9.3	M 16 SW 14	120	0579 8670 355	0579 9370 355	3.0 mm
406.4	GRIP E FP 406.4	402.0 - 410.0	2.5	7.0	35	155	450	500	10.2	M 16 SW 14	120	0579 8670 406	0579 9370 406	3.0 mm
419.0	GRIP E FP 419.0	415.0 - 422.0	2.5	6.5	35	155	460	510	10.4	M 16 SW 14	180	0579 8670 419	0579 9370 419	3.0 mm

PN¹ (Nominal Pressure) is the max. admissible working pressure in shipbuilding, based on a safety factor of ≥ 4.

MAWP¹ (Maximum Allowable Working Pressure) is the max. admissible working pressure in shipbuilding, based on a safety factor of ≥ 4.

WP² is the max. working pressure in industrial applications, with a safety factor as per NORMA specification.

*VdS approved

... = Ø without decimals in mm

NORMACONNECT®



- 1 **Metal housing made from AISI 316 Ti**
- 2 **Environmentally-friendly – No use of chemicals**
- 3 **Shoulders of the coupling are flame protected**



Double-locked safeguards prevent dismantling

RFP for application at shipbuilding

The NEW NORMACONNECT® RFP is a retrofittable flame protection housing that has been specially designed for use with all NORMACONNECT® FLEX, GRIP and REP pipe couplings. Its low weight and straightforward design allows quick, easy assembly without any tools. The built-in flame resistant mineral fiber mat provides a premium level of flame protection.

The new Retrofit Flame Protection (RFP) housing has been extensively tested and is approved by Germanischer Lloyd, Bureau Veritas, American Bureau of Shipping, Det Norske Veritas, Korean Register of Shipping, Russian Maritime Register of Shipping, Polski Rejestr Statkon and Nippon Kaiji Kyokai / Class NK.

Advantages at a glance

- Retrofittable
- Easy assembly without tooling
- Low weight
- Meets updated IACS requirements
- No chemicals in flame protection mat
- High flexibility
- Clear identification whether coupling is flame protected or not
- Mechanical stress resistant
- Less warehouse costs

Information

- Sizes from 26.9 mm up to 273.0 mm

Materials

W1	W2	W3	W4	W5
				X

Technical data & Ordering information

NORMACONNECT® FGR RFP						
Ø (O.D.)	Designation	Dimensions			Weight of RFP housing (kg/piece)	W5 Product No. EPDM
		a (mm)	d (mm)	H* appr. (mm)		
26.9	NC RFP W5 RFP 26.9	69	60	110	0.09	0573 0000 026
28.0	NC RFP W5 RFP 28.0	69	60	110	0.09	0573 0000 028
30.0	NC RFP W5 RFP 30.0	69	60	110	0.10	0573 0000 030
33.7	NC RFP W5 RFP 33.7	69	65	115	0.10	0573 0000 033
38.0	NC RFP W5 RFP 38.0	75	70	120	0.11	0573 0000 038
42.4	NC RFP W5 RFP 42.4	75	75	125	0.12	0573 0000 042
44.5	NC RFP W5 RFP 44.5	75	75	125	0.12	0573 0000 044
48.3	NC RFP W5 RFP 48.3	75	80	130	0.13	0573 0000 048
54.0	NC RFP W5 RFP 54.0	90	90	135	0.14	0573 0000 054
57.0	NC RFP W5 RFP 57.0	90	90	140	0.16	0573 0000 057
60.3	NC RFP W5 RFP 60.3	90	95	145	0.16	0573 0000 060
76.1	NC RFP W5 RFP 76.1	110	110	160	0.24	0573 0000 076
88.9	NC RFP W5 RFP 88.9	110	120	170	0.26	0573 0000 088
101.6	NC RFP W5 RFP 101.6	110	135	185	0.28	0573 0000 101
104.0	NC RFP W5 RFP 104.0	110	135	185	0.29	0573 0000 104
108.0	NC RFP W5 RFP 108.0	110	140	190	0.30	0573 0000 108
114.3	NC RFP W5 RFP 114.3	110	145	195	0.31	0573 0000 114
133.0	NC RFP W5 RFP 133.0	125	170	220	0.41	0573 0000 133
139.7	NC RFP W5 RFP 139.7	125	175	225	0.43	0573 0000 139
154.0	NC RFP W5 RFP 154.0	125	190	240	0.45	0573 0000 154
159.0	NC RFP W5 RFP 159.0	125	195	245	0.49	0573 0000 159
168.3	NC RFP W5 RFP 168.3	125	205	255	0.50	0573 0000 168
219.1	NC RFP W5 RFP 219.1	155	260	310	0.73	0573 0000 219
273.0	NC RFP W5 RFP 273.0	155	315	365	0.87	0573 0000 273

* Dimensions of the housing are given as assembled on a NORMACONNECT Grip/ Grip E/ Flex/ Flex E pipe coupling. Further sizes available on request.



- 1 Double-lip sealing system
- 2 Standard strip insert
- 3 Anchoring ring

The coupling for plastic pipes

NORMACONNECT® PLAST GRIP /PLAST GRIP E axial restraint pipe couplings are used to connect plastic pipes.

The specially designed anchoring ring, featuring flat rows of teeth, engages into the pipe surface without damaging the plastic material. The force applied is distributed evenly across the pipe surface.

Advantages at a glance

- No welding
- No adjustments to the pipes/connectors necessary
- Usable for weak plastic pipes, PP, PE

Information

- Sizes: 40.0 mm - 406.0 mm
- Working pressure: 16.0 - 6.0 bar
- Material: AISI 304, AISI 316 Ti
- EPDM:
 - Sizes from 26.9 mm up to 168.3 mm - 30 °C up to + 125 °C
 - Sizes > 180.0 mm: - 20 °C up to + 80 °C
- NBR: - 20 °C up to + 80 °C

Materials

W1	W2	W3	W4	W5
	X		X	X

Technical data & Ordering information

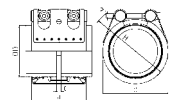

NORMACONNECT® FGR PLAST GRIP														
Ø (O.D.)	Designation	Clamping ranges	PN ¹	WP ²	C max	Dimensions			Weight	Hex socket locking bolts		W5 Product No.		
		O _{dmin} - O _{dmax}	[bar]	[bar]	(mm)	a (mm)	d (mm)	H (mm)	approx. (kg/pc.)	Thread	Tightening torque (Nm)	NBR	EPDM	housing wall thckn.
180.0	PLAST GRIP W5 180	178.0 - 182.0	-	16	35	142	210	240	7.6	M 12 SW 10	60	0581 8650 180	0581 8350 180	3.0 mm
200.0	PLAST GRIP W5 200	198.0 - 202.0	-	16	35	142	230	260	8.1	M 12 SW 10	60	0581 8650 200	0581 8350 200	3.0 mm
219.1	PLAST GRIP W5 219	217.0 - 222.0	-	16	35	142	250	280	8.6	M 12 SW 10	60	0581 8650 219	0581 8350 219	3.0 mm
225.0	PLAST GRIP W5 225	222.0 - 227.0	-	10	35	142	255	285	8.7	M 12 SW 10	60	0581 8650 225	0581 8350 225	3.0 mm
250.0	PLAST GRIP W5 250	247.0 - 253.0	-	10	35	142	280	310	9.4	M 12 SW 10	80	0581 8650 250	0581 8350 250	3.0 mm
273.0	PLAST GRIP W5 273	271.0 - 276.0	-	10	35	142	305	335	9.9	M 16 SW 14	100	0581 8650 273	0581 8350 273	3.0 mm
280.0	PLAST GRIP W5 280	277.0 - 283.0	-	10	35	142	310	340	10.1	M 16 SW 14	100	0581 8650 280	0581 8350 280	3.0 mm
315.0	PLAST GRIP W5 315	311.0 - 318.0	-	10	35	142	345	375	11	M 16 SW 14	100	0581 8650 315	0581 8350 315	3.0 mm
323.9	PLAST GRIP W5 323	320.0 - 327.0	-	6	35	142	355	385	11.2	M 16 SW 14	100	0581 8650 323	0581 8350 323	3.0 mm
355.0	PLAST GRIP W5 355	352.0 - 359.0	-	6	35	142	385	415	12	M 16 SW 14	120	0581 8650 355	0581 8350 355	3.0 mm
400.0	PLAST GRIP W5 400	396.0 - 404.0	-	6	35	142	430	460	13.1	M 16 SW 14	120	0581 8650 400	0581 8350 400	3.0 mm
406.4	PLAST GRIP W5 406.4	402.0 - 410.0	-	6	35	142	440	470	13.3	M 16 SW 14	120	0581 8650 406	0581 8350 406	3.0 mm

PN¹ (Nominal Pressure) is the max. admissible working pressure in shipbuilding, based on a safety factor of ≥ 4.
 WP² is the max. working pressure in industrial applications, with a safety factor as per NORMA specification.

PLAST GRIP E

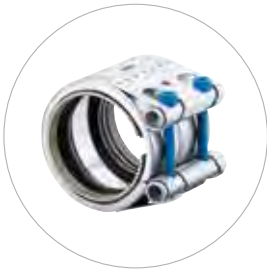

NORMACONNECT® PLAST GRIP E axial restraint pipe couplings are used to connect plastic pipes.

Advantages at a glance

- Hollow trunnion version for smaller diameters

Materials

- W5

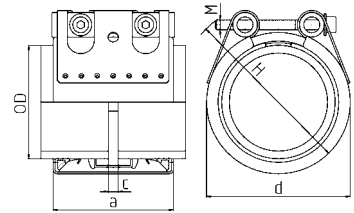

NORMACONNECT® FGR PLAST GRIP E

Ø (O.D.)	Designation	Clamping ranges	PN ¹	WP ²	C max	Dimensions			Weight approx. (kg/pc.)	Hex socket locking bolts		W5 Product No.		
		Odmin - Odmax	[bar]	[bar]	(mm)	a (mm)	d (mm)	H (mm)		Thread	Tightening torque (Nm)	NBR	EPDM	housing wall thickn.
40.0	PLAST GRIP E W5 40	39.0 - 40.5	10	16	8	62	60	80	0.48	M 8 SW 6	15	0581 8660 040	0581 9360 040	1.2 mm
42.4	PLAST GRIP E W5 42	41.7 - 43.0	10	16	8	62	65	85	0.48	M 8 SW 6	15	0581 8660 042	0581 9360 042	1.2 mm
44.5	PLAST GRIP E W5 44	42.0 - 46.0	10	16	8	62	70	90	0.5	M 8 SW 6	15	0581 8660 044	0581 9360 044	1.2 mm
48.3	PLAST GRIP E W5 48	47.6 - 49.5	10	16	8	62	70	90	0.52	M 8 SW 6	15	0581 8660 048	0581 9360 048	1.2 mm
50.0	PLAST GRIP E W5 50	49.0 - 50.5	10	16	8	62	70	90	0.52	M 8 SW 6	15	0581 8660 050	0581 9360 050	1.5 mm
60.3	PLAST GRIP E W5 60	59.5 - 61.0	10	16	17	78	85	105	0.67	M 8 SW 6	20	0581 8660 060	0581 9360 060	1.5 mm
63.0	PLAST GRIP E W5 63	62.0 - 63.5	10	16	17	78	85	105	0.67	M 8 SW 6	20	0581 8660 063	0581 9360 063	1.5 mm
75.0	PLAST GRIP E W5 75	74.0 - 76.0	10	16	25	98	100	120	1.33	M 10 SW 8	30	0581 8660 075	0581 9360 075	1.5 mm
76.1	PLAST GRIP E W5 76	75.0 - 77.0	10	16	25	98	100	120	1.33	M 10 SW 8	30	0581 8660 076	0581 9360 076	1.5 mm
88.9	PLAST GRIP E W5 88	88.0 - 90.0	10	16	25	98	110	130	1.42	M 10 SW 8	30	0581 8660 088	0581 9360 088	1.5 mm
90.0	PLAST GRIP E W5 90	89.0 - 91.0	10	16	25	98	110	130	1.42	M 10 SW 8	30	0581 8660 090	0581 9360 090	1.5 mm
101.3	PLAST GRIP E W5 101	100.4 - 102.8	10	16	25	98	125	145	1.58	M 10 SW 8	30	0581 8660 101	0581 9360 101	1.5 mm
104.0	PLAST GRIP E W5 104	102.8 - 106.1	10	16	25	98	125	145	1.6	M 10 SW 8	30	0581 8660 104	0581 9360 104	1.5 mm
108.0	PLAST GRIP E W5 108	108.8 - 111.4	10	16	25	98	130	150	1.62	M 10 SW 8	30	0581 8660 108	0581 9360 108	1.5 mm
110.0	PLAST GRIP E W5 110	109.0 - 111.0	10	16	25	98	130	150	1.66	M 10 SW 8	30	0581 8660 110	0581 9360 110	1.5 mm
114.3	PLAST GRIP E W5 114	113.0 - 115.5	10	16	25	98	135	155	1.66	M 12 SW 10	40	0581 8660 114	0581 9360 114	1.5 mm
125.0	PLAST GRIP E W5 125	124.0 - 126.0	10	16	35	115	140	160	2.42	M 12 SW 10	40	0581 8660 125	0581 9360 125	2.5 mm
129.0	PLAST GRIP E W5 129	127.6 - 131.1	10	16	35	115	140	160	3.06	M 12 SW 10	40	0581 8660 129	0581 9360 129	2.5 mm
133.0	PLAST GRIP E W5 133	131.5 - 134.4	10	16	35	115	150	170	3.16	M 12 SW 10	40	0581 8660 133	0581 9360 133	2.5 mm
140.0	PLAST GRIP E W5 140	139.0 - 141.0	10	16	35	115	160	180	3.18	M 12 SW 10	50	0581 8660 140	0581 9360 140	2.5 mm
154.0	PLAST GRIP E W5 154	152.3 - 156.1	10	16	35	115	170	190	3.27	M 12 SW 10	50	0581 8660 154	0581 9360 154	2.5 mm
159.0	PLAST GRIP E W5 159	157.3 - 160.7	10	16	35	115	180	200	3.39	M 12 SW 10	50	0581 8660 159	0581 9360 159	2.5 mm
160.0	PLAST GRIP E W5 160	159.0 - 162.0	10	16	35	115	180	200	3.45	M 12 SW 10	60	0581 8660 160	0581 9360 160	2.5 mm
168.3	PLAST GRIP E W5 168	166.5 - 170.1	10	16	35	115	190	200	3.48	M 12 SW 10	60	0581 8660 168	0581 9360 168	2.5 mm

PN¹ (Nominal Pressure) is the max. admissible working pressure in shipbuilding, based on a safety factor of ≥ 4.

WP² is the max. working pressure in industrial applications, with a safety factor as per NORMA specification.

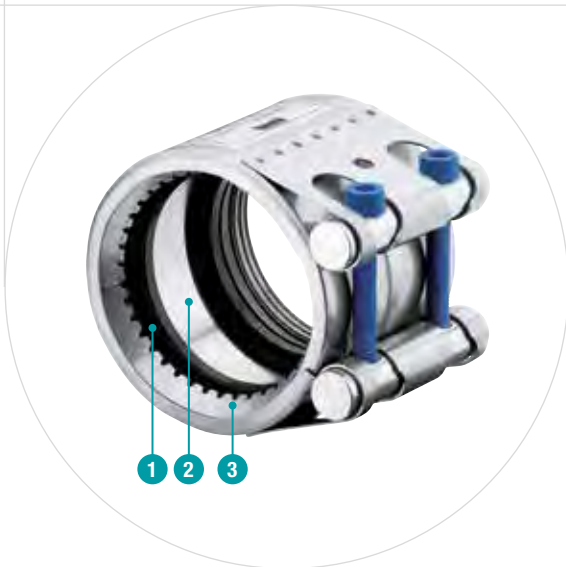

- 1 Double-lip sealing system
- 2 Standard strip insert
- 3 Anchoring ring

The combining pipe coupling

NORMACONNECT® COMBI GRIP/COMBI GRIP E axial restraint pipe couplings are used to connect plastic pipes with metal pipes.

For the plastic pipe the coupling features on one side a special anchoring ring with rows of flat teeth which are pressed into the pipe surface without damaging the material. At the same time the force applied is distributed evenly across the pipe surface.

For the metal pipe the coupling features on the other side an anchoring ring with conically stamped teeth which grip into the pipe surface. Due to the special design of the anchoring ring the coupling can withstand even high vibration loads.

Advantages at a glance

- Corrosion resistant
- No welding
- No special tools necessary
- Installation and working in every kind of weather (hot and cold)
- Reusable

Information

- Sizes: from 38/40.0 mm to 406.0/406.0 mm
- Working pressure: 16.0 - 6.0 bar
- Material: AISI 304, AISI 316 Ti
- EPDM:
 - Sizes from 26.9 mm up to 168.3 mm: - 30 °C up to + 125 °C
 - Sizes > 180.0 mm: - 20 °C up to + 80 °C
- NBR: from - 20 °C up to + 80 °C

Materials

W1	W2	W3	W4	W5
				x

Technical data & Ordering information

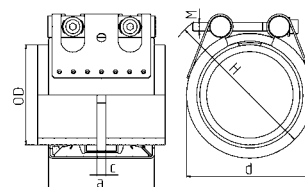

Technical data & Ordering information

NORMACONNECT®

NORMACONNECT® FGR COMBI GRIP															
Ø (O.D.)	Designation	Clamping ranges O _{dmin} - O _{dmax} (mm)		PN ¹ [bar]	WP ² [bar]	C max (mm)	Dimensions			Weight approx. (kg/ pc.)	Hex socket locking bolts		W5 Product No.		
		Plastic	Metal				a (mm)	d (mm)	H (mm)		Thread	Tightening torque (Nm)	NBR	EPDM	housing wall thickn.
200.0 / 204.0	COMBI GRIP 200.0 / 204.0	198.0-202.0	202.0-206.0	-	16	35	142	235	265	7.5	M 12 SW 10	60	0584 8650 204	0584 8350 204	3.0 mm
219.1 / 219.1	COMBI GRIP 219.1 / 219.1	217.0-222.0	216.0-221.0	-	16	35	142	250	280	7.9	M 12 SW 10	60	0584 8650 219	0584 8350 219	3.0 mm
219.1 / 225.0	COMBI GRIP 219.1 / 225.0	222.0-227.0	216.0-221.0	-	10	35	142	255	285	8.1	M 12 SW 10	60	0584 8650 220	0584 8350 220	3.0 mm
222.0 / 225.0	COMBI GRIP 222.0 / 225.0	222.0-227.0	220.0-224.0	-	10	35	142	255	285	8.1	M 12 SW 10	60	0584 8650 222	0584 8350 222	3.0 mm
254.0 / 250.0	COMBI GRIP 254.0 / 250.0	247.0-253.0	250.0-256.0	-	10	35	142	285	315	8.6	M 12 SW 10	80	0584 8650 254	0584 8350 254	3.0 mm
273.0 / 273.0	COMBI GRIP 273.0 / 273.0	271.0-276.0	270.0-275.0	-	10	35	142	305	335	9.1	M 16 SW 14	100	0584 8650 272	0584 8350 272	3.0 mm
273.0 / 280.0	COMBI GRIP 273.0 / 280.0	277.0-283.0	270.0-275.0	-	10	35	142	310	340	9.3	M 16 SW 14	100	0584 8650 273	0584 8350 273	3.0 mm
323.9 / 323.9	COMBI GRIP 323.9 / 323.9	320.0-327.0	320.0-327.0	-	6	35	142	355	385	10.2	M 16 SW 14	100	0584 8650 323	0584 8350 323	3.0 mm
355.0 / 355.6	COMBI GRIP 355.0 / 355.6	351.0-359.0	352.0-359.0	-	6	35	142	390	420	10.9	M 16 SW 14	120	0584 8650 355	0584 8350 355	3.0 mm
400.0 / 406.4	COMBI GRIP 400.0 / 406.4	396.0-404.0	402.0-410.0	-	6	35	142	440	470	11.9	M 16 SW 14	120	0584 8650 400	0584 8350 400	3.0 mm
406.0 / 406.4	COMBI GRIP 406.0 / 406.4	396.0-404.0	402.0-410.0	-	6	35	142	440	470	12	M 16 SW 14	120	0584 8650 406	0584 8350 406	3.0 mm

PN¹ (Nominal Pressure) is the max. admissible working pressure in shipbuilding, based on a safety factor of ≥ 4.
 WP² is the max. working pressure in industrial applications, with a safety factor as per NORMA specification.

COMBI GRIP E



NORMACONNECT® COMBI GRIP E axial restraint pipe couplings are used to connect plastic pipes with metal pipes.

Advantages at a glance

- Hollow trunnion version for smaller diameters

Materials

- W5

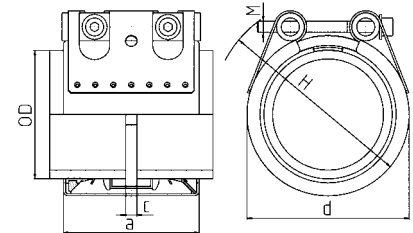

NORMACONNECT®

NORMACONNECT® FGR COMBI GRIP E																
Ø (O.D.)	Designation	Clamping ranges O _{dmin} - O _{dmax} (mm)		PN ¹ [bar]	WP ² [bar]	C max (mm)	Dimensions			Weight approx. (kg/ pc.)	Hex socket locking bolts		W5 Product No.			housing wall thickn.
		Plastic	Metal				a (mm)	d (mm)	H (mm)		Thread	Tightening torque (Nm)	NBR	EPDM		
38.0 / 40.0	COMBI GRIP E 38.0 / 40.0	39.0-40.5	37.5-38.6	10	16	8	62	60	80	0.46	M 8 SW 6	15	0584 8660 038	0584 9360 038	1.2 mm	
42.4 / 40.0	COMBI GRIP E 42.4 / 40.0	39.0-40.5	41.7-43.0	10	16	8	62	65	85	0.47	M 8 SW 6	15	0584 8660 043	0584 9360 043	1.2 mm	
42.4 / 42.4	COMBI GRIP E 42.4 / 42.4	41.7-43.0	41.7-43.0	10	16	8	62	65	85	0.47	M 8 SW 6	15	0584 8660 043	0584 9360 043	1.2 mm	
44.5 / 44.5	COMBI GRIP E 44.5 / 44.5	43.5-45.5	47.6-50.5	10	16	8	62	65	85	0.5	M 8 SW 6	15	0584 8660 044	0584 9360 044	1.2 mm	
48.3 / 50.0	COMBI GRIP E 48.3 / 50.0	47.6-51.0	47.6-50.5	10	16	8	62	70	90	0.5	M 8 SW 6	15	0584 8660 048	0584 9360 048	1.2 mm	
48.3 / 48.3	COMBI GRIP E 48.3 / 48.3	47.6-50.5	53.3-54.6	10	16	17	78	70	90	0.5	M 8 SW 6	15	0584 8660 046	0584 9360 046	1.2 mm	
60.3 / 60.3	COMBI GRIP E 60.3 / 60.3	59.5-61.0	59.5-61.0	10	16	17	78	85	105	0.65	M 8 SW 6	20	0584 8660 061	0584 9360 061	1.2 mm	
60.3 / 63.0	COMBI GRIP E 60.3 / 63.0	62.0-63.5	59.5-61.0	10	16	17	78	85	105	0.65	M 8 SW 6	20	0584 8660 060	0584 9360 060	1.2 mm	
76.1 / 75.0	COMBI GRIP E 76.1 / 75.0	74.0-76.0	75.2-77.0	10	16	25	98	100	120	1.3	M 10 SW 8	30	0584 8660 076	0584 9360 076	1.5 mm	
76.1 / 76.1	COMBI GRIP E 76,1 / 76,1	75.1-77.1	75.2-77.0	10	16	25	98	100	120	1.3	M 10 SW 8	30	0584 8660 077	0584 9360 077	1.5 mm	
88.9 / 88.9	COMBI GRIP E 88.9 / 90.0	88.0-90.0	87.0-89.9	10	16	25	98	110	130	1.39	M 10 SW 8	30	0584 8660 086	0584 9360 086	1.5 mm	
88.9 / 90.0	COMBI GRIP E 88.9 / 90.0	89.0-91.0	87.0-89.9	10	16	25	98	110	130	1.39	M 10 SW 8	30	0584 8660 088	0584 9360 088	1.5 mm	
101.6 / 101.6	COMBI GRIP E 101.6 / 101.6	100.4-102.8	100.4-102.8	10	16	25	98	125	145	1.54	M 10 SW 8	30	0584 8660 101	0584 9360 101	1.5 mm	
108.0 / 110.0	COMBI GRIP E 108.0 / 110.0	109.0-111.0	106.8-109.2	10	16	25	98	130	150	1.58	M 10 SW 8	40	0584 8660 108	0584 9360 108	1.5 mm	
110.0 / 110.0	COMBI GRIP E 110.0 / 110.0	109.0-111.0	106.8-109.2	10	16	25	98	130	150	1.58	M 10 SW 8	40	0584 8660 109	0584 9360 109	1.5 mm	
114.3 / 110.0	COMBI GRIP E 114.3 / 110.0	109.0-111.0	113.0-115.5	10	16	25	98	135	155	1.62	M 10 SW 8	40	0584 8660 110	0584 9360 110	1.5 mm	
114.3 / 114.3	COMBI GRIP E 114.3 / 114.3	113.0-115.5	113.0-115.5	10	16	25	98	135	155	1.62	M 12 SW 10	40	0584 8660 114	0584 9360 114	1.5 mm	
139.7 / 140.0	COMBI GRIP E 139.7 / 140.0	139.0-141.0	138.1-141.6	10	16	35	115	160	180	3.14	M 12 SW 10	50	0584 8660 139	0584 9360 139	2.5 mm	
159.0 / 160.0	COMBI GRIP E 159.0 / 160.0	159.0-162.0	157.3-160.7	10	16	35	115	180	200	3.45	M 12 SW 10	60	0584 8660 159	0584 9360 159	2.5 mm	
168.3 / 168.3	COMBI GRIP E 168.3 / 168.3	166.0-170.1	166.5-170.1	10	16	35	115	190	210	3.48	M 12 SW 10	60	0584 8660 168	0584 9360 168	2.5 mm	

PN¹ (Nominal Pressure) is the max. admissible working pressure in shipbuilding, based on a safety factor of ≥ 4.
 WP² is the max. working pressure in industrial applications, with a safety factor as per NORMA specification.



Support sleeve to be used with NORMACONNECT PLAST GRIP/PLAST GRIP E, COMBIGRIP/COMBI GRIP E in W5 (1.4571) material.

For copper and CuNiFe pipes an optional support sleeve made from brass is available on request.

Optional support sleeve

When joining plastic pipes made from PE and PP a support sleeve must be used. If the pipes to be joined are made from soft thermoplastic (e.g., PE) the use of a support sleeve is mandatory. The support sleeve is inserted into the pipe end within the area to be joined and thus protects the pipe from being deformed.

Technical data & Ordering information

INTERNAL SUPPORT SLEEVE FOR PLAST GRIP / PLAST GRIP E IN W5 (316TI)

Ø OD mm	S-3.2 (SDR 7,5)		S-4 (SDR 9)		S-5 (SDR 11)		S-6.3 (SDR 13.6)	
	Product No.	Ø di* mm	Product No.	Ø di* mm	Product No.	Ø di* mm	Product No.	Ø di* mm
40	0581 1100 029	29	0581 1100 031	31	0581 1100 032	32.6	0581 1100 034	34
50	0581 1100 036	36	0581 1100 038	38.8	0581 1100 040	40.8	0581 1100 042	42.6
63	0581 1100 045	45.6	0581 1100 048	48.8	0581 1100 051	51.4	0581 1100 053	53.6
75	0581 1100 054	54.4	0581 1100 058	58.2	0581 1100 061	61.4	0581 1100 064	64
90	0581 1100 065	65.4	0581 1100 069	69.5	0581 1100 073	73.6	0581 1100 076	76.8
110	0581 1100 079	79.5	0581 1100 085	85.4	0581 1100 090	90	0581 1100 093	93.8
125	0581 1100 091	91	0581 1100 097	97	0581 1100 102	102.2	0581 1100 106	106.6
140	0581 1100 101	101.6	0581 1100 108	108.6	0581 1100 114	114.6	0581 1100 119	119.4
160	0581 1100 116	116.2	0581 1100 124	124.2	0581 1100 130	130.8	0581 1100 136	136.4

* further sizes available on request

INTERNAL SUPPORT SLEEVE FOR PLAST GRIP / PLAST GRIP E IN W5 (316TI)

Ø OD mm	S-8 (SDR 17)		S-10 (SDR 21)		S-12,5 (SDR 26)		S-16 (SDR 33)	
	Product No.	Ø di* mm	Product No.	Ø di* mm	Product No.	Ø di* mm	Product No.	Ø di* mm
40	0581 1100 035	35.2	-	-	0581 1100 036	36	-	-
50	0581 1100 044	44	0581 1100 045	45.6	0581 1100 046	46	-	-
63	0581 1100 055	55.4	0581 1100 057	57	0581 1100 058	58.2	0581 1100 059	59
75	0581 1100 066	66	0581 1100 067	67.8	0581 1100 069	69.5	0581 1100 070	70.4
90	0581 1100 079	79.5	0581 1100 081	81.4	0581 1100 083	83	0581 1100 084	84.4
110	0581 1100 096	96.8	0581 1100 099	99.4	0581 1100 101	101.6	0581 1100 103	103.2
125	0581 1100 110	110.2	0581 1100 113	113	0581 1100 115	115.4	0581 1100 117	117.2
140	0581 1100 123	123.4	0581 1100 126	126.6	0581 1100 129	129.2	0581 1100 131	131.4
160	0581 1100 141	141	0581 1100 144	144.6	0581 1100 147	147.6	0581 1100 150	150.2

* further sizes available on request

Certificates, Liability, Memberships

Certificates Materialprüfungsamt Nordrhein-Westfalen (MPA NRW)

Liability Product liability: In case of bodily injury and/or material damage.

Memberships IZEG – Informationszentrum Entwässerungstechnik Guss
GEG – Gütergemeinschaft Entwässerungstechnik Guss



Informationszentrum
Entwässerungstechnik Guss e.V.













Materials at a Glance

MATERIALS FOR COUPLINGS AND RESTRAINT COLLARS				
	COLLAR	CLAMPING UNIT	SCREWS, NUTS, BOLTS	SEALING SLEEVE
W1			Steel, protected surface	–
W2	AISI 430 Ti	AISI 304	Steel, protected surface	EPDM
W4	AISI 304	AISI 304	AISI 304	EPDM
W5	AISI 316 Ti	AISI 316 Ti	AISI 316	EPDM

	COLLAR	CLAMPING UNIT	SCREWS	SEALING SLEEVE
W2	AISI 304	Steel, protected surface	Steel, protected surface	EPDM
W5	AISI 316 Ti	AISI 316 Ti	AISI 316	EPDM

NORMACONNECT®

Products and Application at a Glance

TYPE	DN AND PRESSURE [bar]												SEAL TYPE	MATERIAL	APPLICATION				
	40	50	70	70/80	100	125	150	200	250	300	400	500			600	STANDARD	Buildings	Bridges	Soil
NON-PULL-OUT RESISTANT CONNECTIONS																			
RAPID 	•	•	•	•	•	•	•	•							EPDM	W 2	•	-	-
RAPID 	•	•	•	•	•	•	•	•	•	•					EPDM	W 5	•	•	•
MSM RAPID 	•	•	•	•	•	•	•								EPDM	W 2	•	-	-
CV 	•	•	•	•	•	•	•	•	•						EPDM	W 2	•	-	-
CE 	•	•		•	•	•	•	•	•						EPDM	W 4	•	-	•*
SVE 	•		•	•	•	•	•								NR-SBR	PP-CO	-	-	•
PULL-OUT RESISTANT CONNECTIONS																			
UNIVERSAL Restraint Collar** 	10	10	10	10	10	5	5	3	3						-	W 2	•	-	-
RECORD Restraint Collar** 	10	10	10	10	10	5	5	3							-	W 1	•	-	-
COMBI Restraint Collar** 	10	10	10	10	5	5									-	W 1	•	-	-
CHANGEDOVER CONNECTORS																			
FIX 	•	•	•	•	•										EPDM	-	•	-	-

* Additional protection against corrosion * NBR on request Technical Changes reserved
** The collars are only suitable for open drainage systems. It is not allowed to use it for closed pressure systems.





- 1 Hexagonal socket bolt with washer
- 2 Square nut
- 3 Closure unit
- 4 Collar
- 5 Sealing sleeve

The original Rapid with block tightening

The DCS RAPID with block tightening for non-pull-out resistant connections enables a fast connection. The visible torque control and the single-bolt closure provide for a fast and easy installation.



Materials

W1	W2	W3	W4	W5
	x			x

- W2, W5**
- Material, Collar: AISI 430 Ti
 - Material, Clamping unit: AISI 304 / AISI 430 Ti
 - Material, Bolts/Nuts: Steel, surface protected
 - Material, Sealing sleeve: EPDM

Information

- Resisting axial pull-out forces up to max. 0.5 bar
- DN 40 – DN 200
- Resisting axial pull-out forces up to max 0.3 bar
- DN 250 – DN 300
- Defined locking torque without using a special tool
- Meeting the fire protection requirements

Technical data & Ordering information

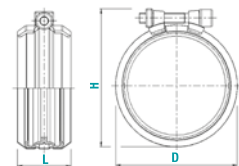

NORMACONNECT® DCS RAPID									
Designation	Max. Dimensions after Assembly ~							W2 Product No.	W5 Product No.
	DN	D (mm)	H (mm)	L (mm)	P max (bar)	Torque (Nm)	Bolt (mm)		
RAPID DN 40	40	53	64	50	0.5	Tight-Locking	M 5	0245 8254 040	
RAPID DN 50	50	70	80	46	0.5	Tight-Locking	M 8	0245 8218 050	0245 8126 050
RAPID DN 70	70	90	100	43	0.5	Tight-Locking	M 8	0245 8219 070	0245 8127 070
RAPID DN 75	75	87	97	40.5	0.5	Tight-Locking	M 8	0245 8265 075	
RAPID DN 80	75/80	95	105	40	0.5	Tight-Locking	M 8	0245 8220 080	0245 8129 075
RAPID DN 100	100	125	135	39.0	0.5	Tight-Locking	M 8	0245 8221 100	0245 8130 100
RAPID DN 125	125	147	162	37.0	0.5	Tight-Locking	M 8	0245 8222 125	0245 8131 125
RAPID DN 150	150	172	187	35.5	0.5	Tight-Locking	M 8	0245 8223 150	0245 8132 150
RAPID DN 200	200	227	244	33.5	0.5	Tight-Locking	M 10	0245 8224 200	0245 8133 200
RAPID DN 250	250	293	306	96	0.3	Tight-Locking	M 10		0245 8208 250
RAPID DN 300	300	345	360	96	0.3	Tight-Locking	M 10		0245 8209 300



- 1 Hexagonal socket bolt with washer
- 2 Square nut
- 3 Closure unit
- 4 Collar
- 5 Sealing sleeve

The fast connection with quick release closure

The DCS RAPID MSM connection is easy-fitting and thus especially suitable for repair purposes. It is the fast connection with quick release closure for non-pull-out resistant connections.



Materials

W1	W2	W3	W4	W5
	x			

- W2**
- Material, Collar: AISI 430 Ti
 - Material, Clamping unit: AISI 304 / AISI 430 Ti
 - Material, Bolts/Nuts: Steel, surface protected
 - Material, Sealing sleeve: EPDM

Information

- Resisting axial pull-out forces up to max. 0.5 bar
- Defined locking torque without using a special tool
- Meeting the fire protection requirements

Technical data & Ordering information

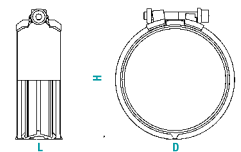

NORMACONNECT® DCS RAPID MSM									
Designation	Max. Dimensions after Assembly ~							W2 Product No.	
	DN	D (mm)	H (mm)	L (mm)	P max (bar)	Torque (Nm)	Bolt (mm)		
RAPID DN 50 MSM	50	70	80	40	0.5	Tight-Locking	M 8	0245 8257 050	
RAPID DN 70 MSM	70	90	100	40	0.5	Tight-Locking	M 8	0245 8258 070	
RAPID DN 80 MSM	75/80	95	105	40	0.5	Tight-Locking	M 8	0245 8260 080	
RAPID DN 100 MSM	100	125	135	46	0.5	Tight-Locking	M 8	0245 8261 100	
RAPID DN 125 MSM	125	147	162	55	0.5	Tight-Locking	M 8	0245 8262 125	
RAPID DN 150 MSM	150	172	187	55	0.5	Tight-Locking	M 8	0245 8263 150	
RAPID DN 200 MSM	200	227	244	70	0.5	Tight-Locking	M 10	0245 8264 200	



- 1 CV: Slotted hexagonal head bolts
DN 50 – DN 300: SW 10
CE: Hexagonal head bolts
DN 50, 70, 75/80: SW 10
DN 100 – DN 300: SW 13
- 2 Guide plate
- 3 Threaded plate
- 4 Collar
- 5 Sealing sleeve

The proven standard collar

The DCS CV/CE collar has been proven in all kinds of standard drainage applications. The proven standard collar for non-pull-out connections.

Materials

W1	W2	W3	W4	W5
	x		x	

- W2**
 - Material, Collar: AISI 430 Ti
- Type CV**
 - Material, Clamping unit: Steel, surface protected
 - Material, Sealing sleeve: EPDM
 - Material, Bolts: Steel, surface protected
- W5**
 - Material, Collar: AISI 304
- Type CE**
 - Material, Clamping unit: AISI 304
 - Material, Sealing sleeve: EPDM
 - Material, Bolts: Steel, surface protected

Advantages at a glance

- Fast and easy installation
- Suitable for repair purposes

Technical data & Ordering information

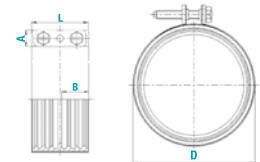

NORMACONNECT® DCS CV								
Designation	DN	A (mm)	B (mm)	D (mm)	L (mm)	Torque (Nm)	Bolt (mm)	W2 Product No.
CV DN 50	50	14	22.5	65	48	4-6	M 6	0242 8091 050
CV DN 70	70	14	22.5	85	48	4-6	M 6	0242 8092 070
CV DN 80	75/80	14	22.5	90	48	6-8	M 6	0242 8093 075
CV DN 100	100	18	22.5	115	54	10-12	M 8	0262 8303 100
CV DN 125	125	18	31	140	65	10-12	M 8	0262 8304 125
CV DN 150	150	18	31	170	65	10-12	M 8	0262 8305 150
CV DN 200	200	18	37	220	78	15-20	M 8	0262 8306 200
CV DN 250	250	18	37	286	78	15-20	M 8	0262 8307 250
CV DN 300	300	18	37	338	78	15-20	M 8	0262 8308 300

DCS CV is also available with a round hexagonal head bolt on request.

NORMACONNECT® DCS CE								
Designation	DN	A (mm)	B (mm)	D (mm)	L (mm)	Torque (Nm)	Bolt (mm)	W4 Product No.
CE DN 50	50	14	22.5	65	48	4-6	M 6	0242 8108 050
CE DN 70	70	14	22.5	85	48	4-6	M 6	0242 8109 070
CE DN 100	100	18	22.5	115	54	10-12	M 8	0262 8361 100
CE DN 125	125	18	31	140	65	10-12	M 8	0262 8362 125
CE DN 150	150	18	31	170	65	10-12	M 8	0262 8363 150
CE DN 200	200	18	37	220	78	15-20	M 8	0262 8364 200
CE DN 250	250	18	37	286	78	15-20	M 8	0262 8365 250
CE DN 300	300	18	37	338	78	15-20	M 8	0262 8366 300

DCS CE is also available with a round hexagonal head bolt on request.



- 1 Housing
- 2 Sealing lips

The collar for buried drainage pipes

Used to achieve fast and easy connection of below ground drainage pipes, while also accommodating larger gaps between pipe ends. The DCS collar for buried drainage pipes for non-pull-out connections is the universal solution for many applications.

Materials

- Material, Housing: Polypropylene-CO
- Material, Seal: NR-SBR

Information

- Collar made from polypropylene with built-in sealing lips
- Compensates for larger gaps between pipe ends

Technical data & Ordering information

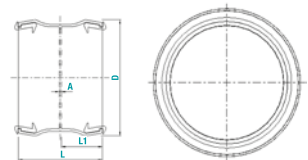

NORMACONNECT® DCS SVE CONNECTION, PP-CO with built-in sealing lips NR-SBR

Designation	DN	D (mm)	L (mm)	L' (mm)	A (mm)	Bolt (mm)	Polypropylene-CO Product No.
DCS SVE DN 50	50	77	60	29	2	M 6	0242 8108 050
DCS SVE DN 80	75/80	103.5	65.5	32	2	M 6	0242 8109 070
DCS SVE DN 100	100	134	82	39.5	3	M 8	0262 8361 100
DCS SVE DN 125	125	161	103	50	3	M 8	0262 8362 125
DCS SVE DN 150	150	186	103	50	3	M 8	0262 8363 150
DCS SVE DN 200	200	238	114	55.5	3	M 8	0262 8364 200



- 1 Hexagonal socket bolts
- 2 Guide bolt
- 3 Threaded bolt
- 4 Housing
- 5 Grip ring insert

The grip-type coupling which resists high tensile loads

Combined with either DCS RAPID, DCS RAPID MSM or DCS CV/CE standards collars, our DCS Universal restraint collars ensure that the system can withstand even high tensile loads. The grip-type coupling which resists high tensile loads for non-pull-out resistant connections.



Materials

W1	W2	W3	W4	W5
	x			

- W2**
- Material, Housing: AISI 430 Ti
 - Material, Closure unit: Steel, surface protected
 - Material, Grip ring: AISI 301

Information

- Recommended for use in combination with types RAPID/RAPID MSM: up to max. 10 bar
- Recommended for use in combination with types CV/CE: up to max. 5 bar (DN 50 – DN 200); up to max. 3 bar (DN 250 – DN 300)

Technical data & Ordering information

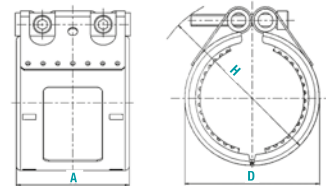

NORMACONNECT® DCS UNIVERSAL RESTRAINT COLLAR									
Designation	DN	A (mm)	D (mm)	H (mm)	Bolt (mm)	P max (bar)		Torque (Nm)	W2 Product No.
						RAPID / RAPID MSM	CV/CE		
UNIVERSAL RESTRAINT COLLAR DN 50	50	77	85	105	M 8	10	5	Tight-Locking	0262 8401 050
UNIVERSAL RESTRAINT COLLAR DN 70	70	77	100	120	M 8	10	5	Tight-Locking	0262 8402 070
UNIVERSAL RESTRAINT COLLAR DN 80	75/80	77	105	125	M 8	10	5	Tight-Locking	0262 8403 080
UNIVERSAL RESTRAINT COLLAR DN 100	100	97	130	150	M 10	10	5	Tight-Locking	0262 8405 100
UNIVERSAL RESTRAINT COLLAR DN 125	125	97	165	195	M 10	10	5	Tight-Locking	0262 8406 125
UNIVERSAL RESTRAINT COLLAR DN 150	150	97	185	215	M 10	5	5	Tight-Locking	0262 8407 150
UNIVERSAL RESTRAINT COLLAR DN 200	200	113	240	270	M 12	5	5	Tight-Locking	0262 8415 200
UNIVERSAL RESTRAINT COLLAR DN 250	250	139	305	335	M 12	3	3	Tight-Locking	0262 8416 250
UNIVERSAL RESTRAINT COLLAR DN 300	300	139	400	490	M 12	3	3	Tight-Locking	0262 8417 300

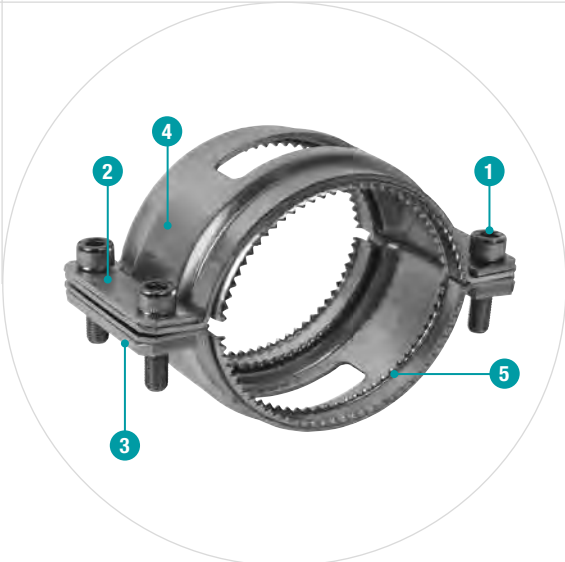

- 1 Hexagonal socket bolt with fine pitch thread
- 2 Guiding plate
- 3 Threaded plate
- 4 Housing
- 5 Grip ring insert (hardened)

The powerful add-on collar

Axial restraint safety clamp for use with pressurized pump lines in lifting systems as well as for rainwater sewage lines that are at risk of undergoing back pressures, but only in combination with the DCS RAPID standard collar. The powerful add-on collar for non-pull-out resistant connections.

Materials

W1	W2	W3	W4	W5
x				

- W1**
- Material, Housing: Steel, surface protected
 - Material, Closure unit: Steel, surface protected

Advantages at a glance

- Two parts (halves) with hardened grip ring inserts
- Strong guiding plates with threaded holes plus four hexagonal socket bolts with fine pitch thread

Technical data & Ordering information

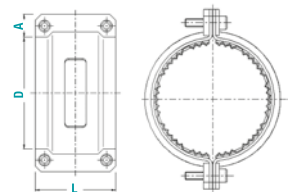

NORMACONNECT® DCS RECORD RESTRAINT COLLAR								
Designation	DN	A (mm)	D (mm)	L (mm)	Torque (Nm)	Bolt (mm)	P max (bar)	W1 Product No.
RECORD RESTRAINT COLLAR DN 40	40	21	65	66	12-15	M 8	up to 10	0262 1272 040
RECORD RESTRAINT COLLAR DN 50	50	21	75	69	12-15	M 8	up to 10	0262 1265 050
RECORD RESTRAINT COLLAR DN 70	70	21	95	69	12-15	M 8	up to 10	0262 1266 070
RECORD RESTRAINT COLLAR DN 80	75/80	21	100	69	12-15	M 8	up to 10	0262 1287 080
RECORD RESTRAINT COLLAR DN 100	100	25	135	87	25-30	M 10	up to 10	0262 1246 100
RECORD RESTRAINT COLLAR DN 125	125	25	160	95	30-35	M 10	up to 5	0262 1267 125
RECORD RESTRAINT COLLAR DN 150	150	25	185	95	30-35	M 10	up to 5	0262 1268 150
RECORD RESTRAINT COLLAR DN 200	200	30	235	111	60-65	M 12	up to 3	0262 1269 200

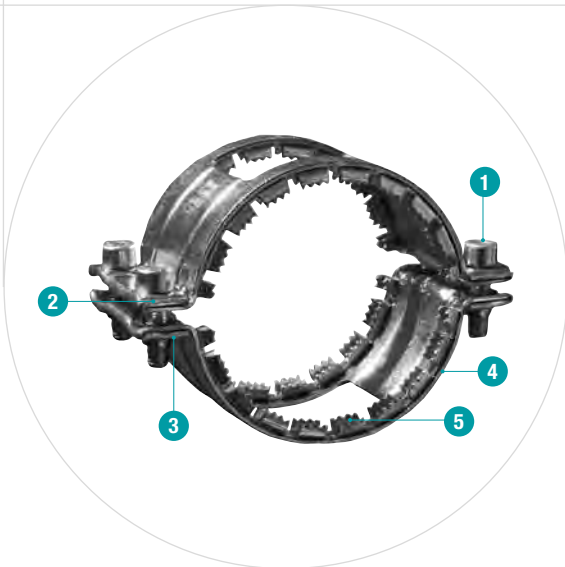

- 1 Hexagonal socket bolts
- 2 Guiding side
- 3 Threaded side
- 4 Housing
- 5 Grip ring insert

The powerful add-on collar

Axial restraint safety clamp for connecting rainwater and sewage lines that are at risk of undergoing back pressures, used in combination with RAPID/RAPID MSM and CV or CE standard collars. The powerful add-on collar for non-pull-out resistant connections.

Materials

W1	W2	W3	W4	W5
x				

- W1**
- Material, Housing: Steel, surface protected
 - Material, Closure unit: Steel, surface protected

Information

- Axial restraint up to 10 bar
- Diameters DN50 up to DN 150

Technical data & Ordering information

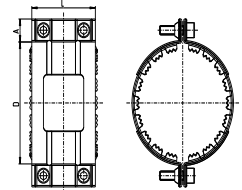

NORMACONNECT® DCS COMBI RESTRAINT COLLAR								
Designation	DN	A (mm)	D (mm)	L (mm)	Torque (Nm)	Bolt (mm)	P max (bar)	W1 Product No.
COMBI RESTRAINT COLLAR DN 50	50	22	81	72	18-20	M 8	up to 10	2628590050
COMBI RESTRAINT COLLAR DN 70	70	22	102	72	18-20	M 8	up to 10	2628590070
COMBI RESTRAINT COLLAR DN 80	80	22	110	72	18-20	M 8	up to 10	2628590080
COMBI RESTRAINT COLLAR DN 100	100	22	136	82	28-30	M 10	up to 10	2628591100
COMBI RESTRAINT COLLAR DN 125	125	23.5	162	93	28-30	M 10	up to 5	2628592125
COMBI RESTRAINT COLLAR DN 150	150	23.5	189	93	33-35	M 10	up to 5	2628592150



- 1 Easy handling
- 2 Strong worm-drive hose clip

The changeover connector with 2 lip seals

Materials

W1	W2	W3	W4	W5
	x			

- Material, Connector: EPDM
- Material, Worm-drive hose clip band: AISI 430

Advantages at a glance

- The connection of feed or suction lines to a pipe – either made of steel or plastics – is easily and safely achieved with the FIX connector.

Technical data & Ordering information

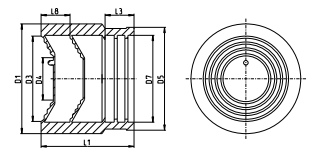

NORMACONNECT® DCS FIX, EPDM with TORRO W2, Changeover Connector										
Designation	DN	D1 (mm)	D3 (mm)	D4 (mm)	D5 (mm)	D7 (mm)	L1 (mm)	L3 (mm)	L8 (mm)	W2 Product No.
FIX DN 50	50	72	56	30	67.5	57	63	19	19	0245 9003 050
FIX DN 70	70	92	75	41	86.5	77	77	19	24	0245 9003 070
FIX DN 80 56-75	80	92	75	41	91	81	77	19	24	0245 9003 075
FIX DN 80 75-90	80	108	90	58	93	81	88	19	23	0245 9003 080
FIX DN 100	100	128	110	78	118	108	95	21	23	0245 9003 100
FIX DN 125	125	145	126	90	145	132	103	21	27	0245 9003 125

Dimensions of pipes and fittings to EN 877

Dimensions of pipes and fittings to EN 877				
DN	Outside Diameter (OD)		Wall Thickness	
	Nominal value	Tolerances	Nominal value	Minimum value
40	48	+2 -1	3.0	2.5
50	58	+2 -1	3.5	3.0
70	78	+2 -1	3.5	3.0
75/80	83	+2 -1	3.5	3.0
100	110	+2 -1	3.5	3.0
125	135	+2 -2	4.0	3.5
150	160	+2 -2	4.0	3.5
200	210	+2.5 -2.5	5.0	4.0
250	274	+2.5 -2.5	5.5	4.5
300	326	+2.5 -2.5	6.0	5.0
400	429	+2 -3	6.3	5.0
500	532	+2 -3,5	7.0	5.2
600	635	+2 -4	7.7	5.8

Dimensions in mm





- 1 Male threaded adaptor -MA
- 2 Straight coupler - SC
- 3 Female threaded adaptor - FA
- 4 Flange adaptor - FLA
- 5 Equal bend -EB
- 6 Male threaded elbow - MB
- 7 Female threaded elbow - FB
- 8 Male threaded tee - MT
- 9 Female threaded tee - FT

PN 16 for non-potable water

NORMA® Compression fittings are made of polypropylene for high-and-low density polyethylene tubing, diameters 20 to 110. Maximum service pressure: PN 16 bar from diameter 20 to diameter 63 – PN 12.5 bar from diameter 75 to diameter 110. DOES NOT INCLUDE hot water application. NORMA products are made in factories certified under ISO 9001 Version 2008. NORMA® fittings are tested and approved according to these standards: ISO 14236 (Czech Republic). ITC (Poland): BS Standard 5114, AS / NZ 4129, AS 4020. These products are not certified as compliant with international sanitary regulations for transport of potable water and liquid foods.



Advantages at a glance

- Safe and durable
- Fast and easily connected
- Perfect water tightness
- Locking nut for a clinching system
- Simple insertion of the tube in the fitting
- No special workforce required
- High resistance to temperature and ultraviolet shocks

Applications

- Watering: Residential, municipal, sport fields, golf courses.
- Irrigation: Agriculture, horticulture, vineyards.
- Industry: Compressed air.

Information

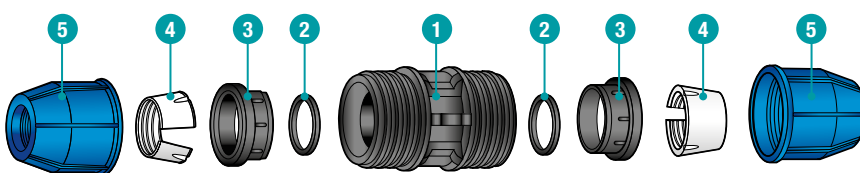

- 1 Body of Polypropylene
- 2 O-ring of NBR
- 3 Holder of Polypropylene
- 4 Clinching Ring of POM, acetal
- 5 Locking nut of Polypropylene

Male threaded adaptor – MA



Size mm x inch	Designation	Polypropylene homopolymer Product No.
20 x 1/2"	MALE THREADED ADAPTOR (MA) 20 x 1/2"	0796 2651 118
20 x 3/4"	MALE THREADED ADAPTOR (MA) 20 x 3/4"	0796 2651 120
20 x 1"	MALE THREADED ADAPTOR (MA) 20 x 1"	0796 2651 117
25 x 1/2"	MALE THREADED ADAPTOR (MA) 25 x 1/2"	0796 2651 121
25 x 3/4"	MALE THREADED ADAPTOR (MA) 25 x 3/4"	0796 2651 122
25 x 1"	MALE THREADED ADAPTOR (MA) 25 x 1"	0796 2651 124
32 x 1/2"	MALE THREADED ADAPTOR (MA) 32 x 1/2"	0796 2651 126
32 x 3/4"	MALE THREADED ADAPTOR (MA) 32 x 3/4"	0796 2651 127
32 x 1"	MALE THREADED ADAPTOR (MA) 32 x 1"	0796 2651 128
32 x 1 1/4"	MALE THREADED ADAPTOR (MA) 32 x 1 1/4"	0796 2651 130
40 x 3/4"	MALE THREADED ADAPTOR (MA) 40 x 3/4"	0796 2651 131
40 x 1"	MALE THREADED ADAPTOR (MA) 40 x 1"	0796 2651 132
40 x 1 1/4"	MALE THREADED ADAPTOR (MA) 40 x 1 1/4"	0796 2651 133
40 x 1 1/2"	MALE THREADED ADAPTOR (MA) 40 x 1 1/2"	0796 2651 134
50 x 1 1/4"	MALE THREADED ADAPTOR (MA) 50 x 1 1/4"	0796 2651 135
50 x 1 1/2"	MALE THREADED ADAPTOR (MA) 50 x 1 1/2"	0796 2651 136
50 x 2"	MALE THREADED ADAPTOR (MA) 50 x 2"	0796 2651 137
63 x 1 1/2"	MALE THREADED ADAPTOR (MA) 63 x 1 1/2"	0796 2651 138
63 x 2"	MALE THREADED ADAPTOR (MA) 63 x 2"	0796 2651 139
75 x 2"	MALE THREADED ADAPTOR (MA) 75 x 2"	0796 2640 310
75 x 2 1/2"	MALE THREADED ADAPTOR (MA) 75 x 2 1/2"	0796 2640 311
90 x 3"	MALE THREADED ADAPTOR (MA) 90 x 3"	0796 2640 312
110 x 4"	MALE THREADED ADAPTOR (MA) 110 x 4"	0796 2640 313

Female threaded adaptor – FA



Size mm x inch	Designation	Polypropylene homopolymer Product No.
20 x 1/2"	FEMALE THREADED ADAPTOR (FA) 20 x 1/2"	0796 2651 018
20 x 3/4"	FEMALE THREADED ADAPTOR (FA) 20 x 3/4"	0796 2651 020
25 x 1/2"	FEMALE THREADED ADAPTOR (FA) 25 x 1/2"	0796 2651 022
25 x 3/4"	FEMALE THREADED ADAPTOR (FA) 25 x 3/4"	0796 2651 025
25 x 1"	FEMALE THREADED ADAPTOR (FA) 25 x 1"	0796 2651 028
32 x 3/4"	FEMALE THREADED ADAPTOR (FA) 32 x 3/4"	0796 2651 030
32 x 1"	FEMALE THREADED ADAPTOR (FA) 32 x 1"	0796 2651 033
32 x 1 1/4"	FEMALE THREADED ADAPTOR (FA) 32 x 1 1/4"	0796 2651 035
40 x 1"	FEMALE THREADED ADAPTOR (FA) 40 x 1"	0796 2651 037
40 x 1 1/4"	FEMALE THREADED ADAPTOR (FA) 40 x 1 1/4"	0796 2651 039
40 x 1 1/2"	FEMALE THREADED ADAPTOR (FA) 40 x 1 1/2"	0796 2651 041
50 x 1 1/2"	FEMALE THREADED ADAPTOR (FA) 50 x 1 1/2"	0796 2651 043
50 x 2"	FEMALE THREADED ADAPTOR (FA) 50 x 2"	0796 2651 045
63 x 1 1/2"	FEMALE THREADED ADAPTOR (FA) 63 x 1 1/2"	0796 2651 047
63 x 2"	FEMALE THREADED ADAPTOR (FA) 63 x 2"	0796 2651 049
75 x 2"	FEMALE THREADED ADAPTOR (FA) 75 x 2"	0796 2640 291
75 x 2 1/2"	FEMALE THREADED ADAPTOR (FA) 75 x 2 1/2"	0796 2640 293
90 x 3"	FEMALE THREADED ADAPTOR (FA) 90 x 3"	0796 2640 295
110 x 4"	FEMALE THREADED ADAPTOR (FA) 110 x 4"	0796 2640 297

Male threaded tee – MT



Size mm x inch	Designation	Polypropylene homopolymer Product No.
20 x 1/2"	MALE THREADED TEE (MT) 20 x 1/2"	0796 2651 154
20 x 3/4"	MALE THREADED TEE (MT) 20 x 3/4"	0796 2651 155
25 x 1/2"	MALE THREADED TEE (MT) 25 x 1/2"	0796 2651 156
25 x 3/4"	MALE THREADED TEE (MT) 25 x 3/4"	0796 2651 157
25 x 1"	MALE THREADED TEE (MT) 25 x 1"	0796 2651 158
32 x 3/4"	MALE THREADED TEE (MT) 32 x 3/4"	0796 2651 159
32 x 1"	MALE THREADED TEE (MT) 32 x 1"	0796 2651 160
40 x 1"	MALE THREADED TEE (MT) 40 x 1"	0796 2651 161
40 x 1 1/4"	MALE THREADED TEE (MT) 40 x 1 1/4"	0796 2651 162
50 x 1 1/4"	MALE THREADED TEE (MT) 50 x 1 1/4"	0796 2651 163
50 x 1 1/2"	MALE THREADED TEE (MT) 50 x 1 1/2"	0796 2651 164
63 x 2"	MALE THREADED TEE (MT) 63 x 2"	0796 2651 165
75 x 2"	MALE THREADED TEE (MT) 75 x 2"	0796 2640 318
75 x 2 1/2"	MALE THREADED TEE (MT) 75 x 2 1/2"	0796 2640 319
90 x 3"	MALE THREADED TEE (MT) 90 x 3"	0796 2640 320
110 x 4"	MALE THREADED TEE (MT) 110 x 4"	0796 2640 321

Female threaded tee – FT



Size mm x inch	Designation	Polypropylene homopolymer Product No.
20 x 1/2"	FEMALE THREADED TEE (FT) 20 x 1/2"	0796 2651 088
20 x 3/4"	FEMALE THREADED TEE (FT) 20 x 3/4"	0796 2651 090
25 x 1/2"	FEMALE THREADED TEE (FT) 25 x 1/2"	0796 2651 092
25 x 3/4"	FEMALE THREADED TEE (FT) 25 x 3/4"	0796 2651 094
25 x 1"	FEMALE THREADED TEE (FT) 25 x 1"	0796 2651 096
32 x 3/4"	FEMALE THREADED TEE (FT) 32 x 3/4"	0796 2651 098
32 x 1"	FEMALE THREADED TEE (FT) 32 x 1"	0796 2651 100
32 x 1 1/4"	FEMALE THREADED TEE (FT) 32 x 1 1/4"	0796 2651 102
40 x 1"	FEMALE THREADED TEE (FT) 40 x 1"	0796 2651 104
40 x 1 1/4"	FEMALE THREADED TEE (FT) 40 x 1 1/4"	0796 2651 106
40 x 1 1/2"	FEMALE THREADED TEE (FT) 40 x 1 1/2"	0796 2651 108
50 x 1 1/2"	FEMALE THREADED TEE (FT) 50 x 1 1/2"	0796 2651 110
50 x 2"	FEMALE THREADED TEE (FT) 50 x 2"	0796 2651 112
63 x 1 1/2"	FEMALE THREADED TEE (FT) 63 x 1 1/2"	0796 2651 114
63 x 2"	FEMALE THREADED TEE (FT) 63 x 2"	0796 2651 116
75 x 2 1/2"	FEMALE THREADED TEE (FT) 75 x 2 1/2"	0796 2640 305
90 x 3"	FEMALE THREADED TEE (FT) 90 x 3"	0796 2640 307
110 x 4"	FEMALE THREADED TEE (FT) 110 x 4"	0796 2640 309

Male threaded elbow – MB



Size mm x inch	Designation	Polypropylene homopolymer Product No.
20 x 1/2"	MALE THREADED ELBOW - MALE BEND 90 (MB) 20 x 1/2"	0796 2651 140
20 x 3/4"	MALE THREADED ELBOW - MALE BEND 90 (MB) 20 x 3/4"	0796 2651 141
25 x 1/2"	MALE THREADED ELBOW - MALE BEND 90 (MB) 25 x 1/2"	0796 2651 142
25 x 3/4"	MALE THREADED ELBOW - MALE BEND 90 (MB) 25 x 3/4"	0796 2651 143
25 x 1"	MALE THREADED ELBOW - MALE BEND 90 (MB) 25 x 1"	0796 2651 144
32 x 3/4"	MALE THREADED ELBOW - MALE BEND 90 (MB) 32 x 3/4"	0796 2651 145
32 x 1"	MALE THREADED ELBOW - MALE BEND 90 (MB) 32 x 1"	0796 2651 146
40 x 1"	MALE THREADED ELBOW - MALE BEND 90 (MB) 40 x 1"	0796 2651 147
40 x 1 1/4"	MALE THREADED ELBOW - MALE BEND 90 (MB) 40 x 1 1/4"	0796 2651 148
40 x 1 1/2"	MALE THREADED ELBOW - MALE BEND 90 (MB) 40 x 1 1/2"	0796 2651 149
50 x 1 1/4"	MALE THREADED ELBOW - MALE BEND 90 (MB) 50 x 1 1/4"	0796 2651 150
50 x 1 1/2"	MALE THREADED ELBOW - MALE BEND 90 (MB) 50 x 1 1/2"	0796 2651 151
50 x 2"	MALE THREADED ELBOW - MALE BEND 90 (MB) 63 x 2"	0796 2651 152
63 x 2"	MALE THREADED ELBOW - MALE BEND 90 (MB) 63 x 2"	0796 2651 153
75 x 2"	MALE THREADED ELBOW - MALE BEND 90 (MB) 75 x 2"	0796 2640 314
75 x 2 1/2"	MALE THREADED ELBOW - MALE BEND 90 (MB) 75 x 2 1/2"	0796 2640 315
90 x 3"	MALE THREADED ELBOW - MALE BEND 90 (MB) 90 x 3"	0796 2640 316
110 x 4"	MALE THREADED ELBOW - MALE BEND 90 (MB) 110 x 4"	0796 2640 317

Female threaded elbow – FB



Size mm x inch	Designation	Polypropylene homopolymer Product No.
20 x 1/2"	FEMALE THREADED ELBOW - FEMALE BEND 90 (FB) 20 x 1/2"	0796 2651 051
20 x 3/4"	FEMALE THREADED ELBOW - FEMALE BEND 90 (FB) 20 x 3/4"	0796 2651 054
25 x 1/2"	FEMALE THREADED ELBOW - FEMALE BEND 90 (FB) 25 x 1/2"	0796 2651 056
25 x 3/4"	FEMALE THREADED ELBOW - FEMALE BEND 90 (FB) 25 x 3/4"	0796 2651 059
25 x 1"	FEMALE THREADED ELBOW - FEMALE BEND 90 (FB) 25 x 1"	0796 2651 061
32 x 1/2"	FEMALE THREADED ELBOW - FEMALE BEND 90 (FB) 32 x 1/2"	0796 2651 063
32 x 3/4"	FEMALE THREADED ELBOW - FEMALE BEND 90 (FB) 32 x 3/4"	0796 2651 065
32 x 1"	FEMALE THREADED ELBOW - FEMALE BEND 90 (FB) 32 x 1"	0796 2651 068
32 x 1 1/4"	FEMALE THREADED ELBOW - FEMALE BEND 90 (FB) 32 x 1 1/4"	0796 2651 070
40 x 1"	FEMALE THREADED ELBOW - FEMALE BEND 90 (FB) 40 x 1"	0796 2651 072
40 x 1 1/4"	FEMALE THREADED ELBOW - FEMALE BEND 90 (FB) 40 x 1 1/4"	0796 2651 074
40 x 1 1/2"	FEMALE THREADED ELBOW - FEMALE BEND 90 (FB) 40 x 1 1/2"	0796 2651 076
50 x 1 1/4"	FEMALE THREADED ELBOW - FEMALE BEND 90 (FB) 50 x 1 1/4"	0796 2651 078
50 x 1 1/2"	FEMALE THREADED ELBOW - FEMALE BEND 90 (FB) 50 x 1 1/2"	0796 2651 080
50 x 2"	FEMALE THREADED ELBOW - FEMALE BEND 90 (FB) 50 x 2"	0796 2651 082
63 x 1 1/2"	FEMALE THREADED ELBOW - FEMALE BEND 90 (FB) 63 x 1 1/2"	0796 2651 084
63 x 2"	FEMALE THREADED ELBOW - FEMALE BEND 90 (FB) 63 x 2"	0796 2651 086
75 x 2 1/2"	FEMALE THREADED ELBOW - FEMALE BEND 90 (FB) 75 x 2 1/2"	0796 2640 299
90 x 3"	FEMALE THREADED ELBOW - FEMALE BEND 90 (FB) 90 x 3"	0796 2640 301
110 x 4"	FEMALE THREADED ELBOW - FEMALE BEND 90 (FB) 110 x 4"	0796 2640 303

Straight coupler – SC



Size mm x inch	Designation	Polypropylene homopolymer Product No.
20	STRAIGHT COUPLER (SC) 20	0796 2651 191
25	STRAIGHT COUPLER (SC) 25	0796 2651 192
32	STRAIGHT COUPLER (SC) 32	0796 2651 193
40	STRAIGHT COUPLER (SC) 40	0796 2651 194
50	STRAIGHT COUPLER (SC) 50	0796 2651 195
63	STRAIGHT COUPLER (SC) 63	0796 2651 196
75	STRAIGHT COUPLER (SC) 75	0796 2640 334
90	STRAIGHT COUPLER (SC) 90	0796 2640 335
110	STRAIGHT COUPLER (SC) 110	0796 2640 336

Equal bend – EB



Size mm x inch	Designation	Polypropylene homopolymer Product No.
20	EQUAL BEND (EB) 20	0796 2650 998
25	EQUAL BEND (EB) 25	0796 2650 999
32	EQUAL BEND (EB) 32	0796 2651 000
40	EQUAL BEND (EB) 40	0796 2651 001
50	EQUAL BEND (EB) 50	0796 2651 002
63	EQUAL BEND (EB) 63	0796 2651 003
75	EQUAL BEND (EB) 75	0796 2640 281
90	EQUAL BEND (EB) 90	0796 2640 282
110	EQUAL BEND (EB) 110	0796 2640 283

Equal tee – ET



Size mm x inch	Designation	Polypropylene homopolymer Product No.
20	EQUAL TEE (ET) 20	0796 2651 010
25	EQUAL TEE (ET) 25	0796 2651 011
32	EQUAL TEE (ET) 32	0796 2651 012
40	EQUAL TEE (ET) 40	0796 2651 013
50	EQUAL TEE (ET) 50	0796 2651 014
63	EQUAL TEE (ET) 63	0796 2651 015
75	EQUAL TEE (ET) 75	0796 2640 287
90	EQUAL TEE (ET) 90	0796 2640 288
110	EQUAL TEE (ET) 110	0796 2640 289

End cap – EC



Size mm x inch	Designation	Polypropylene homopolymer Product No.
20	END CAP (EC) 20	0796 2651 004
25	END CAP (EC) 25	0796 2651 005
32	END CAP (EC) 32	0796 2651 006
40	END CAP (EC) 40	0796 2651 007
50	END CAP (EC) 50	0796 2651 008
63	END CAP (EC) 63	0796 2651 009
75	END CAP (EC) 75	0796 2640 284
90	END CAP (EC) 90	0796 2640 285
110	END CAP (EC) 110	0796 2640 286

Reducing coupler – RC



Size mm x inch	Designation	Polypropylene homopolymer Product No.
25 x 20	REDUCING COUPLER (RC) 25 x 20	0796 2651 166
32 x 20	REDUCING COUPLER (RC) 32 x 20	0796 2651 167
32 x 25	REDUCING COUPLER (RC) 32 x 25	0796 2651 168
40 x 20	REDUCING COUPLER (RC) 40 x 20	0796 2651 169
40 x 25	REDUCING COUPLER (RC) 40 x 25	0796 2651 170
40 x 32	REDUCING COUPLER (RC) 40 x 32	0796 2651 171
50 x 20	REDUCING COUPLER (RC) 50 x 20	0796 2651 172
50 x 25	REDUCING COUPLER (RC) 50 x 25	0796 2651 173
50 x 32	REDUCING COUPLER (RC) 50 x 32	0796 2651 174
50 x 40	REDUCING COUPLER (RC) 50 x 40	0796 2651 175
63 x 25	REDUCING COUPLER (RC) 63 x 25	0796 2651 176
63 x 32	REDUCING COUPLER (RC) 63 x 32	0796 2651 177
63 x 40	REDUCING COUPLER (RC) 63 x 40	0796 2651 178
63 x 50	REDUCING COUPLER (RC) 63 x 50	0796 2651 179
75 x 40	REDUCING COUPLER (RC) 75 x 40	0796 2640 322
75 x 50	REDUCING COUPLER (RC) 75 x 50	0796 2640 323
75 x 63	REDUCING COUPLER (RC) 75 x 63	0796 2640 324
90 x 63	REDUCING COUPLER (RC) 90 x 63	0796 2640 325
90 x 75	REDUCING COUPLER (RC) 90 x 75	0796 2640 326
110 x 90	REDUCING COUPLER (RC) 110 x 90	0796 2640 327

Reducing tee – RT



Size mm x inch	Designation	Polypropylene homopolymer Product No.
25 x 20	REDUCING TEE (RT) 25 x 20	0796 2651 180
32 x 20	REDUCING TEE (RT) 32 x 20	0796 2651 181
32 x 25	REDUCING TEE (RT) 32 x 25	0796 2651 182
40 x 25	REDUCING TEE (RT) 40 x 25	0796 2651 183
40 x 32	REDUCING TEE (RT) 40 x 32	0796 2651 184
50 x 25	REDUCING TEE (RT) 50 x 25	0796 2651 185
50 x 32	REDUCING TEE (RT) 50 x 32	0796 2651 186
50 x 40	REDUCING TEE (RT) 50 x 40	0796 2651 187
63 x 32	REDUCING TEE (RT) 63 x 32	0796 2651 188
63 x 40	REDUCING TEE (RT) 63 x 40	0796 2651 189
63 x 50	REDUCING TEE (RT) 63 x 50	0796 2651 190
75 x 40	REDUCING TEE (RT) 75 x 40	0796 2640 328
75 x 50	REDUCING TEE (RT) 75 x 50	0796 2640 329
75 x 63	REDUCING TEE (RT) 75 x 63	0796 2640 330
90 x 63	REDUCING TEE (RT) 90 x 63	0796 2640 331
90 x 75	REDUCING TEE (RT) 90 x 75	0796 2640 332
110 x 90	REDUCING TEE (RT) 110 x 90	0796 2640 333

Flange adaptor – FLA



Size mm x inch	Designation	Polypropylene homopolymer Product No.
63 x 50DN	FLANGE ADAPTOR (FLA) 63 x 50DN	0796 2600 004
90 x 80DN	FLANGE ADAPTOR (FLA) 90 x 80DN	0796 2600 005
110 x 100DN	FLANGE ADAPTOR (FLA) 110 x 100DN	0796 2600 006

Pop-up Equal bend – PE



Size mm x inch	Designation	Polypropylene homopolymer Product No.
20 x 1/2"	POP-UP EQUAL BEND (PE) 20 x 1/2"	0796 2030 181
25 x 1/2"	POP-UP EQUAL BEND (PE) 25 x 1/2"	0796 2030 182
32 x 3/4"	POP-UP EQUAL BEND (PE) 32 x 3/4"	0796 2030 183

NORMACONNECT®

Wall plate elbow – WPE



Size mm x inch	Designation	Polypropylene homopolymer Product No.
25 x 3/4"	WALL PLATE ELBOW (WPE) 25 x 3/4"	0796 2030 360

Male threaded adaptor with brass insert – MAB



Size mm x inch	Designation	Polypropylene homopolymer Product No.
20 x 1/2"	MALE THREADED ADAPTOR WITH BRASS INSERT (MAB) 20 x 1/2"	0796 2651 119
25 x 3/4"	MALE THREADED ADAPTOR WITH BRASS INSERT (MAB) 25 x 3/4"	0796 2651 123
25 x 1"	MALE THREADED ADAPTOR WITH BRASS INSERT (MAB) 25 x 1"	0796 2651 125
32 x 1"	MALE THREADED ADAPTOR WITH BRASS INSERT (MAB) 32 x 1"	0796 2651 129

Female threaded adaptor with brass insert – FAB



Size mm x inch	Designation	Polypropylene homopolymer Product No.
20 x 1/2"	FEMALE THREADED ADAPTOR WITH BRASS INSERT (FAB) 20 x 1/2"	0796 2651 017
25 x 3/4"	FEMALE THREADED ADAPTOR WITH BRASS INSERT (FAB) 25 x 3/4"	0796 2651 024
25 x 1"	FEMALE THREADED ADAPTOR WITH BRASS INSERT (FAB) 25 x 1"	0796 2651 027
32 x 1"	FEMALE THREADED ADAPTOR WITH BRASS INSERT (FAB) 32 x 1"	0796 2651 032

Female threaded bend with brass insert – FBB



Size mm x inch	Designation	Polypropylene homopolymer Product No.
20 x 3/4"	FEMALE THREADED BEND WITH BRASS INSERT (FBB) 20 x 3/4"	0796 2651 053
25 x 3/4"	FEMALE THREADED BEND WITH BRASS INSERT (FBB) 25 x 3/4"	0796 2651 058
32 x 1"	FEMALE THREADED BEND WITH BRASS INSERT (FBB) 32 x 1"	0796 2651 067



- 1 Torx screw with integrated washer**
– makes installation and removal easier
- 2 Band adapted to fit ball-shaped flange connections**
– system works in perfect harmony
- 3 Free from chromium(VI); easy-slide coating**
– improved clamping force
- 4 Solid trunnion, chromium(VI)-free coating**
– high temperature resistance, maintains high clamping force levels

Ball zone exhaust gas clamps

NORMACONNECT® SEC ball zone exhaust gas clamps are the ideal solution when it comes to making connections in central and rear exhaust gas areas. When used in conjunction with flange joints, it is possible to swivel silencers during installation.

Advantages at a glance

- Angle compensation in exhaust gas system
- Silencers can be swiveled during installation
- Installation and removal conditions easier to work with thanks to increased flexibility of overall system
- Higher torsion moments than conventional ball-shaped flange connections
- Low leakage rate
- Low weight

Applications

- Agricultural machines
- Building Machines
- Engine manufacturing

Materials

W1	W2	W3	W4	W5
	x			
Material	Corrosion resistance in salt spray testing			
W2	Min. 96 h			

Bolts

The scope of delivery does not include fastening bolts or nuts. Sizes M8 or M10 are required.

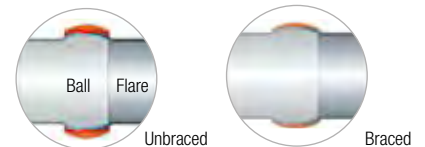

Technical data & Ordering information

NORMACONNECT® SEC					
Designation	Pipe diameter Inner		Clamping diameter in mm	Flange radius	W2 Product No.
	in mm	in inches			
SEC 55	55	2 3/16	65	32.5	0595 0312 055
SEC 60	60	2 3/8	69.5	35	0595 0312 060
SEC 65	65	2 9/16	75	37.6	0595 0312 065
SEC 70	70	2 3/4	81.5	40.2	0595 0312 070

Additional diameters on request



- 1 M8, M10 & M12 bolts available as alternatives**
– depending on clamping force requirements
- 2 Clamp band in one piece**
– contact surface meets pipe consistently
– even contact pressure over the entire pipe circumference
– excellent sealing properties
- 3 Single-bolt closure**
– easy installation
- 4 Rounded band edges**
– pipe protection
– prevents risk of injuries

Exhaust pipe clamps

ARS exhaust pipe clamps provide a secure, reliable connection for pipes that are fitted into one another, even those that are subject to significant temperature fluctuations. As such, they are particularly suitable for connecting exhaust pipes and silencers in the automotive industry.



Advantages at a glance

- One piece
- Contact surface meets pipe consistently
- Even contact pressure over entire pipe circumference
- No risk of asymmetrical pipe deformation

Applications

- Agricultural machines
- Building machines
- Engine manufacturing

Materials

W1	W2	W3	W4	W5
x	x*		x*	x*

* On request.

Material	Corrosion resistance in salt spray testing
W1	Min. 144 h

Bolts

Bolt	Hammer head bolt/Flange nut	Hexagon-head bolt/Flange nut	Hexagon-head bolt/Hexagon	Loose washer *
M8	X	X		X **
M10			X	X
M12			X	X

* Under bolt head and under bolt nut.

** Under bolt head (select nominal diameters only).



M8 version with hammer head bolt.



M10 and M12 version with hexagon-head bolt.



Technical data & Ordering information

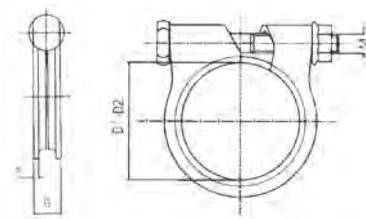

NORMACONNECT® ARS						
Designation	Clamping ranges D1–D2 in mm	S	B	Recommended tightening torque	W1 Product No.	
ARS-M8-27	24-27	1.5	10.4	8–10 Nm	0151 8939 027	
ARS-M8-33	30-33	1.5	10.4		0151 8939 033	
ARS-M8-36	33-36	2.0	12.8	10–15 Nm	0151 8940 036	
ARS-M8-39.5	36.5-39.5	2.0	12.0		0151 8940 040	
ARS-M8-42	39-42	2.0	12.8		0151 8940 042	
ARS-M8-45	42-45	2.5	13.6		0151 8941 045	
ARS-M8-46	43-46	2.5	12.8	15-20 Nm	0151 8941 046	
ARS-M8-47	44-47	2.5	13.6		0151 8941 047	
ARS-M8-48	45-49	2.5	13.2		0151 8941 048	
ARS-M8-49	48-51	2.5	13.2		0151 8941 049	
ARS-M8-50.5	51-54	2.5	13.2		0151 8941 505	
ARS-M8-51	52-55	2.5	13.2		0151 8941 051	
ARS-M8-54	55-58	2.5	13.2		0151 8941 054	
ARS-M8-55	55-58	2.5	13.6		0151 8941 055	
ARS-M8-58	61-64	2.5	13.2		0151 8941 058	
ARS-M8-64	63-66	2.5	13.2		0151 8941 064	
ARS-M8-71	68-71	2.5	13.2		35-40 Nm	0151 8941 071
ARS-M10-71	67-71.5	3.0	13.2			0161 8939 071
ARS-M12-114	106-114	3.0	19.0	0181 8079 114		
ARS-M12-145	137.5-144.5	3.0	19.0	0181 8941 145		



- 1 Option of attaching a lug**
– clamp can also function as a fixing clip or retaining clamp
- 2 Clamp supplied without bolts**
– bolts can be selected individually
- 3 Straightforward clamp structure**
– pipe protection
– easy to handle

Exhaust pipe clamps in accordance with DIN 71555

NORMACONNECT® RS/DIN exhaust pipe clamps are an alternative to NORMACONNECT® ARS clamps. They ensure an equally secure connection for pipes that are fitted into one another. Additionally, the straightforward clamp structure of the RS/DIN version allows a lug to be attached to it, meaning that it can also be used as a fixing clip.

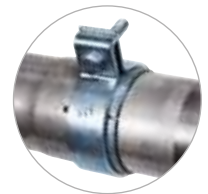

Advantages at a glance

- Safe system for connecting pipes that are fitted to one another
- Can also be used as a fixing clip or retaining clamp
- In accordance with DIN 71555

Applications

- Agricultural machines
- Building machines
- Engine manufacturing

Materials

W1	W2	W3	W4	W5
x		x *	x *	x *

* On request.

Material	Corrosion resistance in salt spray testing
W1	Min. 144 h

Bolts

The scope of delivery does not include fastening bolts or nuts. Sizes M8 or M10 are required.

Technical data & Ordering information

NORMACONNECT® RS/DIN				
Band width	Designation	Clamping diameter in mm	W1 Product No.	
20	RS 30.2 DIN 71555	30.2	0550 7000 030	
	RS 32.2 DIN 71555	32.2	0550 7000 032	
	RS 35.2 DIN 71555	35.2	0550 7000 035	
	RS 37.2 DIN 71555	37.2	0550 7000 037	
25	RS 40.3 DIN 71555	40.3	0550 7000 040	
	RS 42.3 DIN 71555	42.3	0550 7000 042	
	RS 45.5 DIN 71555	45.5	0550 7000 045	
	RS 48.5 DIN 71555	48.5	0550 7000 048	
	RS 50.5 DIN 71555	50.5	0550 7000 050	
	RS 53.5 DIN 71555	53.5	0550 7000 053	
	RS 55.5 DIN 71555	55.5	0550 7000 055	
	RS 58.5 DIN 71555	58.5	0550 7000 058	
	RS 60.5 DIN 71555	60.5	0550 7000 060	
	RS 63.5 DIN 71555	63.5	0550 7000 063	
	RS 65.5 DIN 71555	65.5	0550 7000 065	
	RS 68.5 DIN 71555	68.5	0550 7000 068	
	30	RS 70.5 DIN 71555	70.5	0550 7000 070
		RS 73.5 DIN 71555	73.5	0550 7000 073
RS 75.5 DIN 71555		75.5	0550 7000 075	
RS 78.5 DIN 71555		78.5	0550 7000 078	
RS 85.5 DIN 71555		85.5	0550 7000 085	
RS 89.5 DIN 71555		89.5	0550 7000 089	
RS 90.5 DIN 71555		90.5	0550 7000 090	
RS 94.5 DIN 71555		94.5	0550 7000 094	
RS 100.5 DIN 71555		100.5	0550 7000 100	
RS 104.5 DIN 71555		104.5	0550 7000 104	
RS 110.5 DIN 71555		110.5	0550 7000 110	



- 1 High-strength fastener hardware with corrosion-resistant coating
- 2 Easy to assemble, only one assembly torque point
- 3 Smooth band

Unique seal clamp

The AccuSeal offers an innovative reaction block technology to provide a full 360 degree equal distribution of stretching force, prohibiting pipe distortion while completing a unique seal around the joined exhaust components with high clamp load. The exhaust connections are serviceable and easy to disassemble.



Advantages at a glance

- Simple, effective way to connect exhaust system components
- Unique seal and high clamp loads are provided without permanent distortion to exhaust members
- Provides joint serviceability
- Durable installation without damage to pipe ends
- Designed for part-in-assembly attachment
- Superior clamp load capability

Applications

- For connecting exhaust system components
- Assembled, serviceable joint for use on all slotted rigid pipe
- Pipes, mufflers and converters

Materials

W1	W2	W3	W4	W5
x		x		

Information

- Features 47.0 mm (1.85") band up to 70.6 mm (2.78")

Technical data & Ordering information

NORMACONNECT® ACCUSEAL				
Description	Clamping range		W1 Product No.	W3 Product No.
	in mm	in inches		
ACCUSEAL 47.0	47.0	1.85		0366 6100 470
ACCUSEAL 47.6	47.6	1.87		0366 6100 476
ACCUSEAL 50.0	50.0	1.97	0366 6100 500	0366 6120 500
ACCUSEAL 50.6	50.6	1.99	0366 6110 506	0366 6100 506
ACCUSEAL 52.0	52.0	2.05		0366 6100 520
ACCUSEAL 53.0	53.0	2.09		0366 6100 530
ACCUSEAL 53.6	53.6	2.11	0366 6120 536	0366 6110 536
ACCUSEAL 53.6	53.6	2.11		0366 6100 536
ACCUSEAL 54.9	54.9	2.16	0366 6120 549	0366 6100 549
ACCUSEAL 55.5	55.5	2.19		0366 6100 555
ACCUSEAL 55.6	55.6	2.19		0366 6130 556
ACCUSEAL 55.6	55.6	2.19		0366 6140 556
ACCUSEAL 55.7	55.7	2.19		0366 6110 557
ACCUSEAL 56.0	56.0	2.20	0366 6100 560	
ACCUSEAL 56.4	56.4	2.22	0366 6100 564	0366 6110 564
ACCUSEAL 57.6	57.6	2.27		0366 6110 576
ACCUSEAL 58.7	58.7	2.31		0366 6110 587
ACCUSEAL 59.2	59.2	2.33		0366 6000 592
ACCUSEAL 59.4	59.4	2.34	0366 6110 594	0366 6120 594
ACCUSEAL 59.7	59.7	2.35		0366 6100 597
ACCUSEAL 60.0	60.0	2.36		0366 6110 600
ACCUSEAL 60.3	60.3	2.37		0366 6110 603
ACCUSEAL 60.5	60.5	2.38		0366 6100 605
ACCUSEAL 60.6	60.6	2.39		0366 6110 606
ACCUSEAL 61.4	61.4	2.42	0366 6100 614	
ACCUSEAL 61.6	61.6	2.43		0366 6100 616
ACCUSEAL 62.1	62.1	2.44	0366 6140 621	0366 6110 621
ACCUSEAL 62.3	62.3	2.45		0366 6100 623
ACCUSEAL 62.9	62.9	2.48	0366 6100 629	0366 6120 629
ACCUSEAL 64.9	64.9	2.56	0366 6100 649	0366 6110 649
ACCUSEAL 65.3	65.3	2.57		0366 6100 653
ACCUSEAL 65.6	65.6	2.58	0366 6100 656	0366 6110 656
ACCUSEAL 66.8	66.8	2.63		0366 6120 668
ACCUSEAL 68.4	68.4	2.69		0366 6100 684
ACCUSEAL 68.9	68.9	2.71	0366 6100 689	
ACCUSEAL 69.1	69.1	2.72		0366 6100 691
ACCUSEAL 69.4	69.4	2.73	0366 6100 694	
ACCUSEAL 69.7	69.7	2.74		0366 6100 697
ACCUSEAL 69.9	69.9	2.75		0366 6110 699
ACCUSEAL 70.6	70.6	2.78	0366 6110 706	0366 6120 706

NORMACONNECT®

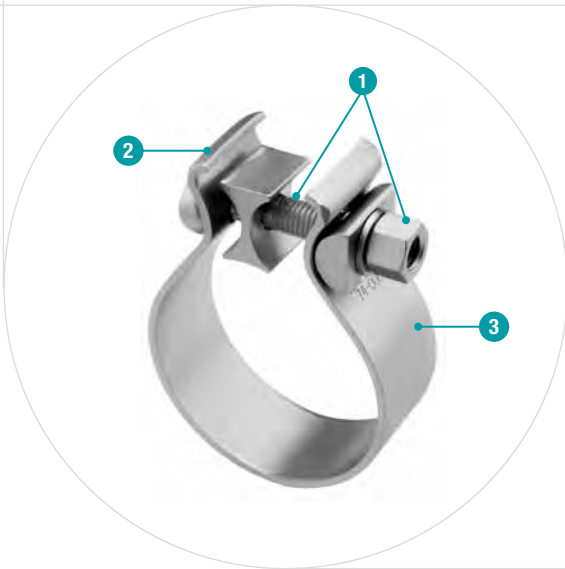

- 1 High-strength fastener hardware with corrosive resistant coating
- 2 Improved clamp performance for thicker pipes on larger pipe gaps
- 3 Easy to assemble, only one assembly torque point

Extra seal clamp

The DuraSeal offers extra seal and clamp load performance to meet or exceed durability requirements without permanent distortion to exhaust members. Designed for applications with thicker pipe walls and larger pipe assembly gaps, it is ideal for applications with limited packaging space.



Advantages at a glance

- Exclusive reaction block provides a full 360° distribution
- Simple, effective way to connect exhaust system components
- Designed for part-in-assembly pre-attachment
- Pre-assembled for easy installation
- Provides joint serviceability; no permanent distortion

Applications

- For high durability requirements
- Improved clamp performance for applications with thicker pipe walls and larger pipe assembly gaps
- Ideal for applications with limited packaging space
- Pipes, mufflers and converters

Materials

- 409 stainless steel
- 304 stainless steel (on request)

Information

- Diameter range: 50.8 mm (2") up to 127 mm (5")
- 7.9 mm (5/16") slotted hex screw

Technical data & Ordering information

NORMACONNECT® DURASEAL			
Designation	Diameters		409 Stainless Steel Product No.
	in mm	in inches	
DURASEAL 50.8	50.8	2	0371 0001 056
DURASEAL 57.15	57.15	2.25	0371 0001 062
DURASEAL 63.5	63.5	2.5	0371 0003 068
DURASEAL 69.85	69.85	2.75	0371 0003 075
DURASEAL 76.2	76.2	3	0371 0004 081
DURASEAL 88.9	88.9	3.5	0371 0000 093
DURASEAL 101.6	101.6	4	0371 0001 107
DURASEAL 114.3	114.3	5	0371 0000 132



- 1 Provides OE with a robust design alternative to flat flange
- 2 Provides rotational and axial alignment flexibility

Robust alternative clamp

The AccuLock exhaust clamp provides a robust alternative to flat flanges with enhanced assembly flexibility, lower weight and improved overall value. Designed for use in low leak, pre-after treatment (catalyst) applications. Uses less space than a flat flange joint and has positive axial retention.

Advantages at a glance

- Enhanced assembly flexibility, lower weight, improved overall value
- Positive axial retention
- Uses less space than a flat flange joint

Applications

- Designed for use in low leak, pre-after treatment (catalyst) applications

Materials

- Aluminized steel
- 409 stainless steel
- 430 stainless steel

Information

- Available in standard industry sizes from 45 mm (1 - 1/4") up to 127 mm (5")

Technical data & Ordering information

NORMACONNECT® ACCULOCK					
Designation	Diameters		Aluminized Steel Product No.	409 Stainless Steel Product No.	430 Stainless Steel Product No.
	in mm	in inches			
ACCULOCK 88.9	88.9	3.5	0370 0002 089	0370 0000 089	
ACCULOCK 55	55	2.2	0370 0000 055		
ACCULOCK 63.5	63.5	2.5	0370 0001 064		
ACCULOCK 336.8	336.8	13.3			0370 0001 337
ACCULOCK 362.2	362.2	14.3			0370 0001 362
ACCULOCK 387.6	387.6	15.3			0370 0001 388



- 1 High-strength fastener hardware with corrosion-resistant coating
- 2 Exclusive reaction block
- 3 Indexed interior band provides a superior joint seal

Joining exhaust system components

The Coupler is an effective way to join exhaust system components without the need for pipe flares/slip joints or slotting. This clamp offers superior clamp load capability and a serviceable joint. Allows for quick assembly and service of exhaust pipes. It provide significant resistance to longitudinal and rotational movement of pipes.

Advantages at a glance

- No need for pipe sizing or slotting
- Provides a serviceable joint. No permanent distortion of exhaust members
- No loose hardware
- Allows assembly & service without longitudinal movement of pipe members
- Overall width 87.95mm
- Does not require pipe overlap
- Eliminated the need for sizing and slotting of pipe members

Applications

- Effective alternative for joining high performance exhaust components

Materials

W1	W2	W3	W4	W5
		x		

Information

- Features 38 mm (1.50") diameter up to 65 mm (2.56")
- 15 mm fastener drive

Technical data & Ordering information

NORMACONNECT® COUPLER			
Description	Clamping range		W3 Product No.
	in mm	in inches	
COUPLER 38	38	1.50	0367 6102 038
COUPLER 42	42	1.65	0367 6100 042
COUPLER 45	45	1.77	0367 6102 045
COUPLER 50	50	1.97	0367 6100 050
COUPLER 55	55	2.17	0367 6100 055
COUPLER 60	60	2.36	0367 6100 060
COUPLER 65	65	2.56	0367 6100 065



- 1 Unique designed slots provide optimal seal and joints retention performance
- 2 Unique fastening system stretches the band using its tensile strength permitting the use of thinner gauge, corrosive resistant materials

Pipe based coupler

The NORMACONNECT® AccuSeal Coupler is a pipe-based coupler that is flexible in both length and diameter. With its unique seal and high clamp loads, permanent distortion to exhaust members is prevented.

Advantages at a glance

- Exclusive reaction block provides a 360 equal distribution of stretching forces, prohibiting pipe distortion while completing a seal around the joined exhaust components
- Efficient use of materials reduces weight and assembly costs

Applications

- Pipes, mufflers and converters

Materials

- 409 stainless steel
- 304 stainless steel

Technical data & Ordering information

NORMACONNECT® ACCUSEAL COUPLER				
MALE - OD mm	FEMALE ID		Ferritic	Austenitic
45	45.3	45.8	ALZ 45	304 45
50	50.3	50.8	ALZ 50	304 50
55	55.3	55.8	ALZ 55	304 55
60	60.3	60.8	ALZ 60	304 60
65	65.3	65.8	ALZ 65	304 65
70	70.3	70.8	ALZ 70	304 70
75	75.3	75.8	ALZ 75	304 75
80	80.3	80.8	ALZ 80	304 80
85	85.3	85.8	ALZ 85	304 85
90	90.3	90.8	ALZ 90	304 90

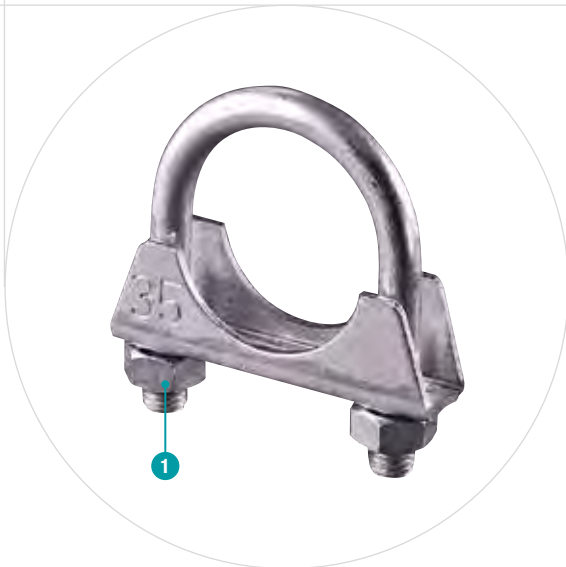

1 Pre-mounted screw and nuts

Exhaust system pipe clamp

The NORMACONNECT® Pipe clamp M8 meets quality standards, which are suitable for use with a wide range of pipe diameters. Pipe clamps are not used only in exhaust systems.

Advantages at a glance

- Hexagonal wheel for better maintenance of the U
- Completely assembled
- Suitable for use with a wide range of pipe diameters

Applications

- Exhaust systems
- Mounting of signage
- TV antennas/aerials

Materials

W1	W2	W3	W4	W5
x				

Technical data & Ordering information

NORMACONNECT® PIPE CLAMP M8						
Designation	Diameter in mm	A± 0.7	B	C	E± 1	W1 Product No.
PIPE CLAMP M8 25	25	50	16	25	52	0152 0000 025
PIPE CLAMP M8 28	28	53	17.5	28	54	0152 0000 028
PIPE CLAMP M8 32	32	57	19	32	60	0152 0000 032
PIPE CLAMP M8 35	35	60	20	35	63	0152 0000 035
PIPE CLAMP M8 38	38	63	22	38	65	0152 0000 038
PIPE CLAMP M8 42	42	67	23.5	42	69	0152 0000 042
PIPE CLAMP M8 45	45	70	25.5	45	71	0152 0000 045
PIPE CLAMP M8 48	48	73	26	48	73	0152 0000 048
PIPE CLAMP M8 51	51	76	26.5	51	76	0152 0000 051
PIPE CLAMP M8 54	54	79	28	54	79	0152 0000 054
PIPE CLAMP M8 57	57	82.5	29	57	83	0152 0000 057

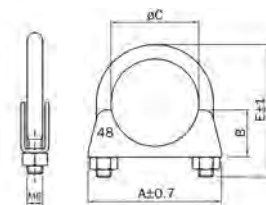

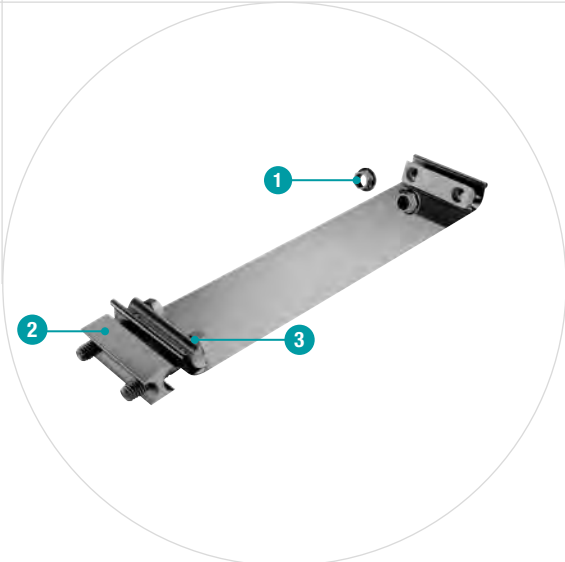

- 1 High-strength, plated Grade 8 fasteners
- 2 The original invented reaction block technology creates a complete “inner circle seal” when clamp is secured
- 3 Pre-attached hardware for fast, easy and accurate installation

Wide band exhaust clamps

The EasySeal offers the best value in wideband exhaust clamps. Used for joining exhaust members of the same diameter. The unique design makes for fast, easy and accurate installation.

Advantages at a glance

- Patented design makes for fast, easy and accurate installation - there's no need to separate pipes or exhaust members before clamping
- Replaced U-bolts and clamps
- With pre-attached hardware
- Ideal, service specific design
- Flat, packaged, easy to store
- Easy, fast, accurate installation
- Unique sealing performance
- Durable installation without damage to pipe ends

Applications

- To connect exhaust system components

Materials

- Band in bright finish stainless steel or matt finish aluminized carbon steel.

Information

- Available in standard industry sizes from 50.8 mm (2") up to 203.2 mm (8")

Technical data & Ordering information

NORMACONNECT® EASYSEAL			
Designation	Diameters		409 Stainless Steel Product No.
	in mm	in inches	
EASYSEAL 50.8	50.8	2	0368 0000 051
EASYSEAL 57.15	57.15	2.25	0368 0000 056
EASYSEAL 63.5	63.5	2.5	0368 0000 064
EASYSEAL 69.85	69.85	2.75	0368 0000 069
EASYSEAL 76.2	76.2	3	0368 0000 076
EASYSEAL 88.9	88.9	3.5	0368 0000 089
EASYSEAL 101.6	101.6	4	0368 0000 102
EASYSEAL 114.3	114.3	5	0368 0000 114
EASYSEAL 127	127	5	0368 0000 127
EASYSEAL 152.4	152.4	6	0368 0000 152
EASYSEAL 177.8	177.8	7	0368 0000 178
EASYSEAL 203.2	203.2	8	0368 0000 203



- 1 Bridge**
 - good hose/sleeve coverage
- 2 Design protects hoses/sleeves**
 - clamping force is distributed across a wide area
 - prevents damage to components being clamped
 - excellent transverse rigidity

Wide-band hose clamps in accordance with DIN 3017-5

Used in conjunction with a rubber sleeve, BRS wide-band hose clamps are the ideal choice for connecting pipes with smooth ends. They connect cast iron and steel pipes just as securely as plastic or glass pipes and without any welding.

NORMACONNECT® wide-band hose and retaining clamps are produced with standardized band widths and materials. The progressive ratio is 1 mm in the case of a single-part version. Up to a clamping diameter of 300 mm, the clamps are supplied in rolled-up form. With clamping diameters of 301 mm and up, they are supplied in stretched-out form.

Advantages at a glance

- Extremely wide band
- Clamping force distributed over a large area
- High level of transverse rigidity
- Single-part and multi-part versions

Applications

- Machine building
- White goods
- Food and beverage industry
- Agricultural machines
- Engine manufacturing
- Exhaust air technology
- Suction systems
- Laboratory technology
- Drainage technology

Materials

W1	W2	W3	W4	W5
	x		x	

Material	Corrosion resistance in salt spray testing
W2	Min. 72 h
W4	Min. 240 h

Bolts

NORMACONNECT® BRS		
Band width	Sz in the case of W2	Sk in the case of W4
48	M6 x 38 Sz	M6 x 45 Sk
54	M8 x 47 Sz	M8 x 50 Sk
65	M8 x 47 Sz	M8 x 50 Sk

Technical data

NORMACONNECT® BRS				
Band width in mm	Minimum diameter in mm	Static tightening torque in Nm	Material thickness in mm	
			W2	W4
48	50	4	0.4	0.5
54	50	12	0.4	0.5
65	50	12	0.4	0.5

Ordering information

	1. Type	2. Clamping range	3. Band width	4. Material	5. Bolt
Example	BRS	55	48	W2	Sz



- 1 **Cover band**
– optimum distribution of clamping forces
- 2 **Closure**
- 3 **3 profile segments**
– ease of assembly



The SSVS STC-type closure is a cost effective alternative to conventional T-bolt closures.

Profile clamp with cover band

The V profile clamps are reliable and time-effective connection elements for industrial and automotive use. They are made to customer requirements and can be supplied with various profiles, band widths and closure types.

Advantages at a glance

- Low friction losses
- Robust precision components
- Consistently high material quality
- State-of-the-art automated manufacturing
- Highly competitively priced

Applications

- Automotive: Turbocharger – catalytic converter connection
- Automotive: Exhaust manifold
- Industry: Bulk material container
- Industry: Bypass filter unit

Materials

NORMACONNECT® SSVS profile clamps are available in three material specifications:

Code	Closures			Closure components	Profile segments/ Cover band
	STC	QRC	SVS		
W2	•		•	Mild steel, zinc plated	Stainless steel
W4	•	•	•	Stainless steel	

ISO	DIN	AISI	BS	AFNOR
X5 CrNi 18-10	1.4301	304	304 S 15	Z6 CN 18-09

Product's method of operation

The profile clamp's method of operation is based on the principle of an inclined plane. When the closure bolt is tightened, this exerts circumferential force on the profile segments. The two halves of the flange are pressed together by means of the profile (see diagram below). The circumferential force that is exerted is converted into considerably higher axial force.

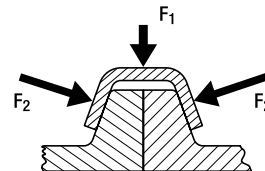

All profiles at a glance

Single-part 3 profile segments
Available up to diameter 300 mm

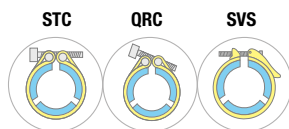

Two-part 2 profile segments
Available from diameter 200 mm up to 500 mm



Example of flange designs

Use of gasket may be required in some applications. Support and advice on gasket selection can be provided.

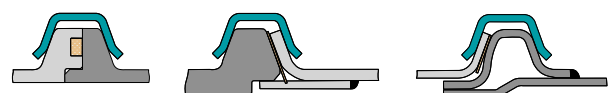

Profile types

4.0 b		≥ ø 89		5.0 a		≥ ø 82		5.3 b		≥ ø 110		6.0 a		≥ ø 125	
	20 mm		25 mm		20 mm		25 mm		20 mm		25 mm		20 mm		25 mm
STC	•			STC	•			STC	•			STC	•		
QRC	•			QRC	•			QRC	•			QRC	•		
SVS	•			SVS	•			SVS	•			SVS	•		
6.6 b		≥ ø 100		9.2 a		≥ ø 100		10.2 a		≥ ø 130		14.5 a		≥ ø 105	
	20 mm		25 mm		20 mm		25 mm		20 mm		25 mm		20 mm		25 mm
STC	•			STC		•		STC		•		STC		•	
QRC	•			QRC		•		QRC		•		QRC		•	
SVS	•			SVS		•		SVS		•		SVS		•	

The inner profile diameter can be freely selected in millimeter increments. All profiles can be supplied with a diameter of up to ø 500 mm. Please refer to the relevant profile diagram in the table below to find out the minimum diameter permissible for that profile.

Profile clamps can be supplied with cover bands measuring 20 mm or 25 mm in width.

The table above indicates which cover band is suitable for which profile.

Examples of flange structures

Inner profile ø		Flange 1				Flange 2				Flange 3				Flange 4			
Profile type	Profile ø (mm)	W (mm)	H (mm)	R (mm)	T (mm)	W (mm)	H (mm)	R (mm)	T (mm)	W (mm)	H (mm)	R (mm)	T (mm)	W (mm)	H (mm)	R (mm)	T (mm)
4.0b	≥ 100	5.1	7.5	5.1	8	2	2	5.1	7.5	1	1	Not recommended					
5.0a	≥ 100	6.1	4.6	6.1	4.6	1.5	1.5	6.1	4.6	1	1	6.1	4.6	1.5	1.5		
5.3b	≥ 110	6.4	7.3	6.4	7.8	2	2	6.4	7.3	1.5	1.5	6.4	7.8	2	2		
6.0a	≥ 125	7.1	4	7.1	4	1.5	1.5	Not recommended				7.1	4	1.5	1.5		
6.5a	≥ 130	7.6	8.3	7.6	8.8	2	2	7.6	8.3	1.5	1.5	7.6	8.8	2	2		
6.6b	≥ 100	7.7	6.6	7.7	6.6	1.5	1.5	7.7	6.6	1.5	1.5	7.7	6.6	1.5	1.5		
7.9b	≥ 100	9	5.7	9	6.2	2	2	9	5.7	1.5	1.5	9	6.2	2	2		
9.2a	≥ 100	10.3	7.3	10.3	7.8	2	2	10.3	7.8	2	2	10.3	7.8	2	2		
10.2a	≥ 130	11.3	7.3	11.3	7.8	2	2	11.3	7.8	2	2	11.3	7.8	2	2		
14.5a	≥ 105	15.6	7.4	15.6	7.9	2	2	15.6	7.9	2	2	Not recommended					
Abbreviations:		W = overall flange width		H = overall flange height		R = flange radius		T = flange thickness									

Technical information

Profile type	Profile ϕ (mm)	Performance (stainless steel only)	Technical information													
5.0 a 6.0a 6.6b	≥ 100 ≥ 125 ≥ 100	<p>Profile 1mm</p>	<ol style="list-style-type: none"> Determine the application or test pressure. Determine the max. operating temperature to which the profile clamp will be exposed. (Note: The profile clamps presented in this brochure have been designed for a maximum operating temperature of 400°C.) Calculate the required inner diameter of the profile as follows: outer flange diameter + 3 mm Using the diagrams on the left. Check whether the profile thickness you have selected will be sufficient. (Note: The result only represents an initial approximation based on static pressures and ideal operating conditions.) <p>Other factors may come into play, such as:</p> <ul style="list-style-type: none"> • Shape and material used for sealing measures • Roughness of flange surface • Operating temperatures • Bending moments • Pressure surges/Vibrations • Safety requirements <p>Based on these factors, you may decide that a thicker profile is necessary. The SVS closure is only recommended for low pressures (e.g., vacuum applications).</p> <p>5. The tables below provide information on the tightening torques for the various closure types and bolt sizes.</p> <p>5.1. Recommended tightening torque for STC & QRC-type closures:</p> <table border="1"> <thead> <tr> <th>Band width</th> <th>Bolt</th> <th>Tightening torque</th> </tr> </thead> <tbody> <tr> <td>20 mm</td> <td>M 6</td> <td>6 Nm</td> </tr> <tr> <td>25 mm</td> <td>M 8</td> <td>12 Nm</td> </tr> </tbody> </table> <p>5.2 SVS closing force:</p> <table border="1"> <thead> <tr> <th>Bolt</th> <th>Force</th> </tr> </thead> <tbody> <tr> <td>M 6</td> <td>≈ 80 Nm</td> </tr> </tbody> </table> <p>Example of application:</p> <ul style="list-style-type: none"> • Operating pressure: 4 bar (static) • Temperature: 20 °C • Profile type: 4.0b • Profile thickness: 1,5 mm • Flange diameter: ϕ 197 mm • Inner profile diameter: ϕ 200 <p>Max. permissible pressure at 20 °C:</p> <ul style="list-style-type: none"> • 5,4 bar > 4 bar -OK 	Band width	Bolt	Tightening torque	20 mm	M 6	6 Nm	25 mm	M 8	12 Nm	Bolt	Force	M 6	≈ 80 Nm
Band width	Bolt	Tightening torque														
20 mm	M 6	6 Nm														
25 mm	M 8	12 Nm														
Bolt	Force															
M 6	≈ 80 Nm															
4.0b 5.3b 7.9b 14.5a	≥ 100 ≥ 110 ≥ 100 ≥ 105	<p>Profile 1.5mm</p>														
6.5a 9.2a 10.2a 11.4b	≥ 130 ≥ 100 ≥ 130 ≥ 180	<p>Profile 2.0mm</p>														
9.2 b	≥ 155	<p>Profile 3.0mm</p>														

NORMACONNECT® V profile clamps are manufactured in two different band widths and with different closures, depending on the profile type concerned:

Closure type	Cover band 1.0 x 20 mm	Cover band 1.5 x 25 mm
STC	Bolt M 6 x 50	Bolt M 8 x 70
QRC		
SVS	Bolt M 6 x 70	Bolt M 6 x 70

Technical data & Ordering information

NORMACONNECT® V STC			
Min. profile type	Profile Ø (mm)	W2	W4
		Product No.	Product No.
		STC	STC
4.0b	≥ 89	0611 1043 ...	0611 2043 ...
5.0a	≥ 82	0611 1032 ...	0611 2032 ...
5.3b	≥ 110	0611 1078 ...	0611 2078 ...
6.0a	≥ 125	0611 1004 ...	0611 2004 ...
6.5a	≥ 130	0611 3015 ...	0611 4015 ...
6.6b	≥ 100	0611 1031 ...	0611 2031 ...
7.9b	≥ 100	0611 1099 ...	0611 2099 ...
9.2a	≥ 100	0611 3009 ...	0611 4009 ...
10.2a	≥ 130	0611 3081 ...	0611 4081 ...
14.5a	≥ 105	0611 3028 ...	0611 4028 ...

Single-part design • 3 segments • Cover band • Inner profile diameter Ø ≤ 300 mm
 " ... = Ø without decimals in mm "

NORMACONNECT® V STC		
Profile type	W2	W4
	Product No.	Product No.
	STC	STC
4.0b	0609 1043 ...	0609 2043 ...
5.0a	0609 1032 ...	0609 2032 ...
5.3b	0609 1078 ...	0609 2078 ...
6.0a	0609 1004 ...	0609 2004 ...
6.5a	0609 3015 ...	0609 4015 ...
6.6b	0609 1031 ...	0609 2031 ...
7.9b	0609 1099 ...	0609 2099 ...
9.2a	0609 3009 ...	0609 4009 ...
10.2a	0609 3081 ...	0609 4081 ...
14.5a	0609 3028 ...	0609 4028 ...

Two-part version* • 2 segments • No cover band • Inner profile diameter Ø 200 - 500 mm
 " ... = Ø without decimals in mm "

Application areas

NORMACONNECT® V profile clamps are quick-release connecting elements for flanges and represent an economical alternative to conventional bolted flange connections.



Automotive: Turbocharger – catalytic converter connection



Automotive: Exhaust manifold



Industry: Bulk material container



Industry: Bypass filter unit

QRC



The revolutionary new QRC-type closure offers significant advantages over conventional T-bolt solutions.

Advantages at a glance

- Rapid closing and opening
- Captive closure components
- Significantly shorter installation
- Closure bolt secured during tightening

Materials

- W4

NORMACONNECT® V QRC		
Min. profile type	Profile Ø (mm)	W4 Product No.
		QRC
4.0b	≥ 89	0615 2043 ...
5.0a	≥ 82	0615 2032 ...
5.3b	≥ 110	0615 2078 ...
6.0a	≥ 125	0615 2004 ...
6.5a	≥ 130	0615 4015 ...
6.6b	≥ 100	0615 2031 ...
7.9b	≥ 100	0615 2099 ...
9.2a	≥ 100	0615 4009 ...
10.2a	≥ 130	0615 4081 ...
14.5a	≥ 105	0615 4028 ...

Single-part design • 3 segments • Cover band • Inner profile diameter Ø ≤ 300 mm
 " ... = Ø without decimals in mm "

SVS



The SVS type includes an over-center lever which enables manual installation.

Advantages at a glance

- Installation without tools
- Ideal for frequent handling

Materials

- W2, W4

NORMACONNECT® V SVS			
Min. profile type	Profile Ø (mm)	W2 Product No.	W4 Product No.
		SVS	SVS
4.0b	≥ 89	0607 1043 ...	0607 2043 ...
5.0a	≥ 82	0607 1032 ...	0607 2032 ...
5.3b	≥ 110	0607 1078 ...	0607 2078 ...
6.0a	≥ 125	0607 1004 ...	0607 2004 ...
6.5a	≥ 130	0607 3015 ...	0607 4015 ...
6.6b	≥ 100	0607 1031 ...	0607 2031 ...
7.9b	≥ 100	0607 1099 ...	0607 2099 ...
9.2a	≥ 100	0607 3009 ...	0607 4009 ...
10.2a	≥ 130	0607 3081 ...	0607 4081 ...
14.5a	≥ 105	0607 3028 ...	0607 4028 ...

Single-part design • 3 segments • Cover band • Inner profile diameter Ø ≤ 300 mm
 " ... = Ø without decimals in mm "

NORMACONNECT® V SVS		
Profile type	W2 Product No.	W4 Product No.
	SVS	SVS
4.0b	0605 1043 ...	0605 2043 ...
5.0a	0605 1032 ...	0605 2032 ...
5.3b	0605 1078 ...	0605 2078 ...
6.0a	0605 1004 ...	0605 2004 ...
6.5a	0605 3015 ...	0605 4015 ...
6.6b	0605 1031 ...	0605 2031 ...
7.9b	0605 1099 ...	0605 2099 ...
9.2a	0605 3009 ...	0605 4009 ...
10.2a	0605 3081 ...	0605 4081 ...
14.5a	0605 3028 ...	0605 4028 ...

Two-part version* • 2 segments • No cover band • Inner profile diameter Ø 200 - 500 mm
 " ... = Ø without decimals in mm "

NORMAFIX® – Retaining Products

Versatile products for a whole host of applications

The NORMAFIX® range of clamps, clips and systems for retaining pipes, cables, cable harnesses and hoses are ready for action wherever they're needed – walls, ceilings or car bodies.





Smooth round edges

– easier to handle and safer to install

Variety of colors

– available in: black, white, red, yellow, green, blue

“Carbon Black” added in Black cable tie flange

– increased resistance to UV rays

– suitable for outdoor use

Quick and safe securing of cables in material PA 6.6

Cable tie for securing cables in electrical installations, industrial wiring, automotive, etc. Made of polyamide 6.6. Resistant to extreme temperatures and numerous external agents. Quick and safe assembly. The black cable tie offers excellent resistance to UV rays thanks to added “carbon black.”



Advantages at a glance

- Made of Polyamide 6.6 for optimum resistance to extreme temperatures, bases, oils, greases, etc.
- Bent rounded tip allows easier insertion through the head of the cable ties
- Low-friction material coefficient allows a faster installation

Applications

- Electrical installations
- Industrial cabling
- Automotive cabling
- Marine cabling
- Panel building
- Special applications

Materials

Material Polyamide 6.6

Characteristics of raw material polyamide PA 6.6

Working temperature: -45°C to 85°C
 Tightening temperature: -10°C to 60°C
 Max admissible point: 120°C*
 Melting temperature: 256°C
 Limiting Oxygen Index (LOI): 27%
 Recovery of moisture: 2.7% to 50% relative humidity
 Halogen free: Evaluated according to EN 50146. Flame retardancy according to UL 94-V2

*(for a short time)

Resistance to external agents

Excellent resistance to aromatic solvents, bases, oils, fat, petroleum products
 Maintain limited contact with acid
 Not resistant to phenol and chlorinated solvents
 Resistance to UV (black colored cable ties)*

*The black cable ties are loaded with carbon black. Therefore they possess UV resistance according to standard ISO QUV-B 4892 (150 hours), equivalent to 3 years of exposure to sunlight. They are also particularly recommended for external applications.

Information

EC directives

The material used to produce our cable ties complies with the following EC directives:
 2000/53/EC (VHU)
 2002/95/EC (RoHS)
 2002/96/EC (DEEE)
 2003/11/EC

Technical data & Ordering information

Width	Designation	Length in mm	Maximum diameter in mm	Resistance to traction in Kgs	White Product No.	Black Product No.	Red Product No.	Yellow Product No.	Green Product No.	Blue Product No.
2.5	CABLE TIE 2.5 x 98	98	21	8	0860 0110 201	0860 0210 201	0860 0310 201	0860 0320 201	0860 0330 201	0860 0340 201
2.6	CABLE TIE 2.6 x 160	160	40	8	0860 0110 302	0860 0210 302				
3.5	CABLE TIE 3.5 x 140	140	35	13	0860 0110 401	0860 0210 401	0860 0310 401	0860 0320 401	0860 0330 401	0860 0340 401
	CABLE TIE 3.5 x 200	200	50	13	0860 0110 402	0860 0210 402	0860 0310 402	0860 0320 402	0860 0330 402	0860 0340 402
	CABLE TIE 3.5 x 290	290	80	13	0860 0110 403	0860 0210 403				
	CABLE TIE 3.5 x 370	370	103	13	0860 0110 404	0860 0210 404				
4.5	CABLE TIE 4.5 x 120	120	24	20	0860 0110 501	0860 0210 501				
	CABLE TIE 4.5 x 160	160	40	20	0860 0110 502	0860 0210 502				
	CABLE TIE 4.5 x 200	200	50	22	0860 0110 602	0860 0210 602	0860 0310 601	0860 0320 601	0860 0330 601	0860 0340 601
4.8	CABLE TIE 4.8 x 178	178	45	22	0860 0110 601	0860 0210 601				
	CABLE TIE 4.8 x 250	250	68	22	0860 0110 603	0860 0210 603				
4.5	CABLE TIE 4.5 x 290	290	79	22	0860 0110 604	0860 0210 604	0860 0310 602	0860 0320 602	0860 0330 602	0860 0340 602
	CABLE TIE 4.5 x 360	360	103	22	0860 0110 605	0860 0210 605				
4.8	CABLE TIE 4.8 x 390	390	106	22	0860 0110 606	0860 0210 606				
4.5	CABLE TIE 4.5 x 430	430	115	22	0860 0110 607	0860 0210 607				
7.8	CABLE TIE 7.8 x 180	180	45	55	0860 0110 702	0860 0210 702				
	CABLE TIE 7.8 x 240	240	63	55	0860 0110 703	0860 0210 703				
	CABLE TIE 7.8 x 300	300	80	55	0860 0110 704	0860 0210 704				
7.5	CABLE TIE 7.5 x 365	365	100	55	0860 0110 705	0860 0210 705				
	CABLE TIE 7.5 x 450	450	130	55	0860 0110 706	0860 0210 706				
	CABLE TIE 7.5 x 540	540	158	55	0860 0110 707	0860 0210 707				
	CABLE TIE 7.5 x 750	750	200	55	0860 0110 708	0860 0210 708				
9	CABLE TIE 9 x 780	780	233	77	0860 0110 801	0860 0210 801				
12.5	CABLE TIE 12.5 x 500	500	143	110	0860 0110 902	0860 0210 902				
	CABLE TIE 12.5 x 1000	1000	302	110	0860 0110 905	0860 0210 905				



Refer to pages 189 and 193.



- 1 Wave shaped perforated band
- 2 Straight shaped perforated band
- 3 Perforated band, multi holes
- 4 Perforated band, oval holes

Flexible fixing system for multiple applications

NORMAFIX® Perforated bands are suitable as suspension bands for various kinds of pipes. They can be used in a wide range of environments and applications.



Advantages at a glance

- Delivered in a plastic dispenser for easy handling
- Length: 10 m
- Possibility of performing several fixations by choosing the ideal diameter needed
- Easy to cut and fast to use

Applications

- Mounting cables, hoses and pipes

Materials

W1	W2	W3	W4	W5
x		x		x

Wave shape



NORMAFIX® PERFORATED BAND WAVE SHAPE					
Width x Thickness in mm	Designation	Length in m	W1 Product No.	W3 Product No.	W5 Product No.
17 x 0.8	PERFORATED BAND WAVE SHAPE 17 x 0.8/10	10	0863 0211 708	0863 0231 706	0863 0251 708

Straight shape



NORMAFIX® PERFORATED BAND STRAIGHT SHAPE			
Width x Thickness in mm	Designation	Length in m	W1 Product No.
12 x 0.8	PERFORATED BAND STRAIGHT SHAPE 12 x 0.8/10	10	0863 0311 208
17 x 0.8	PERFORATED BAND STRAIGHT SHAPE 17 x 0.8/10	10	0863 0311 708

Multi holes



NORMAFIX® PERFORATED BAND MULTI HOLES			
Width x Thickness in mm	Designation	Length in m	W1 Product No.
17 x 0.6	PERFORATED BAND ROUND HOLES 17 x 0.6	10	0890 1202 067
25 x 0.75	PERFORATED BAND ROUND HOLES 25 x 0.75	10	0890 1202 068

Oval holes



NORMAFIX® PERFORATED BAND OVAL HOLES			
Width x Thickness in mm	Designation	Length in m	W1 Product No.
17 x 0.6	PERFORATED BAND OVAL HOLES 17 x 0.6	10	0890 1202 065
25 x 0.75	PERFORATED BAND OVAL HOLES 25 x 0.75	10	0890 1202 066



Continuous band available in smooth version or with thread stamping throughout

4 different closure types to suit a huge variety of applications



Continuous band clamping system

Consisting of a continuous band, the NORMAFIX® NORMETTA® system is able to adapt itself to the shape and size of various objects. 4 different types of closure are available to choose from. The system is particularly suitable for carrying out retaining and repair work under difficult and extreme conditions.

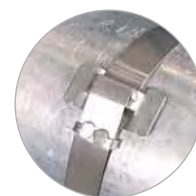

Advantages at a glance

- Flexible and versatile
- Can be installed under difficult conditions

Applications

- Irrigation systems
- Railway industry
- Building machines
- Pump and filter
- Retaining applications; sealing pipes during repair work
- Attaching signs and containers
- Binding hoses

Materials

W1	W2	W3	W4	W5
x	x	x	x	

Product and closure types

The continuous band is available in a 30 m roll and as either a smooth version with a range of band widths or a version with thread stamping throughout (with 12 mm band width only). It can also be supplied in different material grades.

Smooth band

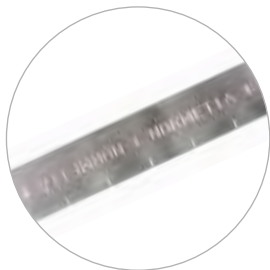

To be used with the buckles NB-A W1, NB-D W4 and NB-H W4.

NORMAFIX® NORMETTA SMOOTH BAND						
Width	Thickness	Designation	Length in m	Resistance to traction in N	W1 Product No.	W4 Product No.
5	0.35	NORMETTA SMOOTH BAND 30M/5 W1	30	350 N	0560 8500 004	
9	0.44	NORMETTA SMOOTH BAND 30M/9 W1	30	720 N	0560 8500 001	
	0.55	NORMETTA SMOOTH BAND 30M/9 W4	30	4100 N		0560 8554 009
13	0.7	NORMETTA SMOOTH BAND 30M/13 W4	30	7100 N		0560 8553 013
16	0.7	NORMETTA SMOOTH BAND 30M/16 W4	30	8800 N		0560 8553 016
19	0.7	NORMETTA SMOOTH BAND 30M/19 W4	30	10600 N		0560 8553 019



Refer to pages 180 and 189.

Stamped band



To be used with the buckles NB-G W1 and W3

NORMAFIX® NORMETTA STAMPED BAND						
Width	Thickness	Designation	Length in m	Resistance to traction in N	W1 Product No.	W3 Product No.
12	0.8	NORMETTA STAMPED BAND 30M/12 W1	30	1700 N	0560 8566 001	
	0.8	NORMETTA STAMPED BAND 30M/12 W3	30	2600 N		0560 8566 003



Refer to page 189.

Perforated Band



To be used with buckles NB-K W2.

NORMAFIX® NORMETTA PERFORATED BAND						
Width	Thickness	Designation	Length in m	Resistance to traction in N	W2 Product No.	W4 Product No.
8	0.6	NORMETTA PERFORATED BAND 25M/8 W2	25	790 N	0817 7020 001	
	0.6	NORMETTA PERFORATED BAND 25M/8 W4	25	790 N		0817 7022 001
13	0.6	NORMETTA PERFORATED BAND 25M/13 W4	25	850 N		0817 7022 002
14	0.6	NORMETTA PERFORATED BAND 25M/14 W2	25	850 N	0817 7020 002	



Refer to page 189.

NB-A



Closure type NB-A

Suitable for less demanding applications such as attaching signs and sealing low-pressure hoses. Can be re-used.

For bands: 5, 9 mm

Required tools: Steel pin, angled screwdriver or pliers, plate shears

NORMAFIX® NB-A		
For Band width	Designation	W1 Product No.
5	NB-A5	0560 8520 002
9	NB-A9	0560 8520 000



Refer to page 189.

NB-D



Closure type NB-D

Suitable for attaching signs and containers to pipes and hoses as well as binding hoses.

For bands: 9, 13, 16, 19 mm

Required tools: Clamping and cutting tool; hammer

NORMAFIX® NB-D		
For Band width	Designation	W4 Product No.
9	NB-D/9	0560 8550 009
13	NB-D/13	0560 8550 013
16	NB-D/16	0560 8550 016
19	NB-D/19	0560 8550 019



Refer to page 189.

NB-G



Closure type NB-G

Suitable for applications with cramped installation conditions.

Can be re-used.

For stamped bands.

Required tools: Screwdriver or SW7 socket wrench and plate shears

NORMAFIX® NB-G			
For Band width	Designation	W1 Product No.	W3 Product No.
12	NB-G/12	0560 8565 001	
	NB-G/12		0560 8565 003



Refer to page 189.

NB-H



Closure type NB-H

An adjustable quick-release closure that enables fast and easy installation and removal. Can be re-used.

For bands: 16, 19 mm

Required tools: Screwdriver and plate shears

NORMAFIX® NB-H				
For Band width	Maximum diameter in mm	Designation	W1 Product No.	W4 Product No.
16 / 19	124	NB-H/124	0560 8558 124	0560 0004 124
	400	NB-H/400	0560 8558 400	0560 0004 400
	800	NB-H/800	0560 8558 800	0560 0004 800



Refer to page 189.

NB-K



Closure type NB-K

Suitable for fixing suspended ventilation tubes.

For bands: 8, 13, 14 mm

Required tools: Screwdriver

NORMAFIX® NB-K			
For Band width	Designation	W2 Product No.	W4 Product No.
8	NB-K/8	0817 7019 003	0817 7021 003
13	NB-K/13		0817 7021 004
14	NB-K/14	0817 7019 004	



Refer to page 189.



- 1 Form-fit, adjustable band**
- Reinforced band ends**
- 2** – strengthen the band; prevent retaining sections from tearing or becoming loose during exposure to extremely high mechanical loads
- Can be supplied with rubber profile as an option**
- 3** – improved form closure between clip and clamping fixture
– damping

Pipe retaining clips in accordance with DIN 3016

NORMAFIX® RS/RSGU pipe retaining clips are suitable for all kinds of fastening and retaining applications: pipes, cables, cable harnesses, cable protection pipes, hoses and other lines.



Advantages at a glance

- Easy installation and secure fastening
- Reinforced band ends for extremely high mechanical loads
- Rubber profile protects against vibrations and creeping water, is sound-absorbent and protects against contact corrosion
- No single parts for the customer

Applications

- Machine building
- White goods
- Chemical industry
- Irrigation systems
- Ship manufacturing
- Food and beverage industry
- Railway industry
- Agricultural machines
- Building machines
- Engine manufacturing
- Pump and filter
- Mining industry

Materials

W1	W2	W3	W4	W5
x		x*	x*	x

*W3 and W4 on request

Rubber profile

MATERIAL PROPERTIES OF EPDM RUBBER PROFILE		
Material properties		EPDM rubber profile
Tensile strength [N/mm ²]		Min. 8
Elongation at break [%]		350
Shore hardness A		70 ± 5
Temperature [°C]		-40 to +120
Resistance to:	Weather/Ozone	Very good
	Aging/UV	Very good
	Fuel storage	Not suitable
	Storage in oils and greases	Not suitable
	Alcohols	Good
	Acids	Good
	Alkalis	Good

Silicone rubber profile also available on request.

Bolts

The scope of delivery does not include bolts or nuts.

We recommend:

For NORMAFIX® RSGU with 12mm band width: M5 bolt

For NORMAFIX® RSGU with 15mm band width: M6 bolt

For NORMAFIX® RSGU with 20mm band width: M8 bolt

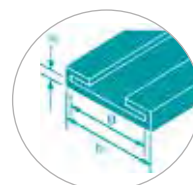

B = band width of clip
b₁ = width in mm
s₂ = material thickness in mm

Technical data & Ordering information

NORMAFIX® RSGU 1										
Band width	Designation	Clamping ranges		h1² ~	b1	s2	EPDM	Silicone	W1	W5
		in mm	in inches						Product No.	Product No.
12	RSGU1. 6/12	6	1/4	8.0+	15.0	1.2	x	x	0941 8912 006	0941 7712 006
	RSGU1. 8/12	8	5/16	8.0+	15.0	1.2	x	x	0941 8912 008	0941 7712 008
	RSGU1. 10/12	10	3/8	8.0+	15.0	1.2	x	x	0941 8912 010	0941 7712 010
	RSGU1. 12/12	12	1/2	8.0+	15.0	1.2	x	x	0941 8912 012	0941 7712 012
	RSGU1. 13/12	13	1/2	8.0+	15.0	1.2	x	x	0941 8912 013	0941 7712 013
	RSGU1. 14/12	14	9/16	8.0+	15.0	1.2	x	x	0941 8912 014	0941 7712 014
	RSGU1. 15/12	15	5/8	8.0+	15.0	1.2	x	x	0941 8912 015	0941 7712 015
	RSGU1. 16/12	16	5/8	8.0+	15.0	1.2	x	x	0941 8912 016	0941 7712 016
	RSGU1. 18/12	18	3/4	8.0+	15.0	1.2	x	x	0941 8912 018	0941 7712 018
	RSGU1. 19/12	19	3/4	8.0+	15.0	1.2	x	x	0941 8912 019	0941 7712 019
	RSGU1. 20/12	20	13/16	8.0+	15.0	1.2	x	x	0941 8912 020	0941 7712 020
	RSGU1. 21/12	21	13/16	8.0+	15.0	1.2	x	x	0941 8912 021	0941 7712 021
RSGU1. 22/12	22	7/8	8.0+	15.0	1.2	x	x	0941 8912 022	0941 7712 022	
15	RSGU1. 6/15	6	1/4	11.2+	18.5	1.5	x	x	0941 8915 006	0941 7715 006
	RSGU1. 8/15	8	5/16	11.2+	18.5	1.5	x	x	0941 8915 008	0941 7715 008
	RSGU1. 10/15	10	3/8	11.2+	18.5	1.5	x	x	0941 8915 010	0941 7715 010
	RSGU1. 12/15	12	1/2	11.2+	18.5	1.5	x	x	0941 8915 012	0941 7715 012
	RSGU1. 13/15	13	1/2	11.2+	18.5	1.5	x	x	0941 8915 013	0941 7715 013
	RSGU1. 14/15	14	9/16	11.2+	18.5	1.5	x	x	0941 8915 014	0941 7715 014
	RSGU1. 15/15	15	5/8	11.2+	18.5	1.5	x	x	0941 8915 015	0941 7715 015
	RSGU1. 16/15	16	5/8	11.2+	18.5	1.5	x	x	0941 8915 016	0941 7715 016
	RSGU1. 18/15	18	3/4	11.2+	18.5	1.5	x	x	0941 8915 018	0941 7715 018
	RSGU1. 19/15	19	3/4	11.2+	18.5	1.5	x	x	0941 8915 019	0941 7715 019
	RSGU1. 20/15	20	13/16	11.2+	18.5	1.5	x	x	0941 8915 020	0941 7715 020
	RSGU1. 21/15	21	13/16	11.2+	18.5	1.5	x	x	0941 8915 021	0941 7715 021
	RSGU1. 22/15	22	7/8	11.2+	18.5	1.5	x	x	0941 8915 022	0941 7715 022
	RSGU1. 23/15	23	7/8	11.2+	18.5	1.5	x	x	0941 8915 023	0941 7715 023
	RSGU1. 25/15	25	1	11.2+	18.5	1.5	x	x	0941 8915 025	0941 7715 025
	RSGU1. 26/15	26	11/16	11.2+	18.5	1.5	x	x	0941 8915 026	0941 7715 026
	RSGU1. 28/15	28	11/8	11.2+	18.5	1.5	x	x	0941 8915 028	0941 7715 028
	RSGU1. 30/15	30	13/16	11.2+	18.5	1.5	x	x	0941 8915 030	0941 7715 030
RSGU1. 32/15	32	11/4	11.2+	18.5	1.5	x	x	0941 8915 032	0941 7715 032	
RSGU1. 34/15	34	15/16	11.2+	18.5	1.5	x	x	0941 8915 034	0941 7715 034	
RSGU1. 35/15	35	13/8	11.2+	18.5	1.5	x	x	0941 8915 035	0941 7715 035	
20	RSGU1. 10/20	10	3/8	14.5+	25.0	2.0	x	x	0941 8920 010	0941 7720 010
	RSGU1. 12/20	12	1/2	14.5+	25.0	2.0	x	x	0941 8920 012	0941 7720 012
	RSGU1. 13/20	13	1/2	14.5+	25.0	2.0	x	x	0941 8920 013	0941 7720 013
	RSGU1. 14/20	14	9/16	14.5+	25.0	2.0	x	x	0941 8920 014	0941 7720 014
	RSGU1. 15/20	15	5/8	14.5+	25.0	2.0	x	x	0941 8920 015	0941 7720 015
	RSGU1. 16/20	16	5/8	14.5+	25.0	2.0	x	x	0941 8920 016	0941 7720 016
	RSGU1. 18/20	18	3/4	14.5+	25.0	2.0	x	x	0941 8920 018	0941 7720 018
	RSGU1. 19/20	19	3/4	14.5+	25.0	2.0	x	x	0941 8920 019	0941 7720 019
	RSGU1. 20/20	20	13/16	14.5+	25.0	2.0	x	x	0941 8920 020	0941 7720 020
	RSGU1. 22/20	22	7/8	14.5+	25.0	2.0	x	x	0941 8920 022	0941 7720 022
	RSGU1. 23/20	23	7/8	14.5+	25.0	2.0	x	x	0941 8920 023	0941 7720 023
	RSGU1. 24/20	24	15/16	14.5+	25.0	2.0	x	x	0941 8920 024	0941 7720 024
	RSGU1. 25/20	25	1	14.5+	25.0	2.0	x	x	0941 8920 025	0941 7720 025
	RSGU1. 28/20	28	11/8	14.5+	25.0	2.0	x	x	0941 8920 028	0941 7720 028
	RSGU1. 30/20	30	13/16	14.5+	25.0	2.0	x	x	0941 8920 030	0941 7720 030
	RSGU1. 32/20	32	11/4	14.5+	25.0	2.0	x	x	0941 8920 032	0941 7720 032
	RSGU1. 34/20	34	15/16	14.5+	25.0	2.0	x	x	0941 8920 034	0941 7720 034
	RSGU1. 35/20	35	13/8	14.5+	25.0	2.0	x	x	0941 8920 035	0941 7720 035
RSGU1. 36/20	36	17/16	14.5+	25.0	2.0	x	x	0941 8920 036	0941 7720 036	
RSGU1. 38/20	38	11/2	14.5+	25.0	2.0	x	x	0941 8920 038	0941 7720 038	
RSGU1. 40/20	40	19/16	14.5+	25.0	2.0	x	x	0941 8920 040	0941 7720 040	

Band width 9 mm and 25 mm on request
Additional diameters on request



Refer to page 182.

RSGU 0



NORMAFIX® RSGU 0										
Band width	Designation	Clamping ranges		h1 ² ~	b1	s2	EPDM	Silicone	W1	W5
		in mm	in inches						Product No.	Product No.
12	RSGU. 6/12	6	1/4	8.0+	15.0	1.2	x	x	0940 8912 006	0940 7712 006
	RSGU. 8/12	8	5/16	8.0+	15.0	1.2	x	x	0940 8912 008	0940 7712 008
	RSGU. 10/12	10	3/8	8.0+	15.0	1.2	x	x	0940 8912 010	0940 7712 010
	RSGU. 12/12	12	1/2	8.0+	15.0	1.2	x	x	0940 8912 012	0940 7712 012
	RSGU. 13/12	13	1/2	8.0+	15.0	1.2	x	x	0940 8912 013	0940 7712 013
	RSGU. 14/12	14	9/16	8.0+	15.0	1.2	x	x	0940 8912 014	0940 7712 014
	RSGU. 15/12	15	5/8	8.0+	15.0	1.2	x	x	0940 8912 015	0940 7712 015
	RSGU. 16/12	16	5/8	8.0+	15.0	1.2	x	x	0940 8912 016	0940 7712 016
	RSGU. 18/12	18	3/4	8.0+	15.0	1.2	x	x	0940 8912 018	0940 7712 018
	RSGU. 19/12	19	3/4	8.0+	15.0	1.2	x	x	0940 8912 019	0940 7712 019
	RSGU. 20/12	20	13/16	8.0+	15.0	1.2	x	x	0940 8912 020	0940 7712 020
	RSGU. 21/12	21	13/16	8.0+	15.0	1.2	x	x	0940 8912 021	0940 7712 021
RSGU. 22/12	22	7/8	8.0+	15.0	1.2	x	x	0940 8912 022	0940 7712 022	
15	RSGU. 6/15	6	1/4	11.2+	18.5	1.5	x	x	0940 8915 006	0940 7715 006
	RSGU. 8/15	8	5/16	11.2+	18.5	1.5	x	x	0940 8915 008	0940 7715 008
	RSGU. 10/15	10	3/8	11.2+	18.5	1.5	x	x	0940 8915 010	0940 7715 010
	RSGU. 12/15	12	1/2	11.2+	18.5	1.5	x	x	0940 8915 012	0940 7715 012
	RSGU. 13/15	13	1/2	11.2+	18.5	1.5	x	x	0940 8915 013	0940 7715 013
	RSGU. 14/15	14	9/16	11.2+	18.5	1.5	x	x	0940 8915 014	0940 7715 014
	RSGU. 15/15	15	5/8	11.2+	18.5	1.5	x	x	0940 8915 015	0940 7715 015
	RSGU. 16/15	16	5/8	11.2+	18.5	1.5	x	x	0940 8915 016	0940 7715 016
	RSGU. 18/15	18	3/4	11.2+	18.5	1.5	x	x	0940 8915 018	0940 7715 018
	RSGU. 19/15	19	3/4	11.2+	18.5	1.5	x	x	0940 8915 019	0940 7715 019
	RSGU. 20/15	20	13/16	11.2+	18.5	1.5	x	x	0940 8915 020	0940 7715 020
	RSGU. 21/15	21	13/16	11.2+	18.5	1.5	x	x	0940 8915 021	0940 7715 021
	RSGU. 22/15	22	7/8	11.2+	18.5	1.5	x	x	0940 8915 022	0940 7715 022
	RSGU. 23/15	23	7/8	11.2+	18.5	1.5	x	x	0940 8915 023	0940 7715 023
	RSGU. 25/15	25	1	11.2+	18.5	1.5	x	x	0940 8915 025	0940 7715 025
	RSGU. 26/15	26	11/16	11.2+	18.5	1.5	x	x	0940 8915 026	0940 7715 026
	RSGU. 28/15	28	11/8	11.2+	18.5	1.5	x	x	0940 8915 028	0940 7715 028
	RSGU. 30/15	30	13/16	11.2+	18.5	1.5	x	x	0940 8915 030	0940 7715 030
RSGU. 32/15	32	11/4	11.2+	18.5	1.5	x	x	0940 8915 032	0940 7715 032	
RSGU. 34/15	34	15/16	11.2+	18.5	1.5	x	x	0940 8915 034	0940 7715 034	
RSGU. 35/15	35	13/8	11.2+	18.5	1.5	x	x	0940 8915 035	0940 7715 035	
20	RSGU. 10/20	10	3/8	14.5+	25.0	2.0	x	x	0940 8920 010	0940 7720 010
	RSGU. 12/20	12	1/2	14.5+	25.0	2.0	x	x	0940 8920 012	0940 7720 012
	RSGU. 13/20	13	1/2	14.5+	25.0	2.0	x	x	0940 8920 013	0940 7720 013
	RSGU. 14/20	14	9/16	14.5+	25.0	2.0	x	x	0940 8920 014	0940 7720 014
	RSGU. 15/20	15	5/8	14.5+	25.0	2.0	x	x	0940 8920 015	0940 7720 015
	RSGU. 16/20	16	5/8	14.5+	25.0	2.0	x	x	0940 8920 016	0940 7720 016
	RSGU. 18/20	18	3/4	14.5+	25.0	2.0	x	x	0940 8920 018	0940 7720 018
	RSGU. 19/20	19	3/4	14.5+	25.0	2.0	x	x	0940 8920 019	0940 7720 019
	RSGU. 20/20	20	13/16	14.5+	25.0	2.0	x	x	0940 8920 020	0940 7720 020
	RSGU. 22/20	22	7/8	14.5+	25.0	2.0	x	x	0940 8920 022	0940 7720 022
	RSGU. 23/20	23	7/8	14.5+	25.0	2.0	x	x	0940 8920 023	0940 7720 023
	RSGU. 24/20	24	15/16	14.5+	25.0	2.0	x	x	0940 8920 024	0940 7720 024
	RSGU. 25/20	25	1	14.5+	25.0	2.0	x	x	0940 8920 025	0940 7720 025
	RSGU. 28/20	28	11/8	14.5+	25.0	2.0	x	x	0940 8920 028	0940 7720 028
	RSGU. 30/20	30	13/16	14.5+	25.0	2.0	x	x	0940 8920 030	0940 7720 030
	RSGU. 32/20	32	11/4	14.5+	25.0	2.0	x	x	0940 8920 032	0940 7720 032
	RSGU. 34/20	34	15/16	14.5+	25.0	2.0	x	x	0940 8920 034	0940 7720 034
	RSGU. 35/20	35	13/8	14.5+	25.0	2.0	x	x	0940 8920 035	0940 7720 035
RSGU. 36/20	36	17/16	14.5+	25.0	2.0	x	x	0940 8920 036	0940 7720 036	
RSGU. 38/20	38	11/2	14.5+	25.0	2.0	x	x	0940 8920 038	0940 7720 038	
RSGU. 40/20	40	19/16	14.5+	25.0	2.0	x	x	0940 8920 040	0940 7720 040	

Band width 9 mm and 25 mm on request
Additional diameters on request

RSGU 2



NORMAFIX® RSGU 2										
Band width	Designation	Clamping ranges		h1 ² ~	b1	s2	EPDM	Silicone	W1	W5
		in mm	in inches						Product No.	Product No.
12	RSGU2. 6/12	6	1/4	8.0+	15.0	1.2	x	x	0942 8912 006	0942 7712 006
	RSGU2. 8/12	8	5/16	8.0+	15.0	1.2	x	x	0942 8912 008	0942 7712 008
	RSGU2. 10/12	10	3/8	8.0+	15.0	1.2	x	x	0942 8912 010	0942 7712 010
	RSGU2. 12/12	12	1/2	8.0+	15.0	1.2	x	x	0942 8912 012	0942 7712 012
	RSGU2. 13/12	13	1/2	8.0+	15.0	1.2	x	x	0942 8912 013	0942 7712 013
	RSGU2. 14/12	14	9/16	8.0+	15.0	1.2	x	x	0942 8912 014	0942 7712 014
	RSGU2. 15/12	15	5/8	8.0+	15.0	1.2	x	x	0942 8912 015	0942 7712 015
	RSGU2. 16/12	16	5/8	8.0+	15.0	1.2	x	x	0942 8912 016	0942 7712 016
	RSGU2. 18/12	18	3/4	8.0+	15.0	1.2	x	x	0942 8912 018	0942 7712 018
	RSGU2. 19/12	19	3/4	8.0+	15.0	1.2	x	x	0942 8912 019	0942 7712 019
	RSGU2. 20/12	20	13/16	8.0+	15.0	1.2	x	x	0942 8912 020	0942 7712 020
	RSGU2. 21/12	21	13/16	8.0+	15.0	1.2	x	x	0942 8912 021	0942 7712 021
RSGU2. 22/12	22	7/8	8.0+	15.0	1.2	x	x	0942 8912 022	0942 7712 022	
15	RSGU2. 6/15	6	1/4	11.2+	18.5	1.5	x	x	0942 8915 006	0942 7715 006
	RSGU2. 8/15	8	5/16	11.2+	18.5	1.5	x	x	0942 8915 008	0942 7715 008
	RSGU2. 10/15	10	3/8	11.2+	18.5	1.5	x	x	0942 8915 010	0942 7715 010
	RSGU2. 12/15	12	1/2	11.2+	18.5	1.5	x	x	0942 8915 012	0942 7715 012
	RSGU2. 13/15	13	1/2	11.2+	18.5	1.5	x	x	0942 8915 013	0942 7715 013
	RSGU2. 14/15	14	9/16	11.2+	18.5	1.5	x	x	0942 8915 014	0942 7715 014
	RSGU2. 15/15	15	5/8	11.2+	18.5	1.5	x	x	0942 8915 015	0942 7715 015
	RSGU2. 16/15	16	5/8	11.2+	18.5	1.5	x	x	0942 8915 016	0942 7715 016
	RSGU2. 18/15	18	3/4	11.2+	18.5	1.5	x	x	0942 8915 018	0942 7715 018
	RSGU2. 19/15	19	3/4	11.2+	18.5	1.5	x	x	0942 8915 019	0942 7715 019
	RSGU2. 20/15	20	13/16	11.2+	18.5	1.5	x	x	0942 8915 020	0942 7715 020
	RSGU2. 21/15	21	13/16	11.2+	18.5	1.5	x	x	0942 8915 021	0942 7715 021
	RSGU2. 22/15	22	7/8	11.2+	18.5	1.5	x	x	0942 8915 022	0942 7715 022
	RSGU2. 23/15	23	7/8	11.2+	18.5	1.5	x	x	0942 8915 023	0942 7715 023
	RSGU2. 25/15	25	1	11.2+	18.5	1.5	x	x	0942 8915 025	0942 7715 025
	RSGU2. 26/15	26	11/16	11.2+	18.5	1.5	x	x	0942 8915 026	0942 7715 026
	RSGU2. 28/15	28	11/8	11.2+	18.5	1.5	x	x	0942 8915 028	0942 7715 028
	RSGU2. 30/15	30	13/16	11.2+	18.5	1.5	x	x	0942 8915 030	0942 7715 030
RSGU2. 32/15	32	11/4	11.2+	18.5	1.5	x	x	0942 8915 032	0942 7715 032	
RSGU2. 34/15	34	15/16	11.2+	18.5	1.5	x	x	0942 8915 034	0942 7715 034	
RSGU2. 35/15	35	13/8	11.2+	18.5	1.5	x	x	0942 8915 035	0942 7715 035	
20	RSGU2. 10/20	10	3/8	14.5+	25.0	2.0	x	x	0942 8920 010	0942 7720 010
	RSGU2. 12/20	12	1/2	14.5+	25.0	2.0	x	x	0942 8920 012	0942 7720 012
	RSGU2. 13/20	13	1/2	14.5+	25.0	2.0	x	x	0942 8920 013	0942 7720 013
	RSGU2. 14/20	14	9/16	14.5+	25.0	2.0	x	x	0942 8920 014	0942 7720 014
	RSGU2. 15/20	15	5/8	14.5+	25.0	2.0	x	x	0942 8920 015	0942 7720 015
	RSGU2. 16/20	16	5/8	14.5+	25.0	2.0	x	x	0942 8920 016	0942 7720 016
	RSGU2. 18/20	18	3/4	14.5+	25.0	2.0	x	x	0942 8920 018	0942 7720 018
	RSGU2. 19/20	19	3/4	14.5+	25.0	2.0	x	x	0942 8920 019	0942 7720 019
	RSGU2. 20/20	20	13/16	14.5+	25.0	2.0	x	x	0942 8920 020	0942 7720 020
	RSGU2. 22/20	22	7/8	14.5+	25.0	2.0	x	x	0942 8920 022	0942 7720 022
	RSGU2. 23/20	23	7/8	14.5+	25.0	2.0	x	x	0942 8920 023	0942 7720 023
	RSGU2. 24/20	24	15/16	14.5+	25.0	2.0	x	x	0942 8920 024	0942 7720 024
	RSGU2. 25/20	25	1	14.5+	25.0	2.0	x	x	0942 8920 025	0942 7720 025
	RSGU2. 28/20	28	11/8	14.5+	25.0	2.0	x	x	0942 8920 028	0942 7720 028
	RSGU2. 30/20	30	13/16	14.5+	25.0	2.0	x	x	0942 8920 030	0942 7720 030
	RSGU2. 32/20	32	11/4	14.5+	25.0	2.0	x	x	0942 8920 032	0942 7720 032
	RSGU2. 34/20	34	15/16	14.5+	25.0	2.0	x	x	0942 8920 034	0942 7720 034
	RSGU2. 35/20	35	13/8	14.5+	25.0	2.0	x	x	0942 8920 035	0942 7720 035
RSGU2. 36/20	36	17/16	14.5+	25.0	2.0	x	x	0942 8920 036	0942 7720 036	
RSGU2. 38/20	38	11/2	14.5+	25.0	2.0	x	x	0942 8920 038	0942 7720 038	
RSGU2. 40/20	40	19/16	14.5+	25.0	2.0	x	x	0942 8920 040	0942 7720 040	

Band width 9 mm and 25 mm on request
Additional diameters on request

RS 0



NORMAFIX® RS 0									
Band width	Designation	Clamping ranges		d	h1 ² ~	l	s	W1 Product No.	W5 Product No.
		in mm	in inches						
12	RS 0. 6/12	6	1/4	5.3 (M5)	6.8+	5.0	0.5	0410 8912 006	0410 7712 006
	RS 0. 8/12	8	5/16	5.3 (M5)	6.8+	5.0	0.5	0410 8912 008	0410 7712 008
	RS 0. 10/12	10	3/8	5.3 (M5)	6.8+	5.0	0.5	0410 8912 010	0410 7712 010
	RS 0. 12/12	12	1/2	5.3 (M5)	6.8+	5.0	0.5	0410 8912 012	0410 7712 012
	RS 0. 13/12	13	1/2	5.3 (M5)	6.8+	5.0	0.5	0410 8912 013	0410 7712 013
	RS 0. 14/12	14	9/16	5.3 (M5)	6.8+	5.0	0.5	0410 8912 014	0410 7712 014
	RS 0. 15/12	15	5/8	5.3 (M5)	6.8+	5.0	0.5	0410 8912 015	0410 7712 015
	RS 0. 16/12	16	5/8	5.3 (M5)	6.8+	5.0	0.5	0410 8912 016	0410 7712 016
	RS 0. 18/12	18	3/4	5.3 (M5)	6.8+	5.0	0.5	0410 8912 018	0410 7712 018
	RS 0. 19/12	19	3/4	5.3 (M5)	6.8+	5.0	0.5	0410 8912 019	0410 7712 019
	RS 0. 20/12	20	13/16	5.3 (M5)	6.8+	5.0	0.5	0410 8912 020	0410 7712 020
	RS 0. 21/12	21	13/16	5.3 (M5)	6.8+	5.0	0.5	0410 8912 021	0410 7712 021
RS 0. 22/12	22	7/8	5.3 (M5)	6.8+	5.0	0.5	0410 8912 022	0410 7712 022	
15	RS 0. 6/15	6	1/4	6.4 (M6)	9.7+	6.0	0.6	0410 8915 006	0410 7715 006
	RS 0. 8/15	8	5/16	6.4 (M6)	9.7+	6.0	0.6	0410 8915 008	0410 7715 008
	RS 0. 10/15	10	3/8	6.4 (M6)	9.7+	6.0	0.6	0410 8915 010	0410 7715 010
	RS 0. 12/15	12	1/2	6.4 (M6)	9.7+	6.0	0.6	0410 8915 012	0410 7715 012
	RS 0. 13/15	13	1/2	6.4 (M6)	9.7+	6.0	0.6	0410 8915 013	0410 7715 013
	RS 0. 14/15	14	9/16	6.4 (M6)	9.7+	6.0	0.6	0410 8915 014	0410 7715 014
	RS 0. 15/15	15	5/8	6.4 (M6)	9.7+	6.0	0.8	0410 8915 015	0410 7715 015
	RS 0. 16/15	16	5/8	6.4 (M6)	9.7+	6.0	0.8	0410 8915 016	0410 7715 016
	RS 0. 18/15	18	3/4	6.4 (M6)	9.7+	6.0	0.8	0410 8915 018	0410 7715 018
	RS 0. 19/15	19	3/4	6.4 (M6)	9.7+	6.0	0.8	0410 8915 019	0410 7715 019
	RS 0. 20/15	20	13/16	6.4 (M6)	9.7+	6.0	0.8	0410 8915 020	0410 7715 020
	RS 0. 21/15	21	13/16	6.4 (M6)	9.7+	6.0	0.8	0410 8915 021	0410 7715 021
	RS 0. 22/15	22	7/8	6.4 (M6)	9.7+	6.0	0.8	0410 8915 022	0410 7715 022
	RS 0. 23/15	23	7/8	6.4 (M6)	9.7+	6.0	0.8	0410 8915 023	0410 7715 023
	RS 0. 25/15	25	1	6.4 (M6)	9.7+	6.0	0.8	0410 8915 025	0410 7715 025
	RS 0. 26/15	26	11/16	6.4 (M6)	9.7+	6.0	0.8	0410 8915 026	0410 7715 026
	RS 0. 28/15	28	11/8	6.4 (M6)	9.7+	6.0	0.8	0410 8915 028	0410 7715 028
	RS 0. 30/15	30	13/16	6.4 (M6)	9.7+	6.0	0.8	0410 8915 030	0410 7715 030
RS 0. 32/15	32	11/4	6.4 (M6)	9.7+	6.0	0.8	0410 8915 032	0410 7715 032	
RS 0. 34/15	34	15/16	6.4 (M6)	9.7+	6.0	0.8	0410 8915 034	0410 7715 034	
RS 0. 35/15	35	13/8	6.4 (M6)	9.7+	6.0	0.8	0410 8915 035	0410 7715 035	
20	RS 0. 10/20	10	3/8	8.4 (M8)	12.5+	8.5	0.8	0410 8920 010	0410 7720 010
	RS 0. 12/20	12	1/2	8.4 (M8)	12.5+	8.5	0.8	0410 8920 012	0410 7720 012
	RS 0. 13/20	13	1/2	8.4 (M8)	12.5+	8.5	0.8	0410 8920 013	0410 7720 013
	RS 0. 14/20	14	9/16	8.4 (M8)	12.5+	8.5	0.8	0410 8920 014	0410 7720 014
	RS 0. 15/20	15	5/8	8.4 (M8)	12.5+	8.5	0.8	0410 8920 015	0410 7720 015
	RS 0. 16/20	16	5/8	8.4 (M8)	12.5+	8.5	0.8	0410 8920 016	0410 7720 016
	RS 0. 18/20	18	3/4	8.4 (M8)	12.5+	8.5	0.8	0410 8920 018	0410 7720 018
	RS 0. 19/20	19	3/4	8.4 (M8)	12.5+	8.5	0.8	0410 8920 019	0410 7720 019
	RS 0. 20/20	20	13/16	8.4 (M8)	12.5+	8.5	0.8	0410 8920 020	0410 7720 020
	RS 0. 22/20	22	7/8	8.4 (M8)	12.5+	8.5	0.8	0410 8920 022	0410 7720 022
	RS 0. 23/20	23	7/8	8.4 (M8)	12.5+	8.5	0.8	0410 8920 023	0410 7720 023
	RS 0. 24/20	24	15/16	8.4 (M8)	12.5+	8.5	0.8	0410 8920 024	0410 7720 024
	RS 0. 25/20	25	1	8.4 (M8)	12.5+	8.5	0.8	0410 8920 025	0410 7720 025
	RS 0. 28/20	28	11/8	8.4 (M8)	12.5+	8.5	1.0	0410 8920 028	0410 7720 028
	RS 0. 30/20	30	13/16	8.4 (M8)	12.5+	8.5	1.0	0410 8920 030	0410 7720 030
	RS 0. 32/20	32	11/4	8.4 (M8)	12.5+	8.5	1.0	0410 8920 032	0410 7720 032
	RS 0. 34/20	34	15/16	8.4 (M8)	12.5+	8.5	1.0	0410 8920 034	0410 7720 034
	RS 0. 35/20	35	13/8	8.4 (M8)	12.5+	8.5	1.0	0410 8920 035	0410 7720 035
RS 0. 36/20	36	17/16	8.4 (M8)	12.5+	8.5	1.0	0410 8920 036	0410 7720 036	
RS 0. 38/20	38	11/2	8.4 (M8)	12.5+	8.5	1.0	0410 8920 038	0410 7720 038	
RS 0. 40/20	40	19/16	8.4 (M8)	12.5+	8.5	1.0	0410 8920 040	0410 7720 040	

Band width 9 mm and 25 mm on request
Additional diameters on request

RS 1



NORMAFIX® RS 1									
Band width	Designation	Clamping ranges		d	h1 ² ~	l	s	W1	W5
		in mm	in inches					Product No.	Product No.
12	RS 1. 6/12	6	1/4	5.3 (M5)	6.8+	5.0	0.5	0411 8912 006	0411 7712 006
	RS 1. 8/12	8	5/16	5.3 (M5)	6.8+	5.0	0.5	0411 8912 008	0411 7712 008
	RS 1. 10/12	10	3/8	5.3 (M5)	6.8+	5.0	0.5	0411 8912 010	0411 7712 010
	RS 1. 12/12	12	1/2	5.3 (M5)	6.8+	5.0	0.5	0411 8912 012	0411 7712 012
	RS 1. 13/12	13	1/2	5.3 (M5)	6.8+	5.0	0.5	0411 8912 013	0411 7712 013
	RS 1. 14/12	14	9/16	5.3 (M5)	6.8+	5.0	0.5	0411 8912 014	0411 7712 014
	RS 1. 15/12	15	5/8	5.3 (M5)	6.8+	5.0	0.5	0411 8912 015	0411 7712 015
	RS 1. 16/12	16	5/8	5.3 (M5)	6.8+	5.0	0.5	0411 8912 016	0411 7712 016
	RS 1. 18/12	18	3/4	5.3 (M5)	6.8+	5.0	0.5	0411 8912 018	0411 7712 018
	RS 1. 19/12	19	3/4	5.3 (M5)	6.8+	5.0	0.5	0411 8912 019	0411 7712 019
	RS 1. 20/12	20	13/16	5.3 (M5)	6.8+	5.0	0.5	0411 8912 020	0411 7712 020
	RS 1. 21/12	21	13/16	5.3 (M5)	6.8+	5.0	0.5	0411 8912 021	0411 7712 021
RS 1. 22/12	22	7/8	5.3 (M5)	6.8+	5.0	0.5	0411 8912 022	0411 7712 022	
15	RS 1. 6/15	6	1/4	6.4 (M6)	9.7+	6.0	0.6	0411 8915 006	0411 7715 006
	RS 1. 8/15	8	5/16	6.4 (M6)	9.7+	6.0	0.6	0411 8915 008	0411 7715 008
	RS 1. 10/15	10	3/8	6.4 (M6)	9.7+	6.0	0.6	0411 8915 010	0411 7715 010
	RS 1. 12/15	12	1/2	6.4 (M6)	9.7+	6.0	0.6	0411 8915 012	0411 7715 012
	RS 1. 13/15	13	1/2	6.4 (M6)	9.7+	6.0	0.6	0411 8915 013	0411 7715 013
	RS 1. 14/15	14	9/16	6.4 (M6)	9.7+	6.0	0.8	0411 8915 014	0411 7715 014
	RS 1. 15/15	15	5/8	6.4 (M6)	9.7+	6.0	0.8	0411 8915 015	0411 7715 015
	RS 1. 16/15	16	5/8	6.4 (M6)	9.7+	6.0	0.8	0411 8915 016	0411 7715 016
	RS 1. 18/15	18	3/4	6.4 (M6)	9.7+	6.0	0.8	0411 8915 018	0411 7715 018
	RS 1. 19/15	19	3/4	6.4 (M6)	9.7+	6.0	0.8	0411 8915 019	0411 7715 019
	RS 1. 20/15	20	13/16	6.4 (M6)	9.7+	6.0	0.8	0411 8915 020	0411 7715 020
	RS 1. 21/15	21	13/16	6.4 (M6)	9.7+	6.0	0.8	0411 8915 021	0411 7715 021
	RS 1. 22/15	22	7/8	6.4 (M6)	9.7+	6.0	0.8	0411 8915 022	0411 7715 022
	RS 1. 23/15	23	7/8	6.4 (M6)	9.7+	6.0	0.8	0411 8915 023	0411 7715 023
	RS 1. 25/15	25	1	6.4 (M6)	9.7+	6.0	0.8	0411 8915 025	0411 7715 025
	RS 1. 26/15	26	11/16	6.4 (M6)	9.7+	6.0	0.8	0411 8915 026	0411 7715 026
	RS 1. 28/15	28	11/8	6.4 (M6)	9.7+	6.0	0.8	0411 8915 028	0411 7715 028
	RS 1. 30/15	30	13/16	6.4 (M6)	9.7+	6.0	0.8	0411 8915 030	0411 7715 030
RS 1. 32/15	32	11/4	6.4 (M6)	9.7+	6.0	0.8	0411 8915 032	0411 7715 032	
RS 1. 34/15	34	15/16	6.4 (M6)	9.7+	6.0	0.8	0411 8915 034	0411 7715 034	
RS 1. 35/15	35	13/8	6.4 (M6)	9.7+	6.0	0.8	0411 8915 035	0411 7715 035	
20	RS 1. 10/20	10	3/8	8.4 (M8)	12.5+	8.5	0.8	0411 8920 009	0411 7720 010
	RS 1. 12/20	12	1/2	8.4 (M8)	12.5+	8.5	0.8	0411 8920 011	0411 7720 012
	RS 1. 13/20	13	1/2	8.4 (M8)	12.5+	8.5	0.8	0411 8920 012	0411 7720 013
	RS 1. 14/20	14	9/16	8.4 (M8)	12.5+	8.5	0.8	0411 8920 013	0411 7720 014
	RS 1. 15/20	15	5/8	8.4 (M8)	12.5+	8.5	0.8	0411 8920 014	0411 7720 015
	RS 1. 16/20	16	5/8	8.4 (M8)	12.5+	8.5	0.8	0411 8920 015	0411 7720 016
	RS 1. 18/20	18	3/4	8.4 (M8)	12.5+	8.5	0.8	0411 8920 017	0411 7720 018
	RS 1. 19/20	19	3/4	8.4 (M8)	12.5+	8.5	0.8	0411 8920 018	0411 7720 019
	RS 1. 20/20	20	13/16	8.4 (M8)	12.5+	8.5	0.8	0411 8920 019	0411 7720 020
	RS 1. 22/20	22	7/8	8.4 (M8)	12.5+	8.5	0.8	0411 8920 021	0411 7720 022
	RS 1. 23/20	23	7/8	8.4 (M8)	12.5+	8.5	0.8	0411 8920 022	0411 7720 023
	RS 1. 24/20	24	15/16	8.4 (M8)	12.5+	8.5	0.8	0411 8920 023	0411 7720 024
	RS 1. 25/20	25	1	8.4 (M8)	12.5+	8.5	0.8	0411 8920 024	0411 7720 025
	RS 1. 28/20	28	11/8	8.4 (M8)	12.5+	8.5	0.8	0411 8920 027	0411 7720 028
	RS 1. 30/20	30	13/16	8.4 (M8)	12.5+	8.5	1.0	0411 8920 029	0411 7720 030
	RS 1. 32/20	32	11/4	8.4 (M8)	12.5+	8.5	1.0	0411 8920 032	0411 7720 032
	RS 1. 34/20	34	15/16	8.4 (M8)	12.5+	8.5	1.0	0411 8920 034	0411 7720 034
	RS 1. 35/20	35	13/8	8.4 (M8)	12.5+	8.5	1.0	0411 8920 035	0411 7720 035
RS 1. 36/20	36	17/16	8.4 (M8)	12.5+	8.5	1.0	0411 8920 036	0411 7720 036	
RS 1. 38/20	38	11/2	8.4 (M8)	12.5+	8.5	1.0	0411 8920 038	0411 7720 038	
RS 1. 40/20	40	19/16	8.4 (M8)	12.5+	8.5	1.0	0411 8920 040	0411 7720 040	

Band width 9 mm and 25 mm on request
Additional diameters on request

RS 2



NORMAFIX® RS 2									
Band width	Designation	Clamping ranges		d	h1 ² ~	l	s	W1 Product No.	W5 Product No.
		in mm	in inches						
12	RS 2. 6/12	6	1/4	4.3 (M4)	4.7+	3.8	0.4	0412 8912 006	0412 7712 006
	RS 2. 8/12	8	5/16	4.3 (M4)	4.7+	3.8	0.4	0412 8912 008	0412 7712 008
	RS 2. 10/12	10	3/8	5.3 (M5)	6.8+	5.0	0.5	0412 8912 010	0412 7712 010
	RS 2. 12/12	12	1/2	5.3 (M5)	6.8+	5.0	0.5	0412 8912 012	0412 7712 012
	RS 2. 13/12	13	1/2	4.3 (M4)	4.7+	3.8	0.4	0412 8912 013	0412 7712 013
	RS 2. 14/12	14	9/16	4.3 (M4)	4.7+	3.8	0.4	0412 8912 014	0412 7712 014
	RS 2. 15/12	15	5/8	4.3 (M4)	4.7+	3.8	0.4	0412 8912 015	0412 7712 015
	RS 2. 16/12	16	5/8	5.3 (M5)	6.8+	5.0	0.5	0412 8912 016	0412 7712 016
	RS 2. 18/12	18	3/4	5.3 (M5)	6.8+	5.0	0.5	0412 8912 018	0412 7712 018
	RS 2. 19/12	19	3/4	4.3 (M4)	4.7+	3.8	0.4	0412 8912 019	0412 7712 019
	RS 2. 20/12	20	13/16	4.3 (M4)	4.7+	3.8	0.4	0412 8912 020	0412 7712 020
	RS 2. 21/12	21	13/16	4.3 (M4)	4.7+	3.8	0.4	0412 8912 021	0412 7712 021
RS 2. 22/12	22	7/8	5.3 (M5)	6.8+	5.0	0.5	0412 8912 022	0412 7712 022	
15	RS 2. 6/15	6	1/4	6.4 (M6)	9.7+	6.0	0.6	0412 8915 006	0412 7715 006
	RS 2. 8/15	8	5/16	6.4 (M6)	9.7+	6.0	0.6	0412 8915 008	0412 7715 008
	RS 2. 10/15	10	3/8	6.4 (M6)	9.7+	6.0	0.6	0412 8915 010	0412 7715 010
	RS 2. 12/15	12	1/2	6.4 (M6)	9.7+	6.0	0.8	0412 8915 012	0412 7715 012
	RS 2. 13/15	13	1/2	6.4 (M6)	9.7+	6.0	0.8	0412 8915 013	0412 7715 013
	RS 2. 14/15	14	9/16	6.4 (M6)	9.7+	6.0	0.8	0412 8915 014	0412 7715 014
	RS 2. 15/15	15	5/8	6.4 (M6)	9.7+	6.0	0.8	0412 8915 015	0412 7715 015
	RS 2. 16/15	16	5/8	6.4 (M6)	9.7+	6.0	0.8	0412 8915 016	0412 7715 016
	RS 2. 18/15	18	3/4	6.4 (M6)	9.7+	6.0	0.8	0412 8915 018	0412 7715 018
	RS 2. 19/15	19	3/4	6.4 (M6)	9.7+	6.0	0.8	0412 8915 019	0412 7715 019
	RS 2. 20/15	20	13/16	6.4 (M6)	9.7+	6.0	0.8	0412 8915 020	0412 7715 020
	RS 2. 21/15	21	13/16	6.4 (M6)	9.7+	6.0	0.8	0412 8915 021	0412 7715 021
	RS 2. 22/15	22	7/8	6.4 (M6)	9.7+	6.0	0.8	0412 8915 022	0412 7715 022
	RS 2. 23/15	23	7/8	6.4 (M6)	9.7+	6.0	0.8	0412 8915 023	0412 7715 023
	RS 2. 25/15	25	1	6.4 (M6)	9.7+	6.0	0.8	0412 8915 025	0412 7715 025
	RS 2. 26/15	26	11/16	6.4 (M6)	9.7+	6.0	0.8	0412 8915 026	0412 7715 026
	RS 2. 28/15	28	11/8	6.4 (M6)	9.7+	6.0	0.8	0412 8915 028	0412 7715 028
	RS 2. 30/15	30	13/16	6.4 (M6)	9.7+	6.0	0.8	0412 8915 030	0412 7715 030
RS 2. 32/15	32	11/4	6.4 (M6)	9.7+	6.0	0.8	0412 8915 032	0412 7715 032	
RS 2. 34/15	34	15/16	6.4 (M6)	9.7+	6.0	0.8	0412 8915 034	0412 7715 034	
RS 2. 35/15	35	13/8	6.4 (M6)	9.7+	6.0	0.8	0412 8915 035	0412 7715 035	
20	RS 2. 10/20	10	3/8	8.4 (M8)	12.5+	8.5	0.8	0412 8920 010	0412 7720 010
	RS 2. 12/20	12	1/2	8.4 (M8)	12.5+	8.5	0.8	0412 8920 012	0412 7720 012
	RS 2. 13/20	13	1/2	8.4 (M8)	12.5+	8.5	0.8	0412 8920 013	0412 7720 013
	RS 2. 14/20	14	9/16	8.4 (M8)	12.5+	8.5	0.8	0412 8920 014	0412 7720 014
	RS 2. 15/20	15	5/8	8.4 (M8)	12.5+	8.5	0.8	0412 8920 015	0412 7720 015
	RS 2. 16/20	16	5/8	8.4 (M8)	12.5+	8.5	0.8	0412 8920 016	0412 7720 016
	RS 2. 18/20	18	3/4	8.4 (M8)	12.5+	8.5	0.8	0412 8920 018	0412 7720 018
	RS 2. 19/20	19	3/4	8.4 (M8)	12.5+	8.5	0.8	0412 8920 019	0412 7720 019
	RS 2. 20/20	20	13/16	8.4 (M8)	12.5+	8.5	0.8	0412 8920 020	0412 7720 020
	RS 2. 22/20	22	7/8	8.4 (M8)	12.5+	8.5	0.8	0412 8920 022	0412 7720 022
	RS 2. 23/20	23	7/8	8.4 (M8)	12.5+	8.5	0.8	0412 8920 023	0412 7720 023
	RS 2. 24/20	24	15/16	8.4 (M8)	12.5+	8.5	0.8	0412 8920 024	0412 7720 024
	RS 2. 25/20	25	1	8.4 (M8)	12.5+	8.5	0.8	0412 8920 025	0412 7720 025
	RS 2. 28/20	28	11/8	8.4 (M8)	12.5+	8.5	1.0	0412 8920 028	0412 7720 028
	RS 2. 30/20	30	13/16	8.4 (M8)	12.5+	8.5	1.0	0412 8920 030	0412 7720 030
	RS 2. 32/20	32	11/4	8.4 (M8)	12.5+	8.5	1.0	0412 8920 032	0412 7720 032
	RS 2. 34/20	34	15/16	8.4 (M8)	12.5+	8.5	1.0	0412 8920 034	0412 7720 034
	RS 2. 35/20	35	13/8	8.4 (M8)	12.5+	8.5	1.0	0412 8920 035	0412 7720 035
RS 2. 36/20	36	17/16	8.4 (M8)	12.5+	8.5	1.0	0412 8920 036	0412 7720 036	
RS 2. 38/20	38	11/2	8.4 (M8)	12.5+	8.5	1.0	0412 8920 038	0412 7720 038	
RS 2. 40/20	40	19/16	8.4 (M8)	12.5+	8.5	1.0	0412 8920 040	0412 7720 040	

Band width 9 mm and 25 mm on request
Additional diameters on request

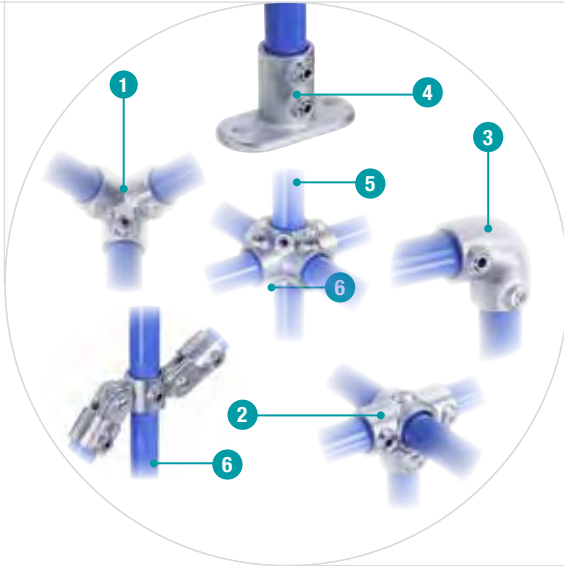

- 1** 3 ways 90° elbow
- 2** Side outlet tee
- 3** 90° elbow
- 4** Railing base flange
- 5** Four way cross
- 6** Double swivel combination

Tube clamp fittings for safety systems

Made of malleable galvanized iron to ensure strength, quality and conformity of production. NORMA Tube Clamp Fittings can be easily assembled on pipes in order to create safety systems.



NORMAFIX®

Advantages at a glance

- Stainless steel screw
- Warranty up to 1500 N/m load
- No welding, so no fire permits required
- No threading, no bolting
- Can be assembled with a simple hexagonal key
- A versatile system that allows changes on site
- Can be painted

Applications

- Handrails
- Safety rails/Protective barriers
- Fall protections
- Other applications for safety work
- Fix railings
- Machinery guard
- Playgrounds

Materials

- Malleable galvanized iron

Sleeve joint

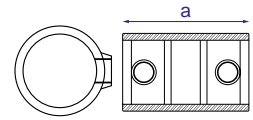

NORMAFIX® SLEEVE JOINT

Designation	Diameter in mm	a mm	Malleable galvanized iron Product No.
SLEEVE JOINT 26.9	26.9	76	0819 6301 027
SLEEVE JOINT 33.7	33.7	90	0819 6301 034
SLEEVE JOINT 42.4	42.4	100	0819 6301 042
SLEEVE JOINT 48.3	48.3	100	0819 6301 048
SLEEVE JOINT 60.3	60.3	120	0819 6301 060



Refer to page 191.

Expanding connector

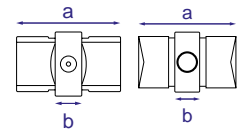
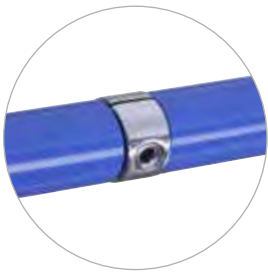

NORMAFIX® EXPANDING CONNECTOR

Designation	Diameter in mm	a mm	b mm	Malleable galvanized iron Product No.
EXPANDING CONNECTOR 33.7	33.7	78	20	0819 6302 034
EXPANDING CONNECTOR 42.4	42.4	78	20	0819 6302 042
EXPANDING CONNECTOR 48.3	48.3	78	20	0819 6302 048



Refer to page 191.

90° elbow

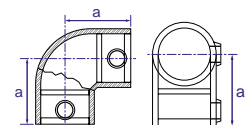

NORMAFIX® 90° ELBOW

Designation	Diameter in mm	a mm	Malleable galvanized iron Product No.
90° ELBOW 26.9	26.9	41	0819 6303 027
90° ELBOW 33.7	33.7	46	0819 6303 034
90° ELBOW 42.4	42.4	60	0819 6303 042
90° ELBOW 48.3	48.3	68	0819 6303 048
90° ELBOW 60.3	60.3	84	0819 6303 060



Refer to page 191.

Short T

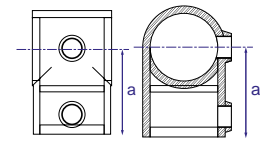

NORMAFIX® SHORT T

Designation	Diameter in mm	a mm	Malleable galvanized iron Product No.
SHORT T 26.9	26.9	41	0819 6304 027
SHORT T 33.7	33.7	46	0819 6304 034
SHORT T 42.4	42.4	60	0819 6304 042
SHORT T 48.3	48.3	68	0819 6304 048
SHORT T 60.3	60.3	84	0819 6304 060



Refer to page 191.

Long T

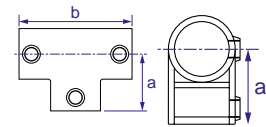

NORMAFIX® LONG T

Designation	Diameter in mm	a mm	b mm	Malleable galvanized iron Product No.
LONG T 26.9	26.9	41	82	0819 6305 027
LONG T 33.7	33.7	46	92	0819 6305 034
LONG T 42.4	42.4	60	120	0819 6305 042
LONG T 48.3	48.3	68	135	0819 6305 048
LONG T 60.3	60.3	84	168	0819 6305 060



Refer to page 191.

Wall flange

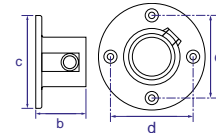

NORMAFIX® WALL FLANGE

Designation	Diameter in mm	b mm	c mm	d mm	Malleable galvanized iron Product No.
WALL FLANGE 26.9	26.9	42	83	59	0819 6306 027
WALL FLANGE 33.7	33.7	48	89	65	0819 6306 034
WALL FLANGE 42.4	42.4	51	102	76	0819 6306 042
WALL FLANGE 48.3	48.3	59	114	88.5	0819 6306 048
WALL FLANGE 60.3	60.3	64	128	97	0819 6306 060



Refer to page 191.

Railing base flange

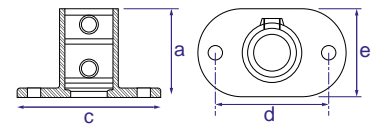

NORMAFIX® RAILING BASE FLANGE

Designation	Diameter in mm	a mm	c mm	d mm	e mm	Malleable galvanized iron Product No.
RAILING BASE FLANGE 26.9	26.9	60	105	76	52	0819 6307 027
RAILING BASE FLANGE 33.7	33.7	71	127	89	62	0819 6307 034
RAILING BASE FLANGE 42.4	42.4	84	139	101	72	0819 6307 042
RAILING BASE FLANGE 48.3	48.3	89	152	114	86	0819 6307 048
RAILING BASE FLANGE 60.3	60.3	104	165	127	96	0819 6307 060



Refer to page 191.

Handrail bracket

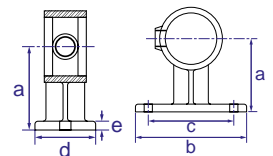

NORMAFIX® HANDRAIL BRACKET

Designation	Diameter in mm	a mm	b mm	c mm	d mm	e mm	Malleable galvanized iron Product No.
HANDRAIL BRACKET 26.9	26.9	54	77	57	44	7	0819 6308 027
HANDRAIL BRACKET 33.7	33.7	57	80	62	44	7	0819 6308 034
HANDRAIL BRACKET 42.4	42.4	62	102	82.5	45	7	0819 6308 042
HANDRAIL BRACKET 48.3	48.3	70	107	82.5	50	7	0819 6308 048



Refer to page 191.

3 ways 90° elbow

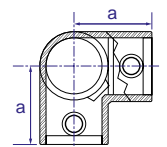

NORMAFIX® 3 WAYS 90° ELBOW

Designation	Diameter in mm	a mm	Malleable galvanized iron Product No.
3 WAYS 90° ELBOW 26.9	26.9	41	0819 6309 027
3 WAYS 90° ELBOW 33.7	33.7	48	0819 6309 034
3 WAYS 90° ELBOW 42.4	42.4	60	0819 6309 042
3 WAYS 90° ELBOW 48.3	48.3	68	0819 6309 048
3 WAYS 90° ELBOW 60.3	60.3	84	0819 6309 060



Refer to page 191.

Corner C/W through tube

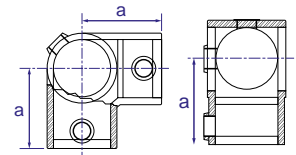

NORMAFIX® CORNER C/W THROUGH TUBE

Designation	Diameter in mm	a mm	Malleable galvanized iron Product No.
CORNER C/W THRO TUBE 26.9	26.9	41	0819 6310 027
CORNER C/W THRO TUBE 33.7	33.7	46	0819 6310 034
CORNER C/W THRO TUBE 42.4	42.4	60	0819 6310 042
CORNER C/W THRO TUBE 48.3	48.3	68	0819 6310 048
CORNER C/W THRO TUBE 60.3	60.3	84	0819 6310 060



Refer to page 191.

Two socket cross

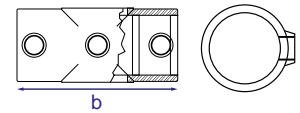

NORMAFIX® TWO SOCKET CROSS

Designation	Diameter in mm	a mm	Malleable galvanized iron Product No.
TWO SOCKET CROSS 26.9	26.9	82	0819 6311 027
TWO SOCKET CROSS 33.7	33.7	92	0819 6311 034
TWO SOCKET CROSS 42.4	42.4	120	0819 6311 042
TWO SOCKET CROSS 48.3	48.3	135	0819 6311 048
TWO SOCKET CROSS 60.3	60.3	168	0819 6311 060



Refer to page 191.

Side outlet tee

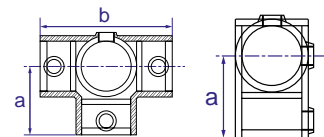

NORMAFIX® SIDE OUTLET TEE

Designation	Diameter in mm	a mm	b mm	Malleable galvanized iron Product No.
SIDE OUTLET TEE 26.9	26.9	41	82	0819 6312 027
SIDE OUTLET TEE 33.7	33.7	46	92	0819 6312 034
SIDE OUTLET TEE 42.4	42.4	60	120	0819 6312 042
SIDE OUTLET TEE 48.3	48.3	68	136	0819 6312 048
SIDE OUTLET TEE 60.3	60.3	84.5	169	0819 6312 060



Refer to page 191.

Four way cross and center

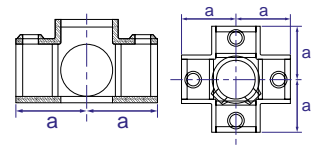

NORMAFIX® FOUR WAY CROSS AND CENTER

Designation	Diameter in mm	a mm	Malleable galvanized iron Product No.
FOUR WAY CROSS AND CENTER 26.9	26.9	41	0819 6313 027
FOUR WAY CROSS AND CENTER 33.7	33.7	46	0819 6313 034
FOUR WAY CROSS AND CENTER 42.4	42.4	60	0819 6313 044
FOUR WAY CROSS AND CENTER 48.3	48.3	68	0319 6313 048



Refer to page 191.

Fixing pad

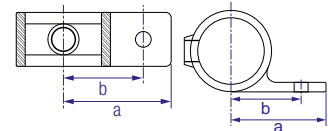

NORMAFIX® FIXING PAD

Designation	Diameter in mm	a mm	b mm	Malleable galvanized iron Product No.
FIXING PAD 33.7	33.7	60	43	0819 6314 034
FIXING PAD 42.4	42.4	66	48	0819 6314 042
FIXING PAD 48.3	48.3	70	52	0819 6314 048



Refer to page 191.

Double wall coupler

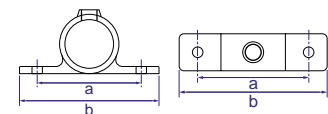

NORMAFIX® DOUBLE WALL COUPLER

Designation	Diameter in mm	a mm	b mm	Malleable galvanized iron Product No.
DOUBLE WALL COUPLER 33.7	33.7	86	120	0819 6315 034
DOUBLE WALL COUPLER 42.4	42.4	95	130	0819 6315 042
DOUBLE WALL COUPLER 48.3	48.3	104	140	0819 6315 048



Refer to page 191.

Male swivel

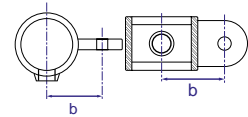

NORMAFIX® MALE SWIVEL

Designation	Diameter in mm	b mm	Malleable galvanized iron Product No.
MALE SWIVEL 33.7	33.7	43.5	0819 6316 034
MALE SWIVEL 42.4	42.4	48	0819 6316 042
MALE SWIVEL 48.3	48.3	53	0819 6316 048
MALE SWIVEL 60.3	60.3	60	0819 6316 060



Refer to page 191.

Female swivel

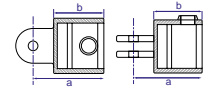

NORMAFIX® FEMALE SWIVEL

Designation	Diameter in mm	a mm	b mm	Malleable galvanized iron Product No.
FEMALE SWIVEL 33.7	33.7	61	38	0819 6317 034
FEMALE SWIVEL 42.4	42.4	69	46	0819 6317 042
FEMALE SWIVEL 48.3	48.3	77	55	0819 6317 048
FEMALE SWIVEL 60.3	60.3	89	65	0819 6317 060



Refer to page 191.

Gate eye

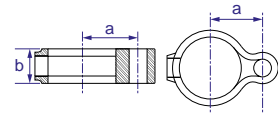

NORMAFIX® GATE EYE

Designation	Diameter in mm	a mm	b mm	Malleable galvanized iron Product No.
GATE EYE 33.7	33.7	33	25.5	0819 6318 034
GATE EYE 42.4	42.4	38	25	0819 6318 042
GATE EYE 48.3	48.3	41	25	0819 6318 048



Refer to page 191.

Gate hinge

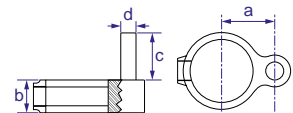

NORMAFIX® GATE HINGE

Designation	Diameter in mm	a mm	b mm	c mm	d mm	Malleable galvanized iron Product No.
GATE HINGE 33.7	33.7	33	25.5	38	12	0819 6319 034
GATE HINGE 42.4	42.4	38	25	38	12	0819 6319 042
GATE HINGE 48.3	48.3	25	25	38	12	0819 6319 048



Refer to page 191.

Double male swivel

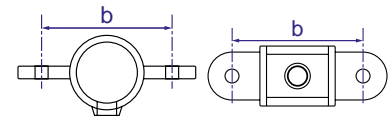

NORMAFIX® DOUBLE MALE SWIVEL

Designation	Diameter in mm	b mm	Malleable galvanized iron Product No.
DOUBLE MALE SWIVEL 33.7	33.7	84	0819 6320 034
DOUBLE MALE SWIVEL 42.4	42.4	95	0819 6320 042
DOUBLE MALE SWIVEL 48.3	48.3	105	0819 6320 048
DOUBLE MALE SWIVEL 60.3	60.3	124	0819 6320 060



Refer to page 191.

90° corner male swivel

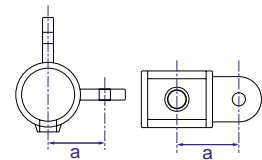

NORMAFIX® 90° CORNER MALE SWIVEL

Designation	Diameter in mm	a mm	Malleable galvanized iron Product No.
90° CORNER MALE SWIVEL 33.7	33.7	43.5	0819 6321 034
90° CORNER MALE SWIVEL 42.4	42.4	48	0819 6321 042
90° CORNER MALE SWIVEL 48.3	48.3	53	0819 6321 048
90° CORNER MALE SWIVEL 60.3	60.3	62	0819 6321 060



Refer to page 191.

90° Crossover

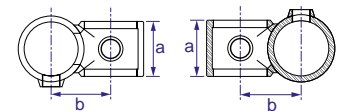

NORMAFIX® 90° CROSSOVER

Designation	Diameter in mm	a mm	b mm	Material: Malleable galvanized iron Product No.
90° CROSSOVER 26.9	26.9	31.5	38	0819 6322 027
90° CROSSOVER 33.7	33.7	38.5	41	0819 6322 034
90° CROSSOVER 42.4	42.4	46	49.5	0819 6322 042
90° CROSSOVER 48.3	48.3	51	55	0819 6322 048
90° CROSSOVER 60.3	60.3	61	67	0819 6322 060



Refer to page 191.

Single swivel combination

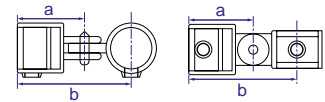

NORMAFIX® SINGLE SWIVEL COMBINATION

Designation	Diameter in mm	a mm	b mm	Malleable galvanized iron Product No.
SINGLE SWIVEL COMBINATION 26.9	26.9	61	106	0819 6323 027
SINGLE SWIVEL COMBINATION 33.7	33.7	61	104.5	0819 6323 034
SINGLE SWIVEL COMBINATION 42.4	42.4	69	117	0819 6323 042
SINGLE SWIVEL COMBINATION 48.3	48.3	77	130	0819 6323 048
SINGLE SWIVEL COMBINATION 60.3	60.3	89	152	0819 6323 060



Refer to page 191.

Base swivel combination

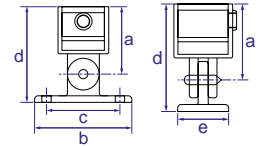

NORMAFIX® BASE SWIVEL COMBINATION

Designation	Diameter in mm	a mm	b mm	c mm	d mm	e mm	Malleable galvanized iron Product No.
BASE SWIVEL COMBINATION 33.7	33.7	61	112	85	93	52	0819 6324 034
BASE SWIVEL COMBINATION 42.4	42.4	69	112	85	98	52	0819 6324 042
BASE SWIVEL COMBINATION 48.3	48.3	77	112	85	109	52	0819 6324 048
BASE SWIVEL COMBINATION 60.3	60.3	89	112	85	121	152	0819 6324 060



Refer to page 191.

Double swivel combination

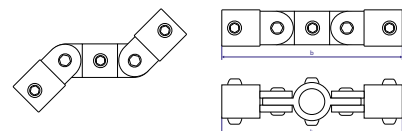

NORMAFIX® DOUBLE SWIVEL COMBINATION

Designation	Diameter in mm	b mm	Malleable galvanized iron Product No.
DOUBLE SWIVEL COMBINATION 33.7	33.7	208	0819 6325 034
DOUBLE SWIVEL COMBINATION 42.4	42.4	228	0819 6325 042
DOUBLE SWIVEL COMBINATION 48.3	48.3	259	0819 6325 048



Refer to page 191.

90° Corner swivel combination

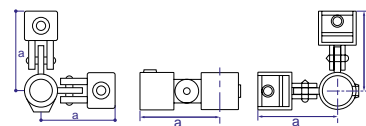

NORMAFIX® 90° CORNER SWIVEL COMBINATION

Designation	Diameter in mm	a mm	Malleable galvanized iron Product No.
90° CORNER SWIVEL COMBINATION 33.7	33.7	104.5	0819 6326 034
90° CORNER SWIVEL COMBINATION 42.4	42.4	117	0819 6326 042
90° CORNER SWIVEL COMBINATION 48.3	48.3	130	0819 6326 048



Refer to page 191.

Short tee swivel

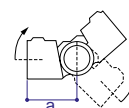

NORMAFIX® SHORT TEE SWIVEL

Designation	Diameter in mm	a mm	Malleable galvanized iron Product No.
SHORT TEE SWIVEL 26.9	26.9	53	0819 6327 027
SHORT TEE SWIVEL 33.7	33.7	59	0819 6327 034
SHORT TEE SWIVEL 42.4	42.4	73	0819 6327 042
SHORT TEE SWIVEL 48.3	48.3	93	0819 6327 048



Refer to page 191.

Clamp on tee

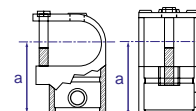

NORMAFIX® CLAMP ON TEE

Designation	Diameter in mm	a mm	Malleable galvanized iron Product No.
CLAMP ON TEE 33.7	33.7	52.5	0819 6328 034
CLAMP ON TEE 42.4	42.4	67	0819 6328 042
CLAMP ON TEE 48.3	48.3	76.5	0819 6327 048



Refer to page 191.

Fence building clamp

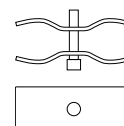

NORMAFIX® FENCE BUILDING CLAMP

Designation	Diameter in mm	Electrolytic yellow passivated Product No.
FENCE BUILDING CLAMP	48	0819 6333 048



Refer to page 191.



- 1 2 bolts for fixing the clamp on the post
- 2 Round shaped to adapt to the form of the support

Universal traffic sign fixation

Mainly used to hold road signs on a diversity of metal posts or lamppost diameters.

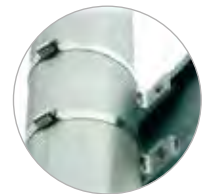

NORMAFIX®

Advantages at a glance

- Including 2 bolts
- To be used with a worm drive hose clamp

Applications

- Traffic signs industry

Materials

- Aluminum

Technical data & Ordering information

NORMAFIX® ALU BAND CLAMP			
Designation	Length	Number of bolts	Aluminum Product No.
ALU BAND CLAMP	82	2	0560 7563 082
ALU BAND CLAMP	120	2	0560 7563 120



- 1 Dimple on both sides to insert the worm drive hose clamp

Universal traffic sign fixation

Mainly used to hold road signs on a diversity of metal posts or lamppost diameters.



Advantages at a glance

- To be used with a worm drive hose clamp

Applications

- Traffic signs industry

Materials

- Stainless steel

Technical data & Ordering information

NORMAFIX® UNIVERSAL UCC CLAMP

Designation	Stainless steel Product No.
UNIVERSAL UCC CLAMP	0560 7620 000

For a helping hand in industrial, commercial and private applications – **Hose Connectors**

NORMAPLAST® plastic hose connectors – the NORMA® range of products for rapidly connecting hoses and pipes – are the helping hands that no one working in industrial, commercial or private applications should be without.





- 1 NORMAPLAST YN**
– Y plastic pipe connectors
- 2 NORMAPLAST TS**
– Equal T push-on connectors
- 3 NORMAPLAST GES**
– Straight taper thread connectors
- 4 NORMAPLAST TES**
– T-taper thread connector
– Equal bend – EB
- 5 NORMAPLAST GRS**
– Reducing straight push-on connectors
- 6 NORMAPLAST WN**
– Elbow plastic pipe connectors
- 7 NORMAPLAST GN**
– Straight plastic pipe connectors
- 8 NORMAPLAST KS**
– Cross push-on connectors
- 9 NORMAPLAST GS**
– Straight push-on connectors

Hose connectors

NORMAPLAST® SV products are proven plastic hose and pipe connection components that create secure, reliable and affordable connections in lines used for transporting media.

NORMAPLAST® SV hose and pipe connectors are used in the automotive construction industry as well as practically every other industrial sector.

Advantages at a glance

- Extremely strong
- Durable
- Low weight
- Can be used for damping/absorption
- Resistant to abrasion
- Highly resistant to impact

Applications

- Machine building
- White goods
- Chemical industry
- Irrigation systems
- Food and beverage industry
- Railway industry
- Agricultural machines
- Building machines
- Engine manufacturing
- Pump and filter

Materials

Materials				
	PP	POM	PA6	PA with glass fiber
Mechanical Properties	Moplen HP501H	Polyacetal copolymer standard material hose connectors	Polyamide unreinforced standard material threaded connectors	Polyamide reinforced standard material pipe connectors
Operation temperature	0°C to +80°C short term (up to 1h) max. +100°C	–40°C to 80°C, short-term (up to 1h) 110°C	–40°C to 90°C, short-term (up to 1h) 120°C	–40°C to 120°C, short-term (up to 1h) 150°C
Max. admissible pressure	10bar	10bar	10bar	10bar

Applications	Recommended material range
Food area / drinking water area / chemical area	>POM<
Chemical area	>PP<
Chemical area (with aggressive media)	>PVDF<
Fuel / UREA (AdBlue) crank case ventilation	>PA12-GF30<
Cooling water / Windshield washer fluid	>PA66-GF30<
Air (Vacuum brake, Secondary air) TOC (Oil cooler, transmission oil)	>PA6-GF30<

Thermal properties

In the case of threaded spigots, the expansion coefficient 100×10^{-6} for thermoplastic material must be taken into consideration if temperature fluctuations occur. Our standard materials are classified in accordance with the UL (Underwriters Laboratories) system as follows:

- Flammability rating (UL94)
- POM, PP, PA6, PA6.6, and PA12: HB (Horizontal Burning)

Materials

Chemical properties of the plastics used								
No.	Chemical substance	Concentration	Temperature	POM	PP	PA 6	PA 6.6	PA 12
1	Acetone	100%	20 °C/50 °C	1/3	1/1	1/0	1/0	1/0
2	Formic acid	98-100%	20 °C/50 °C	4/4	1/3	4/4	4/4	4/4
3	Ammonium hydroxide (spirits of ammonia)	Any	20 °C/50 °C	1/2	1/1	1/0	1/0	1/0
4	Benzene; normal and super unleaded	Commercial	20 °C/50 °C	1/1	3/4	1/1	1/1	1/1
5	Benzene, benzene hydrocarbons	100%	20 °C/50 °C	3/3	3/4	1/0	1/0	1/0
6	Bleaching lye (12.5% active chlorine)	Aqueous solution 12.5%	20 °C/50 °C	4/4	3/3	4/4	4/4	3/3
7	Brake fluid (DOT4)	Commercial	20 °C/50 °C	1/1	1/1	1/1	1/1	1/1
8	Butanol	Technically pure	20 °C/50 °C	1/2	1/1	1/0	1/0	1/0
9	Chlorine, chlorine water	Commercial	20 °C/50 °C	4/4	4/4	4/4	4/4	4/4
10	Disinfectant phenols	Diluted solution	20 °C/50 °C	4/4	1/1	4/4	4/4	4/4
11	Diesel fuel, diesel oil	Commercial	20 °C/50 °C	1/1	1/3	1/1	1/1	1/1
12	Decalcifier	Aqueous solution ~10%	20 °C/50 °C	4/4	1/1	2/3	2/3	2/3
13	Photographic developer (1:100)	Commercial	20 °C/50 °C	1/1	1/1	4/4	4/4	4/4
14	Natural gas (town gas, coal gas)	Commercial	20 °C/50 °C	1/1	1/1	1/1	1/1	1/1
15	Crude oil	Commercial	20 °C/50 °C	1/1	3/3	1/1	1/1	1/1
16	Acetic acid (glacial acetic acid)	90%	20 °C/50 °C	4/4	1/2	4/4	4/4	4/4
17	Ethyl alcohol	96% (tech. pure)	20 °C/50 °C	1/2	1/1	1/0	1/0	1/0
18	Photographic emulsion	Commercial	20 °C/50 °C	1/0	1/1	1/0	1/0	1/0
19	Fruit juices	Commercial	20 °C/50 °C	1/1	1/1	1/1	1/1	1/1
20	Glycerine	Technically pure	20 °C/50 °C	1/1	1/1	1/1	1/1	1/1
21	Glysantin	Commercial	20 °C/50 °C	1/1	1/1	3/3	3/3	3/3
22	Heating oil	Commercial	20 °C/50 °C	1/1	1/3	1/1	1/1	1/1
23	Hydraulic fluid	Commercial	20 °C/50 °C	1/0	1/3	1/1	1/1	1/1
24	Carbon dioxide, carbonic acid	Technically pure, saturated	20 °C/50 °C	1/1	1/1	1/0	1/0	1/0
25	Coolants (based on glycol)	Commercial	20 °C/50 °C	1/1	1/1	3/3	1/1	1/1
26	Methane	Technically pure	20 °C/50 °C	1/1	1/1	1/1	1/1	1/1
27	Methanol	Technically pure	20 °C/50 °C	1/1	1/1	1/1	1/1	3/3
28	Methyl ethyl ketone	100%	20 °C/50 °C	3/3	1/3	1/0	1/0	1/1
29	Engine oils (HD)	Commercial	20 °C/50 °C	1/1	1/3	1/1	1/1	1/1
30	Sodium hydroxide (lye; caustic soda)	40%	20 °C/50 °C	1/1	1/1	1/1	1/1	1/1
31	Ozone	Gaseous	20 °C/50 °C	4/4	3/4	3/4	3/4	3/4
32	Propanol	Technically pure	20 °C/50 °C	1/1	1/1	1/1	1/1	2/2
33	Propane (liquefied gas)	Liquid	20 °C/50 °C	1/1	1/1	1/0	1/0	1/0
34	Propene	96%	20 °C/50 °C	1/0	1/1	1/0	1/0	1/0
35	Rape oil (rape oil methyl ester)	Commercial	20 °C/50 °C	1/1	2/2 (*)	1/1	1/1	1/1
36	Hydrochloric acid	Aqueous, 10%	20 °C/50 °C	4/4	1/1	4/4	4/4	3/3
37	Lubricating oil/grease, soft soap	Commercial	20 °C/50 °C	1/1	1/2	1/1	1/1	1/1
38	Sulphuric acid	Aqueous, 10%	20 °C/50 °C	4/4	1/2	3/3	3/3	2/2
39	De-icing salt solution (brine)	Saturated	20 °C/50 °C	1/2	1/1	1/1	1/1	1/1
40	Soap suds (dissolved detergent)	Diluted solution	20 °C/50 °C	1/1	2/2 (*)	1/1	1/1	1/1
41	Water (drinking, river, sea)	Technically pure	20 °C/50 °C	1/1	1/1	1/1	1/1	1/1
42	Citric acid	10%	20 °C/50 °C	2/4	1/1	1/0	1/0	1/0

Explanation of abbreviations:

POM = Acetal copolymer

PP = Polypropylene

PA = Polyamide

0 = No data available/Not possible to make an appropriate statement

1 = Highly stable/suitable
(change in dimensions: none or negligible and reversible; no damage even after extended period)

2 = Very stable/suitable
(change in dimensions after short period: none or negligible and reversible; little change in dimensions, possibly irreversible change to properties after extended period)

3 = Limited stability
(considerable changes to dimensions, possibly irreversible change to properties after extended period)

4 = Unstable/unsuitable
(soluble or serious effects after a short period)

(*) Moisture expansion

The specifications in this catalogue are based on tests carried out by the granular material manufacturer. They are intended to serve as guidelines for our customers, but cannot simply be applied to any case in which customers expose these products to demands which fall outside the scope of the tests performed. On no account should this be done without first consulting us.

Our customers must perform their own tests to determine whether our NORMAPLAST® plastic hose connecting components are suitable for the application they are intended to be used in. We will be happy to offer any advice or information required.

Our liability is subject exclusively to our terms of delivery and sale. Special versions can be produced if an appropriate quantity of the component in question is ordered.

Please contact the relevant manufacturer before using a product as a safety component.



Use as a hose connector

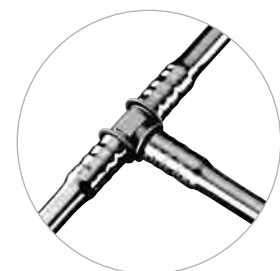

Use as a push-on connector

GES – Straight taper thread connectors

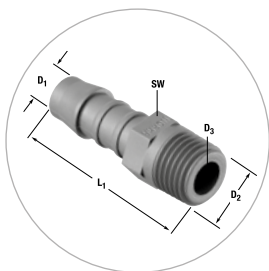

Nominal size ID hose (in mm)	Designation	D ₁	D ₂	D ₃	L ₁ ~	SW	Material PA6 Product No.
3	GES 3 / M 5	3	M 5 cyl	2.5	19.5	6	0710 8952 003
4	GES 4 / M 8 x 1	4	M 8 x 1 con.	2.5	27	10	0710 8901 004
	GES 4 / M 8 x 1.25	4	M 8 x 1.25 con.	2.5	27	10	0710 8902 004
	GES 4 / M 10 x 1	4	M 10 x 1 con.	2.5	27	10	0710 8903 004
	GES 4 / M 12 x 1.5	4	M 12 x 1.5 con.	2.5	32	14	0710 8904 004
	GES 4 / M 14 x 1.5	4	M 14 x 1.5 con.	2.5	32	14	0710 8905 004
	GES 4 / R 1/8	4	R 1/8 con.	2.5	27	10	0710 8910 004
	GES 4 / R 1/4	4	R 1/4 con.	2.5	32	14	0710 8911 004
	GES 4 / 1/8 NPT	4	1/8 NPT	2.5	29	10	0710 8917 004
GES 4 / 1/4 NPT	4	1/4 NPT	2.5	35	14	0710 8918 004	
5	GES 5 / M 12 x 1.5	5	M 12 x 1.5 con.	3	36	14	0710 8904 005
	GES 5 / M 14 x 1.5	5	M 14 x 1.5 con.	3	36	14	0710 8905 005
	GES 5 / R 1/4	5	R 1/4 con.	3	36	14	0710 8911 005
	GES 5 / R 1/4 NPT	5	R 1/4 NPT	3	39	14	0710 8918 005
6	GES 6 / M 10 x 1	6	M 10 x 1 con.	4	32.5	10	0710 8903 006
	GES 6 / M 12 x 1.5	6	M 12 x 1.5 con.	4	37.5	14	0710 8904 006
	GES 6 / M 14 x 1.5	6	M 14 x 1.5 con.	4	36.5	14	0710 8905 006
	GES 6 / R 1/8	6	R 1/8 con.	4	32.5	10	0710 8910 006
	GES 6 / R 1/4	6	R 1/4 con.	4	37.5	14	0710 8911 006
	GES 6 / R 3/8	6	R 3/8 con.	4	39	17	0710 8912 006
	GES 6 / 1/8 NPT	6	1/8 NPT	4	34.5	10	0710 8917 006
	GES 6 / 1/4 NPT	6	1/4 NPT	4	40.5	14	0710 8918 006
8	GES 8 / M 10 x 1	8	M 10 x 1 con.	5.6	38	14	0710 8903 008
	GES 8 / M 12 x 1.5	8	M 12 x 1.5 con.	5.6	41	14	0710 8904 008
	GES 8 / M 14 x 1.5	8	M 14 x 1.5 con.	5.6	41	14	0710 8905 008
	GES 8 / M 18 x 1.5	8	M 18 x 1.5 con.	5.6	49	22	0710 8907 008
	GES 8 / M 22 x 1.5	8	M 22 x 1.5 con.	5.6	49	22	0710 8949 008
	GES 8 / M 26 x 1.5	8	M 26 x 1.5 con.	5.6	58	27	0710 8908 008
	GES 8 / R 1/8	8	R 1/8 con.	5.6	38	14	0710 8910 008
	GES 8 / R 1/4	8	R 1/4 con.	5.6	41	14	0710 8911 008
	GES 8 / R 3/8	8	R 3/8 con.	5.6	41	17	0710 8912 008
	GES 8 / R 1/2	8	R 1/2 con.	5.6	49	22	0710 8913 008
GES 8 / 1/4 NPT	8	1/4 NPT	5.6	44	14	0710 8918 008	
10	GES 10 / M 12 x 1.5	10	M 12 x 1.5 con.	7	43.5	14	0710 8904 010
	GES 10 / M 14 x 1.5	10	M 14 x 1.5 con.	7	43.5	14	0710 8905 010
	GES 10 / M 16 x 1.5	10	M 16 x 1.5 con.	7	43.5	17	0710 8906 010
	GES 10 / R 1/4	10	R 1/4 con.	7	43.5	14	0710 8911 010
	GES 10 / R 3/8	10	R 3/8 con.	7	43.5	17	0710 8912 010
	GES 10 / 1/4 NPT	10	1/4 NPT	7	46.5	14	0710 8918 010
GES 10 / 3/8 NPT	10	3/8 NPT	7	46.5	17	0710 8919 010	
12	GES 12 / M 16 x 1.5	12	M 16 x 1.5 con.	8.6	45.5	17	0710 8906 012
	GES 12 / M 18 x 1.5	12	M 18 x 1.5 con.	8.6	54	22	0710 8907 012
	GES 12 / M 22 x 1.5	12	M 22 x 1.5 con.	8.6	54	22	0710 8949 012
	GES 12 / M 26 x 1.5	12	M 26 x 1.5 con.	8.6	58	27	0710 8909 012
	GES 12 / R 3/8	12	R 3/8 con.	8.6	45.5	17	0710 8912 012
	GES 12 / R 1/2	12	R 1/2 con.	8.6	54	22	0710 8913 012
GES 12 / 3/8 NPT	12	3/8 NPT	8.6	48	17	0710 8919 012	
14	GES 14 / M 20 x 1.5	14	M 20 x 1.5 con.	10	56	22	0710 8908 014
	GES 14 / R 3/8	14	R 3/8 con.	10	56	17	0710 8912 014
	GES 14 / R 1/2	14	R 1/2 con.	10	56	22	0710 8913 014
	GES 14 / R 1/2 NPT	14	R 1/2 NPT	10	58	22	0710 8920 014
16	GES 16 / M 26 x 1.5	16	M 26 x 1.5 con.	12	58	27	0710 8909 016
	GES 16 / R 1/2	16	R 1/2 con.	12	58	22	0710 8913 016
	GES 16 / R 3/4	16	R 3/4 con.	12	58	27	0710 8914 016
19	GES 19 / M 26 x 1.5	19	M 26 x 1.5 con.	15	58	27	0710 8909 019
	GES 19 / R 3/4	19	R 3/4 con.	15	58	27	0710 8914 019
25	GES 25 / R 1	25	R 1 con.	21	69	32	0710 8915 025

NORMAPLAST®

BST – Blanking plugs with screw-in thread

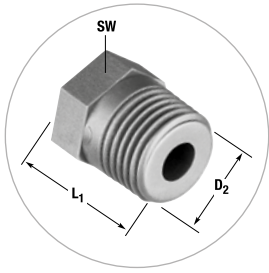

Designation	D ₂	L ₁ ~	SW	Material PA6 Product No.
BST M 8 x 1	M 8 x 1 con.	13	10	0711 8901 000
BST M 10 x 1	M 10 x 1 con.	13.5	10	0711 8903 000
BST M 12 x 1.5	M 12 x 1.5 con.	17.5	14	0711 8904 000
BST M 14 x 1.5	M 14 x 1.5 con.	17.5	14	0711 8905 000
BST M 18 x 1.5	M 18 x 1.5 con.	26.5	22	0711 8907 000
BST M 20 x 1.5	M 20 x 1.5 con.	25	22	0711 8908 000
BST M 26 x 1.5	M 26 x 1.5 con.	26.5	22	0711 8909 000
BST R 1/8	R 1/8 con.	26	22	0711 8910 000
BST R 1/4	R 1/4 con.	12.5	10	0711 8911 000
BST R 3/8	R 3/8 con.	17.5	14	0711 8912 000
BST R 1/2	R 1/2 con.	27	17	0711 8913 000
BST 1/8 NPT	1/8 NPT	27.5	22	0711 8917 000
BST 1/4 NPT	1/4 NPT	14	10	0711 8918 000
BST M 22 x 1.5	M 22 x 1.5 con.	20.5	14	0711 8949 000

TES – T-taper thread connectors

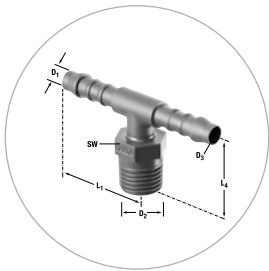

Nominal size ID hose (in mm)	Designation	D ₁	D ₂	D ₃	L ₁ ~	L ₂ ~	SW	Material PA6 Product No.
4	TES 4 / M 8 x 1	4	M 8 x 1 con.	2.5	21	18	10	0720 8901 004
	TES 4 / M 10 x 1	4	M 10 x 1 con.	2.5	21	18	10	0720 8903 004
	TES 4 / M 12 x 1.5	4	M 12 x 1.5 con.	2.9	21	23	14	0720 8904 004
	TES 4 / R 1/8	4	R 1/8 con.	2.5	21	18	10	0720 8910 004
	TES 4 / R 1/4	4	R 1/4 con.	2.5	21	23	14	0720 8911 004
	TES 4 / 1/8 NPT	4	1/8 NPT	2.5	21	20	10	0720 8917 004
	TES 4 / 1/4 NPT	4	1/4 NPT	2.5	21	26	14	0720 8918 004
6	TES 6 / M 10 x 1	6	M 10 x 1 con.	4	28.5	21	10	0720 8903 006
	TES 6 / M 12 x 1.5	6	M 12 x 1.5 con.	4	28.5	26	14	0720 8904 006
	TES 6 / R 1/8	6	R 1/8 con.	4	28.5	21	10	0720 8910 006
	TES 6 / R 1/4	6	R 1/4 con.	4	28.5	26	14	0720 8911 006
	TES 6 / 1/8 NPT	6	1/8 NPT	4	28.5	23	10	0720 8917 006
	TES 6 / 1/4 NPT	6	1/4 NPT	4	28.5	29	14	0720 8918 006
8	TES 8 / M 12 x 1.5	8	M 12 x 1.5 con.	5.6	33	27.5	14	0720 8904 008
	TES 8 / M 14 x 1.5	8	M 14 x 1.5 con.	5.6	33	27.5	14	0720 8905 008
	TES 8 / R 1/4	8	R 1/4 con.	5.6	33	27.5	14	0720 8911 008
	TES 8 / 1/4NPT	8	1/4NPT	5.6	33	30.5	14	0720 8918 008
10	TES 10 / R 3/8	10	R 3/8 con.	7	35.5	30	17	0720 8912 010

WES – Elbow taper thread connectors

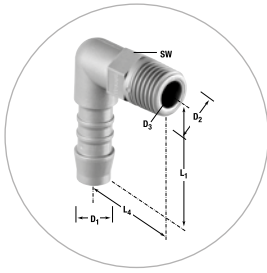

Nominal size ID hose (in mm)	Designation	D ₁	D ₂	D ₃	L ₁ ~	L ₂ ~	SW	Material PA6 Product No.
3	WES 3 / M 5 cyl.	3	M 5 cyl.	2.5	12.5	12.5	6	0730 8952 003
4	WES 4 / M 8 x 1	4	M 8 x 1 con.	2.7	21	16	10	0730 8901 004
	WES 4 / M 10 x 1	4	M 10 x 1 con.	2.7	21	16	10	0730 8903 004
	WES 4 / M 12 x 1.5	4	M 12 x 1.5 con.	2.7	21	25	14	0730 8904 004
	WES 4 / M 14 x 1.5	4	M 14 x 1.5 con.	2.7	21	25	14	0730 8905 004
	WES 4 / R 1/8	4	R 1/8 con.	2.7	21	16	10	0730 8910 004
	WES 4 / R 1/4	4	R 1/4 con.	2.7	21	25	14	0730 8911 004
	WES 4 / 1/8 NPT	4	1/8 NPT	2.7	21	18	10	0730 8917 004
WES 4 / 1/4 NPT	4	1/4 NPT	2.7	21	28	14	0730 8918 004	
6	WES 6 / M 10 x 1	6	M 10 x 1 con.	4	28.5	21	10	0730 8903 006
	WES 6 / M 12 x 1.5	6	M 12 x 1.5 con.	4	28.5	26	14	0730 8904 006
	WES 6 / R 1/8	6	R 1/8 con.	4	28.5	21	10	0730 8910 006
	WES 6 / R 1/4	6	R 1/4 con.	4	28.5	26	14	0730 8911 006
	WES 6 / R 3/8	6	R 3/8 con.	4	28.5	27	17	0730 8912 006
	WES 6 / 1/8 NPT	6	1/8 NPT	4	28.5	23	10	0730 8917 006
	WES 6 / 1/4 NPT	6	1/4 NPT	4	28.5	29	14	0730 8918 006
8	WES 8 / M 10 x 1	8	M 10 x 1 con.	5.6	33	23.5	14	0730 8903 008
	WES 8 / M 12 x 1.5	8	M 12 x 1.5 con.	5.6	33	27.5	14	0730 8904 008
	WES 8 / M 14 x 1.5	8	M 14 x 1.5 con.	5.6	33	27.5	14	0730 8905 008
	WES 8 / M 16 x 1.5	8	M 16 x 1.5 con.	5.6	36	27.5	17	0730 8906 008
	WES 8 / M 18 x 1.5	8	M 18 x 1.5 con.	5.6	36	36	19	0730 8907 008
	WES 8 / M 22 x 1.5	8	M 22 x 1.5 con.	5.6	36	36	22	0730 8949 008
	WES 8 / R 1/8	8	R 1/8 con.	5.6	33	23	14	0730 8910 008
	WES 8 / R 1/4	8	R 1/4 con.	5.6	33	27.5	14	0730 8911 008
	WES 8 / R 3/8	8	R 3/8 con.	5.6	36	31	17	0730 8912 008
	WES 8 / R 1/2	8	R 1/2 con.	5.6	36	36	22	0730 8913 008
	WES 8 / 1/4 NPT	8	1/4 NPT	5.6	33	30.5	14	0730 8918 008
10	WES 10 / M 14 x 1.5	10	M 14 x 1.5 con.	7	38	30	14	0730 8905 010
	WES 10 / R 1/4	10	R 1/4	7	38	30	14	0730 8911 010
	WES 10 / R 3/8	10	R 3/8	7	38	30	17	0730 8912 010
	WES 10 / 1/2 NPT	10	1/2 NPT	7	38	38	22	0730 8920 010
12	WES 12 / M 16 x 1.5	12	M 16 x 1.5 con.	8.6	40.5	30	17	0730 8906 012
	WES 12 / M 18 x 1.5	12	M 18 x 1.5 con.	8.6	40.5	36	19	0730 8907 012
	WES 12 / M 22 x 1.5	12	M 22 x 1.5 con.	8.6	40.5	36	22	0730 8949 012
	WES 12 / M 26 x 1.5	12	M 26 x 1.5 con.	8.6	40.5	36	22	0730 8909 012
	WES 12 / R 3/8	12	R 3/8	8.6	40.5	31	17	0730 8912 012
	WES 12 / R 1/2	12	R 1/2	8.6	40.5	36	22	0730 8913 012
	WES 12 / 3/8 NPT	12	3/8 NPT	8.6	40.5	31	19	0730 8919 012
19	WES 19 / M 24 x 2	19	M 24 x 2 con.	15	45	42.8	27	0730 8953 019
	WES 19 / R 3/4	19	R 3/4 con.	15	45.5	42.8	27	0730 8914 019
25	WES 25 / R 1	25	R 1 con.	21	60	49	32	0730 8915 025

GS – Straight push-on connectors

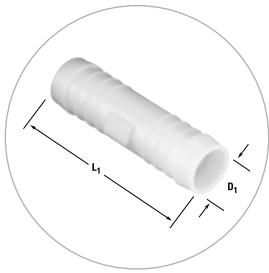

Nominal size ID hose (in mm)	Designation	D ₁	D ₂	L ₁ ~	Material POM Product No.
3	GS 3	3	2.5	25	0750 8900 003
4	GS 4	4	2.7	35	0750 8900 004
5	GS 5	5	3	45	0750 8900 005
6	GS 6	6	4	49	0750 8900 006
8	GS 8	8	5.6	56	0750 8900 008
10	GS 10	10	7	63	0750 8900 010
12	GS 12	12	8.6	66.5	0750 8900 012
13	GS 13	13	8.6	73	0750 8900 013
14	GS 14	14	10	79	0750 8900 014
16	GS 16	16	12	75	0750 8900 016
19	GS 19	19	15	76	0750 8900 019
25	GS 25	25	21	95	0750 8900 025



Refer to pages 181 and 182.

GRS – Reducing straight push-on connectors

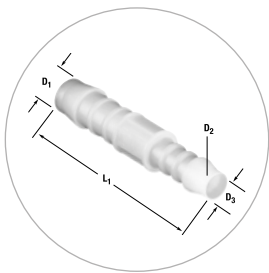

Nominal size ID hose (in mm)	Designation	D ₁	D ₂	D ₃	L ₁ ~	Material POM Product No.
4 - 3	GRS 4 - 3	4	2.5	3	30	0751 8904 003
5 - 4	GRS 5 - 4	5	2.7	3	41	0751 8905 004
6 - 4	GRS 6 - 4	6	2.7	4	42.5	0751 8906 004
8 - 4	GRS 8 - 4	8	2.7	4	48	0751 8908 004
8 - 6	GRS 8 - 6	8	4	6	54	0751 8908 006
10 - 6	GRS 10 - 6	10	4	6	58	0751 8910 006
10 - 8	GRS 10 - 8	10	5.6	8	60.5	0751 8910 008
12 - 8	GRS 12 - 8	12	5.6	8	62.5	0751 8912 008
12 - 10	GRS 12 - 10	12	7	10	64	0751 8912 010

TS – Equal T push-on connectors

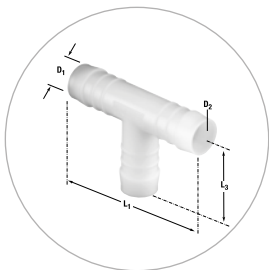

Nominal size ID hose (in mm)	Designation	D ₁	D ₂	L ₁ ~	L ₂ ~	Material POM Product No.
3	TS 3	3	2.5	25	12.5	0760 8900 003
4	TS 4	4	2.7	35	19.5	0760 8900 004
5	TS 5	5	3	42	22	0760 8900 005
6	TS 6	6	4	50	26	0760 8900 006
7	TS 7	7	5	50	26	0760 8900 007
8	TS 8	8	5.6	58	30	0760 8900 008
10	TS 10	10	7	62.5	33.5	0760 8900 010
12	TS 12	12	8.6	69	36	0760 8900 012
13	TS 13	13	8.6	68	36	0760 8900 013
14	TS 14	14	10	77.5	41.5	0760 8900 014
15	TS 15	15	11	79.5	43.5	0760 8900 015
16	TS 16	16	12	81	45	0760 8900 016
19	TS 19	19	15	85	45	0760 8900 019
25	TS 25	25	21	105	52.5	0760 8900 025



Refer to pages 181 and 182.

KS – Cross push-on connectors

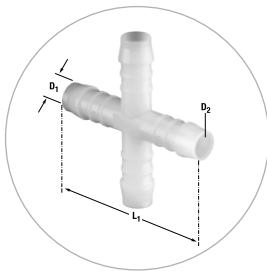

Nominal size ID hose (in mm)	Designation	D ₁	D ₂	L ₁ ~	Material POM Product No.
4	KS 4	4	2.9	39	0772 8900 004
5	KS 5	5	3	48	0772 8900 005
6	KS 6	6	4	48	0772 8900 006
12	KS 12	12	8.6	69	0772 8900 012

TRS – Reducing T push-on connectors

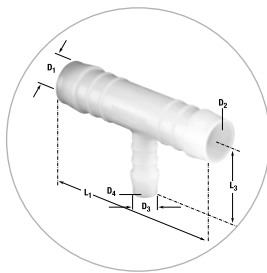

Nominal size ID hose (in mm)	Designation	D ₁	D ₂	D ₃	D ₄	L ₁ ~	L ₄ ~	Material POM Product No.
3 - 4 - 3	TRS 3 - 4 - 3	3	2.5	4	2.5	25	17.5	0761 8903 004
4 - 6 - 4	TRS 4 - 6 - 4	4	2.7	6	4	37	24	0761 8904 006
6 - 4 - 6	TRS 6 - 4 - 6	6	4	4	2.5	49	20.5	0761 8906 004
8 - 4 - 8	TRS 8 - 4 - 8	8	5.6	4	2.5	56	22	0761 8908 004
8 - 6 - 8	TRS 8 - 6 - 8	8	5.6	6	4	56	28	0761 8908 006
8 - 12 - 8	TRS 8 - 12 - 8	8	5.6	12	8.6	57	34	0761 8908 012
10 - 6 - 10	TRS 10 - 6 - 10	10	7	6	4	62	28	0761 8910 006
10 - 8 - 10	TRS 10 - 8 - 10	10	7	8	5.6	62	31	0761 8910 008
10 - 13 - 10	TRS 10 - 13 - 10	10	7	13	8.6	64	38	0761 8910 013
12 - 6 - 12	TRS 12 - 6 - 12	12	8.6	6	4	69	29	0761 8912 006
12 - 8 - 12	TRS 12 - 8 - 12	12	8.6	8	5.6	69	31	0761 8912 008
12 - 10 - 12	TRS 12 - 10 - 12	12	8.6	10	7	69	33	0761 8912 010
15 - 6 - 15	TRS 15 - 6 - 15	15	11	6	4	78	28	0761 8915 006
15 - 8 - 15	TRS 15 - 8 - 15	15	11	8	5.6	79	33	0761 8915 008
18 - 10 - 18	TRS 18 - 10 - 18	18	14	10	7	79	36	0761 8918 010
18 - 15 - 18	TRS 18 - 15 - 18	18	14	15	11	80	44	0761 8918 015

YRS – Reducing Y push-on connectors

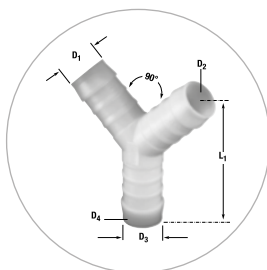

Nominal size ID hose (in mm)	Designation	D ₁	D ₂	D ₃	D ₄	L ₁ ~	Material POM Product No.
4 - 6 - 4	YRS 4 - 6 - 4	4	2.7	6	4	35	0771 8904 006
6 - 8 - 6	YRS 6 - 8 - 6	6	4	8	5.6	49	0771 8906 008

NORMAPLAST®

WS – Elbow push-on connectors

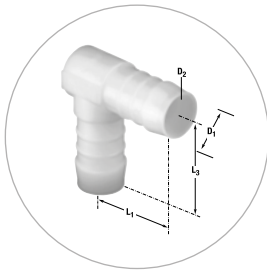

Nominal size ID hose (in mm)	Designation	D ₁	D ₂	L ₁ ~	L ₃ ~	Material POM Product No.
3	WS 3	3	2.5	12.5	12.5	0762 8900 003
4	WS 4	4	2.5	17.5	19.5	0762 8900 004
5	WS 5	5	3	21	22	0762 8900 005
6	WS 6	6	4	25	26	0762 8900 006
8	WS 8	8	5.6	29	30	0762 8900 008
10	WS 10	10	7	31	33.5	0762 8900 010
12	WS 12	12	8.6	34.5	36	0762 8900 012
13	WS 13	13	8.6	36.5	38.5	0762 8900 013
14	WS 14	14	10	38.5	41.5	0762 8900 014
15	WS 15	15	11	40	43.5	0762 8900 015
16	WS 16	16	12	40.5	45	0762 8900 016
19	WS 19	19	15	43.5	46	0762 8900 019
25	WS 25	25	21	52.5	52.5	0762 8900 025

YS – Equal Y push-on connectors

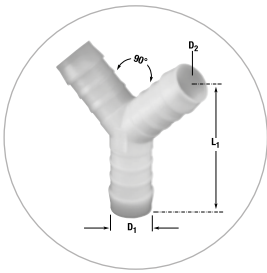

Nominal size ID hose (in mm)	Designation	D ₁	D ₂	L ₁ ~	Material POM Product No.
3	YS 3	3	2.5	21	0770 8900 003
4	YS 4	4	2.5	25.5	0770 8900 004
5	YS 5	5	3	43	0770 8900 005
6	YS 6	6	4	44	0770 8900 006
8	YS 8	8	5.6	51	0770 8900 008
10	YS 10	10	7	54	0770 8900 010
12	YS 12	12	8.6	64	0770 8900 012
13	YS 13	13	9	65	0770 8900 013
14	YS 14	14	10	65	0770 8900 014
16	YS 16	16	12	67	0770 8900 016
19	YS 19	19	15	72	0770 8900 019

GN – Straight plastic pipe connectors

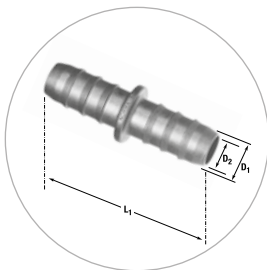

Nominal size ID PA tube (in mm)	Designation	D ₁	D ₂	L ₁ ~	Material PAG -GF30* Product No.	Material PA12-GF20* Product No.	Material PA12-GF30* Product No.
6	GN 6	6.4	4.75	45			0750 8200 006
8	GN 8	9.2	6.8	46	0750 8074 008		
10	GN 10	11	8	46	0750 8300 010		0750 8200 010
15	GN 15	16.9	12	32		0750 8001 015	
19	GN 19	21	16	39		0750 8001 019	
27	GN 27	29	24	42		0750 8001 027	
27 - 19	GRN 27 - 19	29 - 21	24 - 16	44		0751 8045 000	

* Glass fiber content

TN – T plastic pipe connectors

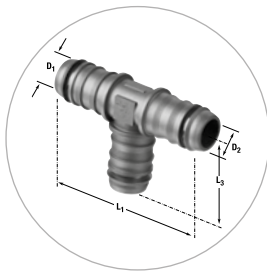

Nominal size ID PA tube (in mm)	Designation	D ₁	D ₂	L ₁ ~	L ₃ ~	Material PA6 -GF30* Product No.	Material PA66-GF30* Product No.	Material PA12-GF30* Product No.
4	TN 4	4.6	2.5	43	23	0760 8129 004		
6	TN 6	6.4	4.75	56.5	28.5	0760 8202 006	0760 8203 006	0760 8200 006
8	TN 8	9.2	6.8	58	29	0760 8112 008		0760 8200 008
10	TN 10	11	8	60	30			0760 8200 010
15	TN 15	16.4	12	72	36			0760 8200 015
19	TN 19	18.9	16	65	32.5			0760 8201 019
15-8-15	TN 15-8-15	16.4-8.9-16.4	12-6-12	72	35			0761 8052 000
15-12-15	TN 15-12-15	16.4-13.5-16.4	12-10.5-12	72	35.5			0761 8015 012

* Glass fiber content

WN – Elbow plastic pipe connectors

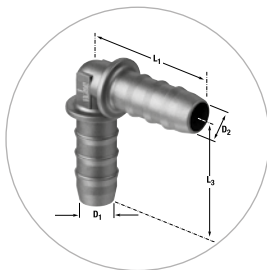

Nominal size ID PA tube (in mm)	Designation	D ₁	D ₂	L ₁ ~	L ₃ ~	Material PA6 -GF30* Product No.	Material PA66-GF30* Product No.	Material PA12-GF30* Product No.
6	WN 6	6.4	4.75	28	28		0762 8205 006	0762 8200 006
8	WN 8	9.2	6.8	29	29	0762 8067 008		0762 8200 008
10	WN 10	11	8	30	30	0762 8201 010		0762 8200 010
19	WN 19	18.9	16	32	32			0762 8200 019

* Glass fiber content

YN – Y plastic pipe connectors

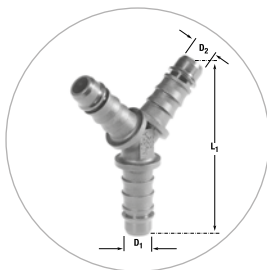

Nominal size ID PA tube (in mm)	Designation	D ₁	D ₂	L ₁ ~	Material PA66-GF30* Product No.	Material PA12-GF20* Product No.	Material PA12-GF30* Product No.
8	YN 8	8.4	5.8	50.5	0770 8203 008		0770 8200 008
10	YN 10	11	8	80			0770 8200 010
15	YN 15	14.9	12	49.3			0770 8200 015
19	YN 19	18.9	16	85		0770 8201 019	

* Glass fiber content

NORMAPLAST®

EG – Straight compression connectors



Nominal size ID PA tube (in mm)	Designation	D ₁	D ₂	L ₁ ~	SW	Diameter	Material PA12-GF30* Product No.
6	EG 6 x 1-R 1/8	6 x 1	R 1/8 con.	25	13	6 x 1-R 1/8	0780 8900 001
	EG 6 x 1-R 1/4	6 x 1	R 1/4 con.	31	17	6 x 1-R 1/4	0780 8900 002
	EG 6 x 1-M10 x 1	6 x 1	M10 x 1 con.	25	13	6 x 1-M10 x 1	0780 8900 003
8	EG 8 x 1-R 1/8	8 x 1	R 1/8 con.	25	13	8 x 1-R 1/8	0780 8900 021
	EG 8 x 1-R 1/4	8 x 1	R 1/4 con.	31	17	8 x 1-R 1/4	0780 8900 022
	EG 8 x 1-M10 x 1	8 x 1	M10 x 1 con.	25	13	8 x 1-M10 x 1	0780 8900 023

* Glass fiber content

EWS – Swivel elbow compression connectors



Nominal size ID PA tube (in mm)	Designation	D ₁	D ₂	L ₁ ~	L ₂ ~	L ₃ ~	SW	Material PAG-GF30* Product No.
6	EWS 6 x 1-R 1/8	6 x 1	R 1/8	14	21	30	13	0780 8901 001
	EWS 6 x 1-R 1/4	6 x 1	R 1/4	15	23	33.5	17	0780 8901 002
	EWS 6 x 1-M10 x 1	6 x 1	M10 x 1	14	21	30	13	0780 8901 003
8	EWS 8 x 1-R 1/8	8 x 1	R 1/8	14	21	30	13	0780 8901 021
	EWS 8 x 1-R 1/4	8 x 1	R 1/4	15	23	33.5	17	0780 8901 022
	EWS 8 x 1-M10 x 1	8 x 1	M10 x 1	14	21	30	13	0780 8901 023

* Glass fiber content

ETS – Swivel T compression connectors

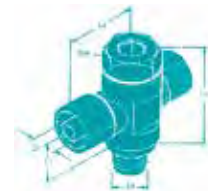

Nominal size ID PA tube (in mm)	Designation	D ₁	D ₂	L ₁ ~	L ₂ ~	L ₃ ~	SW	Material PAG-GF30* Product No.
6	ETS 6 x 1-R 1/8	6 x 1	R 1/8	14	21	30	13	0780 8902 001
	ETS 6 x 1-R 1/4	6 x 1	R 1/4	15	23	33.5	17	0780 8902 002
	ETS 6 x 1-M10 x 1	6 x 1	M10 x 1	14	21	30	13	0780 8902 003
8	ETS 8 x 1-R 1/8	8 x 1	R 1/8	15	23	33.5	17	0780 8902 021

* Glass fiber content

ET – T compression connectors



Nominal size ID PA tube (in mm)	Designation	D ₁	D ₂	L ₁ ~	L ₂ ~	Material PA6-GF30* Product No.
6	ET 6 x 1-R 1/8	6 x 1	R 1/8 con.	19	23	0780 8904 001
	ET 6 x 1-R 1/4	6 x 1	R 1/4 con.	23	23	0780 8904 002
	ET 6 x 1-M10 x 1	6 x 1	M10 x 1 con.	19	23	0780 8904 003
8	ET 8 x 1-R 1/8	8 x 1	R 1/8 con.	19	23	0780 8904 021
	ET 8 x 1-R 1/4	8 x 1	R 1/4 con.	23	23	0780 8904 022
	ET 8 x 1-M10 x 1	8 x 1	M10 x 1 con.	19	23	0780 8904 023

* Glass fiber content

EW/WV – Elbow compression connectors



Nominal size ID PA tube (in mm)	Designation	D ₁	D ₂	L ₁ ~	L ₂ ~	Material PA6-GF30* Product No.
6	EW 6 x 1 - R 1/8	6 x 1	R 1/8 con.	19	23	0780 8905 001
	EW 6 x 1 - R 1/4	6 x 1	R 1/4 con.	23	23	0780 8905 002
	EW 6 x 1 - M10 x 1	6 x 1	M10 x 1 con.	19	23	0780 8905 003
8	EW 8 x 1 - R 1/8	8 x 1	R 1/8 con.	19	23	0780 8905 021
	EW 8 x 1 - R 1/4	8 x 1	R 1/4 con.	23	23	0780 8905 022
	EW 8 x 1 - M10 x 1	8 x 1	M10 x 1 con.	19	23	0780 8905 023
	WV 8 x 1	8 x 1	8 x 1	23	23	0781 8900 011

* Glass fiber content

VT/VTR – Equal T and reducing T compression connectors



Nominal size ID PA tube (in mm)	Designation	D ₁	D ₂	L ₁ ~	L ₂ ~	Material PA6-GF30* Product No.
N/A	VT 6 x 1	6 x 1	6 x 1	23	23	0781 8900 001
	VT 8 x 1	8 x 1	8 x 1	23	23	0781 8900 002
	VTR 6 x 1-8 x 1-6 x 1	6 x 1	8 x 1	23	23	0781 8900 021
	VTR 8 x 1-6 x 1-8 x 1	8 x 1	6 x 1	23	23	0781 8900 022

* Glass fiber content

VG/VGR – Straight/Reducing compression connectors

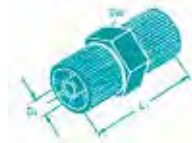

Nominal size ID PA tube (in mm)	Designation	D ₁	L ₁ ~	SW	Material PA6-GF30* Product No.
N/A	VG 6 x 1	6 x 1	31	17	0781 8901 003
	VG 8 x 1	8 x 1	31	17	0781 8901 002
	VGR 8 x 1 - 6 x 1	6 x 1	31	17	0781 8901 004

* Glass fiber content



NORMA

NORMACCLAM® TORRO®

W2

www.normagroup.com

4-6,5mm	18 g.
10-12,5mm	20 g.
16-17,5mm	22 g.
20-22,5mm	25 g.
24-26,5mm	28 g.
30-32,5mm	32 g.

NORMA

NORMA

NORMA

A wide range of assortments, displays, dispenser and tools.

NORMA assortments section offers the possibility of having several clamp diameters in one package. All the accessories and the tools mentioned in this chapter are proposed to enable simple and easy installation of the NORMA products.



NORMAFIX® NORMETTA® Mini repair kits



NORMAFIX® NORMETTA® MINI REPAIR KITS					
Width	Designation	Length in m	Number of closures	Closure type	W1 Product No.
5	MINI REPAIR KIT 8/5	8	8	NB-A5	0560 8520 003
9	MINI REPAIR KIT 8/9	8	8	NB-A9	0560 8520 001

NORMACLAMP® Quick lock Band-on-roll



NORMACLAMP® QUICK LOCK BAND-ON-ROLL					
Width	Designation	Length in m	Number of closures	W2 Product No.	W4 Product No.
9	BAND-ON-ROLL 3M	3	8	0815 7121 001	0815 7131 001
	BAND-ON-ROLL 5M	5	8	0815 7121 003	0815 7131 003
12	BAND-ON-ROLL 3M	3	6	0815 6007 002	
	BAND-ON-ROLL 5M	5	6	0815 6007 004	

ASSORTMENTS

NORMACLAMP® TORRO® Assortment type 120 pcs



NORMACLAMP® TORRO ASSORTMENT TYPE 120 PCS					
Width	Designation	Clamping range	Quantity	W1 Product No.	W4 Product No.
9	TORRO 8 - 16/9	8 - 16	40	0126 5005 012	0126 5005 014
	TORRO 12 - 22/9	12 - 22	25		
	TORRO 16 - 27/9	16 - 27	20		
	TORRO 20 - 32/9	20 - 32	15		
	TORRO 25 - 40/9	25 - 40	10		
	TORRO 35 - 50/9	35 - 50	10		
NA	FLEXIDRIVER	NA	1		

NORMAPLAST® Assortment type 365 PA 6 and TORRO® W2



NORMAPLAST® ASSORTMENT TYPE 365 PA 6 AND TORRO W2				
Width	Designation	Diameter	Quantity	PA 6 W2 (TORRO) Product No.
NA	GS 4	4	50	0773 9000 365
	TS 4	4	50	
	YS 4	4	50	
	GS 6	6	25	
	TS 6	6	25	
	YS 6	6	25	
	GS 8	8	20	
	TS 8	8	10	
	YS 8	8	10	
	GRS 8 - 6	8	20	
7.5	TORRO 8 - 12/7.5	8 - 12	40	
	TORRO 10 - 16/7.5	10 - 16	40	

NORMACLAMP® COBRA kit type 500k

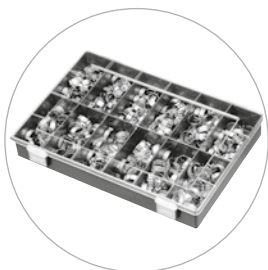

This workshop range is a clearly arranged collection of the most commonly used types of NORMACLAMP® COBRA hose clips in a practical plastic case (approx. 34x23x5 cm).

A workshop range comprises 500 NORMACLAMP® COBRA hose clips made from stainless steel nickel chromium steel and with band widths of 7 mm and 8 mm as follows:

NORMACLAMP® COBRA KIT TYPE 500K				
Width	Designation	Diameter	Quantity	W4 Product No.
7	COBRA 7.5/7	7.5	30	0773 9000 500
	COBRA 8/7	8	25	
	COBRA 8.5/7	8.5	25	
	COBRA 9/7	9	25	
	COBRA 9.5/7	9.5	25	
	COBRA 10/7	10	25	
	COBRA 10.5/7	10.5	25	
	COBRA 11/7	11	25	
	COBRA 11.5/7	11.5	25	
8	COBRA 12/8	12	25	
	COBRA 13/8	13	30	
	COBRA 14/8	14	30	
	COBRA 15/8	15	30	
	COBRA 16/8	16	30	
	COBRA 17/8	17	30	
	COBRA 18/8	18	30	
	COBRA 19/8	19	30	
	COBRA 20/8	20	30	
	COBRA 21/8	21	30	

ASSORTMENTS

NORMAFIX® RSGU 90 Pipe retaining clips assortment



NORMAFIX® RSGU 90 PIPE RETAINING CLIPS ASSORTMENT

Width	Designation	Diameter	Quantity	W1 Product No.
15	RSGU 4/15	4	10	0825 0304 001
	RSGU 6/15	6	10	
	RSGU 9/15	9	10	
	RSGU 10/15	10	10	
	RSGU 12/15	12	10	
	RSGU 13/15	13	10	
	RSGU 15/15	15	5	
	RSGU 16/15	16	5	
	RSGU 18/15	18	5	
	RSGU 20/15	20	5	
	RSGU 22/15	22	5	
	RSGU 25/15	25	5	

NORMAFIX® RSGU ASS-1N100 RSGU W1



NORMAFIX® ASS-1N100 RSGU W1

Width	Designation	Diameter	Quantity	W1 Product No.
12	RSGU1. 8/12	8	20	0941 1000 001
	RSGU1. 10/12	10	20	
	RSGU1. 12/12	12	10	
	RSGU1. 13/12	13	10	
	RSGU1. 14/12	14	10	
	RSGU1. 15/12	15	10	
	RSGU1. 16/12	16	10	
	RSGU1. 20/12	20	10	

NORMAQUICK® PLAST® Assortment



NORMAPLAST® NORMA QUICK PLAST ASSORTMENT

Designation	Quantity	PA 6 Product No.
NQS NW 8-6 0°	3	0700 2011 000
NQS NW8-6 90°	3	
NQS NW10-8-0°	3	
NQS NW10-8-90°	3	
NQS NW1/4"-1/4"-0°	3	
NQS NW1/4"-1/4"-90°	3	
NQS NW5/16"-06-0°	3	
NQS NW5/16"-06-90°	3	
ADAPTER NQS 5/16"-6-0°	3	
NQS NW3/8"5/16-0°	3	
NQS NW3/8"-5/16-90°	3	
ADAPTER NQSNW3/8"-5/16"-0°	3	
GS 6	5	
TS 6	5	
GS 8	5	
TS 8	5	
GS 10	5	
TS 10	5	

NORMACLAMP® TORRO® Dispenser



NORMACLAMP® TORRO DISPENSER				
Width	Designation	Clamping range	Quantity	W2 Product No.
7.5	TORRO 8 - 12/7.5	8 - 12	10	0126 9702 010
9	TORRO 8 - 16/9	8 - 16	10	
	TORRO 12 - 22/9	12 - 22	10	
	TORRO 16 - 27/9	16 - 27	10	
	TORRO 20 - 32/9	20 - 32	10	
	TORRO 25 - 40/9	25 - 40	10	
	TORRO 32 - 50/9	32 - 50	10	
	TORRO 40 - 60/9	40 - 60	10	
	TORRO 50 - 70/9	50 - 70	10	
	TORRO 60 - 80/9	60 - 80	10	

NORMACLAMP® TORRO® Drawer box



NORMACLAMP® TORRO DRAWER BOX				
Width	Designation	Clamping range	Quantity	W2 Product No.
9	TORRO 8 - 16/9	8 - 16	155	0126 9702 450
	TORRO 12 - 22/9	12 - 22	60	
	TORRO 16 - 27/9	16 - 27	100	
	TORRO 20 - 32/9	20 - 32	50	
	TORRO 25 - 40/9	25 - 40	50	
	TORRO 32 - 50/9	32 - 50	15	
	TORRO 50 - 70/9	50 - 70	20	

NORMACLAMP® TORRO® Pallet



NORMACLAMP® TORRO PALLET					
Width	Designation	Clamping range	Quantity	W1 Product No.	W4 Product No.
9	TORRO 8 - 16 /9	8 - 16	40	0126 5006 012	0126 5006 015
	TORRO 12 - 22/9	12 - 22	25		
	TORRO 16 - 27/9	16 - 27	20		
	TORRO 20 - 32/9	20 - 32	15		
	TORRO 25 - 40/9	25 - 40	10		
	TORRO 35 - 50/9	35 - 50	10		
NA	FLEXIDRIVER	NA	1		

NORMACLAMP® TORRO® NHC 420 W1 Merchandiser



NORMACLAMP® NHC420 W1 MERCHANDISER				
Width	Designation	Clamping range	Quantity	W1 Product No.
9	TORRO 8 - 12/9	8 - 12	50	0825 0300 039
	TORRO 10 - 16/9	10 - 16	50	
	TORRO 12 - 22/9	12 - 22	50	
12	TORRO 16 - 27/12	16 - 27	40	
	TORRO 20 - 32/12	20 - 32	30	
	TORRO 25 - 40/12	25 - 40	40	
	TORRO 30 - 45/12	30 - 45	40	
	TORRO 35 - 50/12	35 - 50	40	
	TORRO 40 - 60/12	40 - 60	30	
	TORRO 50 - 70/12	50 - 70	20	
	TORRO 70 - 90/12	70 - 90	10	
	TORRO 80 - 100/12	80 - 100	10	
TORRO 90 - 110/12	90 - 110	10		

NORMACLAMP® TORRO® NHC 420 W3 Merchandiser



NORMACLAMP® NHC 420 W3 MERCHANDISER				
Width	Designation	Clamping range	Quantity	W3 Product No.
7.5	TORRO 8 - 12/9	8 - 12	50	0825 0300 040
9	TORRO 10 - 16/9	10 - 16	50	
	TORRO 12 - 22/9	12 - 22	50	
12	TORRO 16 - 27/12	16 - 27	40	
	TORRO 20 - 32/12	20 - 32	30	
	TORRO 25 - 40/12	25 - 40	40	
	TORRO 30 - 45/12	30 - 45	40	
	TORRO 35 - 50/12	35 - 50	40	
	TORRO 40 - 60/12	40 - 60	30	
	TORRO 50 - 70/12	50 - 70	20	
	TORRO 70 - 90/12	70 - 90	10	
	TORRO 80 - 100/12	80 - 100	10	
TORRO 90 - 110/12	90 - 110	10		

NORMACLAMP® TORRO® NHC 420 W4 Merchandiser



NORMACLAMP® NHC420 W4 MERCHANDISER				
Width	Designation	Clamping range	Quantity	W4 Product No.
9	TORRO 8 - 12/9	8 - 12	50	0825 0300 049
	TORRO 10 - 16/9	10 - 16	50	
	TORRO 12 - 20/9	12 - 20	50	
12	TORRO 16 - 27/12	16 - 27	40	
	TORRO 20 - 32/12	20 - 32	30	
	TORRO 25 - 40/12	25 - 40	40	
	TORRO 30 - 45/12	30 - 45	40	
	TORRO 35 - 50/12	35 - 50	40	
	TORRO 40 - 60/12	40 - 60	30	
	TORRO 50 - 70/12	50 - 70	20	
	TORRO 70 - 90/12	70 - 90	10	
	TORRO 80 - 100/12	80 - 100	10	
TORRO 90 - 110/12	90 - 110	10		

NORMACLAMP® TORRO® NHC 135 W1 Merchandiser



NORMACLAMP® NHC135 W1 MERCHANDISER				
Width	Designation	Clamping range	Quantity	W1 Product No.
9	TORRO 8 - 12/9	8 - 12	20	0825 0300 006
	TORRO 10 - 16/9	10 - 16	20	
	TORRO 12 - 22/9	12 - 22	20	
12	TORRO 16 - 27/12	16 - 27	15	
	TORRO 20 - 32/12	20 - 32	15	
	TORRO 25 - 40/12	25 - 40	15	
	TORRO 35 - 50/12	35 - 50	15	
	TORRO 40 - 60/12	40 - 60	15	

NORMACLAMP® TORRO® NHC 135 W3 Merchandiser



NORMACLAMP® NHC135 W3 MERCHANDISER				
Width	Designation	Clamping range	Quantity	W3 Product No.
7.5	TORRO 10 - 16/7.5	10 - 16	20	0825 0300 008
9	TORRO 8 - 16/9	8 - 16	20	
	TORRO 12 - 20/9	12 - 20	20	
12	TORRO 16 - 27/12	16 - 27	15	
	TORRO 20 - 32/12	20 - 32	15	
	TORRO 25 - 40/12	25 - 40	15	
	TORRO 35 - 50/12	35 - 50	15	
	TORRO 40 - 60/12	40 - 60	15	

NORMACLAMP® TORRO® NHC 135 W4 Merchandiser



NORMACLAMP® NHC135 W4 MERCHANDISER				
Width	Designation	Clamping range	Quantity	W4 Product No.
9	TORRO 8 - 12/9	8 - 12	20	0825 0300 010
	TORRO 8 - 16/9	8 - 16	20	
	TORRO 12 - 22/9	12 - 22	20	
12	TORRO 16 - 27/12	16 - 27	15	
	TORRO 20 - 32/12	20 - 32	15	
	TORRO 25 - 40/12	25 - 40	15	
	TORRO 35 - 50/12	35 - 50	15	
	TORRO 40 - 60/12	40 - 60	15	

**NORMACLAMP® TORRO®
NHC 190 W1 Merchandiser**



NORMACLAMP® NHC190 W1 MERCHANDISER				
Width	Designation	Clamping range	Quantity	W1 Product No.
9	TORRO 8 - 12/9	8 - 12	10	0825 0300 059
	TORRO 10 - 16/9	10 - 16	10	
	TORRO 12 - 22/9	12 - 22	10	
12	TORRO 16 - 27/12	16 - 27	10	
	TORRO 20 - 32/12	20 - 32	10	
	TORRO 25 - 40/12	25 - 40	10	
	TORRO 30 - 45/12	30 - 45	10	
	TORRO 35 - 50/12	35 - 50	10	
	TORRO 40 - 60/12	40 - 60	10	
	TORRO 50 - 70/12	50 - 70	10	
	TORRO 60 - 80/12	60 - 80	10	
	TORRO 70 - 90/12	70 - 90	10	
	TORRO 80 - 100/12	80 - 100	10	
	TORRO 90 - 110/12	90 - 110	10	
	TORRO 100 - 120/12	100 - 120	10	
TORRO 110 - 130/12	110 - 130	10		
TORRO 120 - 140/12	120 - 140	10		
TORRO 130 - 150/12	130 - 150	10		
TORRO 140 - 160/12	140 - 160	10		

**NORMACLAMP® TORRO®
NHC 190 W3 Merchandiser**



NORMACLAMP® NHC190 W3 MERCHANDISER				
Width	Designation	Clamping range	Quantity	W3 Product No.
7.5	TORRO 8 - 12/9	8 - 12	10	0825 0300 060
9	TORRO 8 - 16/9	8 - 16	10	
	TORRO 12 - 20/9	12 - 20	10	
12	TORRO 16 - 27/12	16 - 27	10	
	TORRO 20 - 32/12	20 - 32	10	
	TORRO 25 - 40/12	25 - 40	10	
	TORRO 30 - 45/12	30 - 45	10	
	TORRO 35 - 50/12	35 - 50	10	
	TORRO 40 - 60/12	40 - 60	10	
	TORRO 50 - 70/12	50 - 70	10	
	TORRO 60 - 80/12	60 - 80	10	
	TORRO 70 - 90/12	70 - 90	10	
	TORRO 80 - 100/12	80 - 100	10	
	TORRO 90 - 110/12	90 - 110	10	
	TORRO 100 - 120/12	100 - 120	10	
TORRO 110 - 130/12	110 - 130	10		
TORRO 120 - 140/12	120 - 140	10		
TORRO 130 - 150/12	130 - 150	10		
TORRO 140 - 160/12	140 - 160	10		

NORMAEXTRA

NORMACLAMP® TORRO® NHC 190 W4 Merchandiser



NORMACLAMP® NHC190 W4 MERCHANDISER				
Width	Designation	Clamping range	Quantity	W4 Product No.
9	TORRO 8 - 12/9	8 - 12	10	0825 0300 061
	TORRO 10 - 16/9	10 - 16	10	
	TORRO 12 - 20/9	12 - 20	10	
12	TORRO 16 - 27/12	16 - 27	10	
	TORRO 20 - 32/12	20 - 32	10	
	TORRO 25 - 40/12	25 - 40	10	
	TORRO 30 - 45/12	30 - 45	10	
	TORRO 35 - 50/12	35 - 50	10	
	TORRO 40 - 60/12	40 - 60	10	
	TORRO 50 - 70/12	50 - 70	10	
	TORRO 60 - 80/12	60 - 80	10	
	TORRO 70 - 90/12	70 - 90	10	
	TORRO 80 - 100/12	80 - 100	10	
	TORRO 90 - 110/12	90 - 110	10	
	TORRO 100 - 120/12	100 - 120	10	
TORRO 110 - 130/12	110 - 130	10		
TORRO 120 - 140/12	120 - 140	10		
TORRO 130 - 150/12	130 - 150	10		
TORRO 140 - 160/12	140 - 160	10		

NORMACLAMP® GBS M75 Merchandiser W1, W2 & W4



NORMACLAMP® GBSM75 MERCHANDISER W1, W2 & W4						
Width	Designation	Clamping range	Quantity	W1 Product No.	W2 Product No.	W4 Product No.
18	GBS 18/18	18	4	0825 0301 002	0825 0301 000	0825 0301 001
	GBS 22/18	22	4			
	GBS 28/18	28	4			
	GBS 30/18	30	4			
	GBS 33/18	33	4			
	GBS 36/18	36	4			
	GBS 39/18	39	4			
	GBS 42/18	42	4			
20	GBS 45/20	45	4			
	GBS 49/20	49	4			
	GBS 53/20	53	4			
	GBS 57/20	57	4			
	GBS 61/20	61	4			
	GBS 66/20	66	4			
25	GBS 71/25	71	4			
	GBS 76/25	76	3			
	GBS 82/25	82	3			
	GBS 88/25	88	3			
	GBS 108/25	108	3			
	GBS 117/25	117	3			

NORMACLAMP® Quick lock Band-on-roll dispenser



NORMACLAMP® QUICK LOCK BAND-ON-ROLL DISPENSER				
Width	Designation	Length in m	W2 Product No.	W4 Product No.
9	BAND-ON-ROLL 3M	3	0815 5007 015	0815 5007 014
	BAND-ON-ROLL 5M	5	0815 5007 017	0815 5007 016

NORMACLAMP® TORRO® Assembly fixture



NORMACLAMP® TORRO® ASSEMBLY FIXTURE

Designation	Product No.
ASSEMBLY FIXTURE	0126 9900 001

NORMACLAMP® COBRA Pneumatic pliers

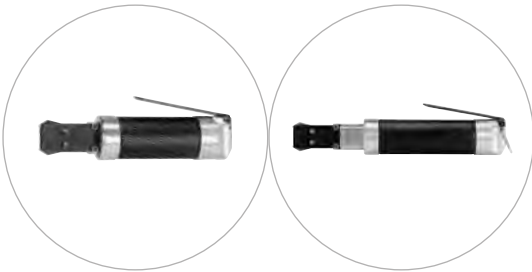

These pneumatically assisted pliers are available in a short version, and a long version, and are the ideal installation tool for industrial applications, allowing serial installation work involving large quantities to be handled with ease.

NORMACLAMP® COBRA PNEUMATIC PLIERS

Designation	Product No.
COBRA PNEUMATIC PLIERS	0110 8420 010

NORMACLAMP® FBS Pneumatic pliers

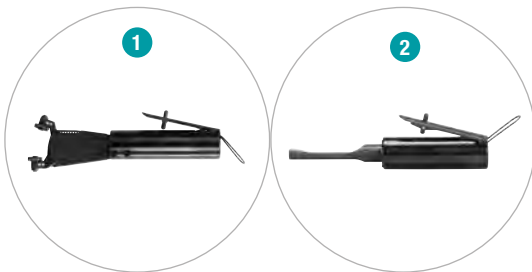

- Version S**
Suitable for “vertical” assembly operations where the clamp head is approached from above. Ideal for high volume series assembly.
- Version W**
Suitable for “horizontal” assembly operations where the clamp head is approached from the side. For high volume series assembly.

NORMACLAMP® FBS PNEUMATIC PLIERS TYPE S

Designation	Product No.
FBS PNEUMATIC PLIERS TYPE S	0115 0000 911*1
FBS PNEUMATIC PLIERS TYPE S	0115 0000 912*2

NORMACLAMP® FBS PNEUMATIC PLIERS TYPE W

Designation	Product No.
FBS PNEUMATIC PLIERS TYPE W	0115 0000 919*1
FBS PNEUMATIC PLIERS TYPE W	0115 0000 920*2

*1 jaws are opened before release

*2 jaws are closed before release

NORMACLAMP® FBS C Multirelease tool



For unlocking pre-opened FBS C, only our release tool is permitted.

NORMACLAMP® FBS C MULTIRELEASE TOOL

Designation	Product No.
FBS C MULTIRELEASE TOOL	0115 0000 936

NORMACONNECT® FGR Fitting pliers belt for REP E



NORMACONNECT® FGR FITTING PLIERS BELT FOR REP E

Designation	Product No.
FITTING PLIERS FOR DIAMETER 38 - 168.3	0573 8000 007
FITTING PLIERS FOR DIAMETER 180 - 1200	0575 8000 049

NORMAFIX® Cable tie pliers



2.2 to 4.8 mm



4.8 to 7.8 mm



3.6 mm to 13 mm



3.6 mm to 9 mm

NORMAFIX® CABLE TIE PLIERS FROM 2.2 TO 4.8 MM

Designation	Product No.
PLIERS FOR CABLE TIE FROM 2.2 TO 4.8 MM	0860 1000 001

NORMAFIX® CABLE TIE PLIERS FROM 4.8 TO 7.8 MM

Designation	Product No.
PLIERS FOR CABLE TIE FROM 4.8 TO 7.8 MM	0860 1000 004

NORMAFIX® CABLE TIE PLIERS FROM 3.6 TO 13 MM

Designation	Product No.
PLIERS FOR CABLE TIE 0860 FROM 3.6 TO 13 MM	0860 1000 005

NORMAFIX® CABLE TIE PLIERS FROM 3.6 TO 9 MM

Designation	Product No.
PLIERS FOR CABLE TIE 0860 FROM 3.6 TO 9 MM	0860 1000 006

NORMAFIX® NORMETTA® Clamping and cutting tool



This high quality cast tool is recommended for professional work. Easy to use, it provides a tensile force of approximately 10,000 N (1000 KP).

NORMAFIX® NORMETTA CLAMPING AND CUTTING TOOL

Designation	Product No.
CLAMPING AND CUTTING TOOL	0560 8555 001

NORMACLAMP® Earclip pliers



NORMACLAMP® EARCLIP PLIERS

Designation	Product No.
EARCLIP PLIERS END CLOSING	0819 0022 094
EARCLIP PLIERS SIDE CLOSING	0819 0022 095

NORMACLAMP® Earclip pliers for flat mounting



NORMACLAMP® EARCLIP PLIERS FOR FLAT MOUNTING

Designation	Product No.
EARCLIP PLIERS FOR FLAT MOUNTING	0819 022 161

NORMACLAMP® COBRA Handheld pliers

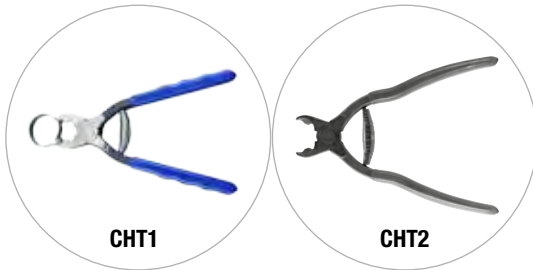

These handheld pliers enable precise installation and removal. The tips of the pliers' head enable a secure grip on the clip's tool gripping points. The integrated smooth-running spring element keeps the pliers open continuously, allowing you to work quickly and comfortably.

NORMACLAMP® COBRA CHT 1

Designation	Product No.
COBRA CHT 1	0110 8420 000

NORMACLAMP® COBRA CHT 2

Designation	Product No.
COBRA CHT 2	0110 8420 004

NORMACLAMP® FBS Handheld pliers

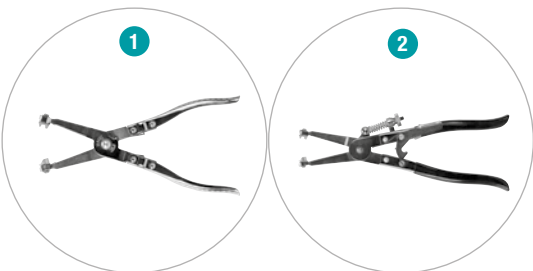

For professional installation of FBS clamps, two types of handheld pliers are available depending on the band width involved:

- 1 Type1: for small nominal diameters.
- 2 Type 2: for all diameters, with integrated safety lever for fixing the pliers in position.

NORMACLAMP® FBS PLIERS

Designation	Product No.
FBS PLIERS	0115 0000 903

NORMACLAMP® FBS PLIERS WITH INTEGRATED SAFETY LEVER

Designation	Product No.
FBS PLIERS WITH INTEGRATED SAFETY LEVER	0115 0000 904

NORMACLAMP® TORRO® Screwdriver SW6, SW7, SW6/7



NORMACLAMP® TORRO® SCREWDRIVER SW6, SW7, SW6/7

Designation	Product No.
SW6	0000 0000 899
SW7	0000 0000 898
SW6/7	0000 0000 894

NORMACLAMP® Hi-torque T-screwdriver



NORMACLAMP® HI-TORQUE T-SCREWDRIVER

Designation	Product No.
T-SCREWDRIVER FOR HI-TORQUE CLAMP	0560 6600 001

NORMAFIX® Tube clamp fittings Hexagonal key



NORMAFIX® HEXAGONAL KEY

Designation	Diameter in mm	Galvanized steel Product No.
HEXAGONAL KEY 26.9/33.7	26.9/33.7	0819 6332 001
HEXAGONAL KEY 42.4/48.3/60.3	42.4/48.3/60.3	0819 6332 002

NORMAFIX® Tube clamp fittings Aluminum end cap



NORMAFIX® ALUMINUM END CAP

Designation	Diameter in mm	Aluminum Product No.
ALUMINIUM END CAP 33.7	33.7	0819 6329 034
ALUMINIUM END CAP 42.4	42.4	0819 6329 042
ALUMINIUM END CAP 48.3	48.3	0819 6329 048

NORMAFIX® Tube clamp fittings Plastic end cap



NORMAFIX® PLASTIC END CAP

Designation	Diameter in mm	Plastic Product No.
PLASTIC END CAP 33.7	33.7	0819 6330 034
PLASTIC END CAP 42.4	42.4	0819 6330 042
PLASTIC END CAP 48.3	48.3	0819 6330 048

NORMAFIX® Tube clamp fittings Spare screws



NORMAFIX® SPARE SCREW

Designation	Diameter in mm	Stainless steel Product No.
SPARE SCREW 26.9/33.7	26.9/33.7	0819 6331 001
SPARE SCREW 42.4/48.3/60.3	42.4/48.3/60.3	0819 6331 002

NORMAFIX® Lamppost protection tape



NORMAFIX® LAMPOST PROTECTION TAPE

Designation	Length in m	PVC Product No.
BLACK EPDM PROTECTION TAPE ROLL OF 10 METERS	10	0560 7640 010
WRAP & SEAL VULCANIZING STRETCHABLE TAPE TAPE - BLACK 2.4 METERS	2.4	0560 7640 002
WRAP & SEAL VULCANIZING STRETCHABLE TAPE TAPE - BLACK 4.8 METERS	4.8	0560 7640 004

NORMAFIX® Cable tie Wall plug bases for cable tie

For fixing cables and pipes to walls. Very easy installation for cable ties up to 9 mm width.



NORMAFIX® WALL PLUG BASES FOR CABLE TIES

Designation	PA 6.6		
	White	Black	Grey
	Product No.	Product No.	Product No.
WALL PLUG BASES FOR CABLE TIES WITHOUT FINS 8 MM BASE	0860 0701 002	0860 0701 001	
WALL PLUG BASES FOR CABLE TIES WITH FINS 6 MM BASE	0860 0701 112	0860 0701 111	0860 0703 111
WALL PLUG BASES FOR CABLE TIES WITH FINS 8 MM BASE	0860 0701 102	0860 0701 101	0860 0703 101

NORMAFIX® Cable tie Mounting bases for cable tie

For fixing cables and pipes to walls. Very easy installation for cable ties up to 9 mm width.



NORMAFIX® MOUNTING BASES FOR CABLE TIES WITHOUT ADHESIVE

Number of entrances	Designation	For cable ties band width	Dimensions (mm)					PA 6.6	
			A	B	C	F	H	White	Black
			Product No.	Product No.					
1	MOUNTING BASES FOR CABLE TIES WITHOUT ADHESIVE 3.6	3.6	19	19	4.2	4	5	0860 0811 001	0860 0812 001
	MOUNTING BASES FOR CABLE TIES WITHOUT ADHESIVE 4.8	4.8	27	27	4.2	6	7.4	0860 0811 002	0860 0812 002
2	MOUNTING BASES FOR CABLE TIES WITHOUT ADHESIVE 3.6	3.6	19	19	4.1	4	5	0860 0911 001	0860 0912 001
	MOUNTING BASES FOR CABLE TIES WITHOUT ADHESIVE 4.8	4.8	27	27	4.8	6	6.5	0860 0911 002	0860 0912 002

NORMAFIX® MOUNTING BASES FOR CABLE TIES WITH ADHESIVE

Number of entrances	Designation	For cable ties band width	Dimensions (mm)					PA 6.6	
			A	B	C	F	H	White	Black
			Product No.	Product No.					
1	MOUNTING BASES FOR CABLE TIES WITH ADHESIVE 3.6	3.6	19	19	4.2	4	5	0860 0831 001	0860 0832 001
	MOUNTING BASES FOR CABLE TIES WITH ADHESIVE 4.8	4.8	27	27	4.2	6	7.4	0860 0831 002	0860 0832 002
2	MOUNTING BASES FOR CABLE TIES WITH ADHESIVE 3.6	3.6	19	19	4.1	4	5	0860 0931 001	0860 0932 001
	MOUNTING BASES FOR CABLE TIES WITH ADHESIVE 4.8	4.8	27	27	4.8	6	6.5	0860 0931 002	0860 0932 002



NORMA – User information

Installation instructions

To obtain the most performance out of our products, we ask you to read through the following chapter User Information. Learn about the system requirements and how to make the installation most effective.



System requirements for



Spigot and bead

- Sufficient spigot strength required
- As smooth a surface as possible
- As round as possible
- No longitudinal grooves
- As little mismatch in mold as possible



Mismatch in mold

Hose

- Inner diameter of hose must be smaller than outer diameter of spigot. The smaller the hose used with the spigot concerned, the higher the push-on and pull-off force coverage. 0.5 mm to 1.5 mm should be aimed for (in relation to the diameter).
- Wall thickness as low as possible
- As round as possible
- Low relaxation properties
- No requirements relating to outer diameter tolerance
- No longitudinal grooves on inner diameter
- Lining reinforcement positioned as uniformly as possible in hose material
- Shore hardness not too low, in order to prevent damage to hose

The precise tolerance levels for the wall thickness and inner diameter are stated in the DIN 3017 specifications for heavy-duty clamps.

Bead

- The higher the bead, the higher the pull-off and installation force
- The lower the bead, the lower the pull-off and installation force

Angle change as per **1**
= lower pull-off forces

Angle change as per **2**
= higher pull-off forces

Angle change as per **3**
with specified bead length b
= easy installation,
low installation forces,
low pull-off forces

Angle change as per **3**
with specified bead diameter a
= easier installation,
similar installation force,
same pull-off forces

Angle change as per **4**
= opposite result



Installation information for



Selecting the clamp

- Take the clamping diameter into consideration; in all cases, it must be possible to install the clamp on the hose.
- The correct band width must be selected with the system parameters taken into consideration.
- The material that is appropriate for the clamp must be selected with the corrosion conditions taken into consideration.
- Any potential thermal loads must be taken into consideration.
- Any potential mechanical loads must be taken into consideration.

Note:

The system pressure must be taken into account as well. However, the clamp must not be considered in isolation in this respect; instead, the entire system must be made to work together in a way that delivers optimum performance.

Professional installation

- The clamp must be installed in as central a position as possible on the junction piece.
- The clamp must be installed at an angle.
- The clamp should be tightened as slowly as possible.
- The recommended tightening torque is based on the results of testing and should be adhered to.
- If the clamp is tightened beyond the recommended tightening torque, the pull-off force and sealing ability of the clamp will not increase proportionally in relation to the torque that is applied.
- If the test torque is exceeded, there is a risk of permanent damage to the clamp and the system (e.g., failure of the clamp during re-installation).
- It may be advisable to re-tighten the connection once, 1–5 minutes after it has been installed for the first time (bear in mind the aging behavior of the hose).*
- Water or a mixture of water and alcohol should be used to help the installation process. We do not advise using lubricants such as soap suds, greases or similar substances.

- It must be possible to attach the installation tool to the clamp at an angle.
- Ideally, for safety reasons we recommend using a hexagon installation tool or an open-ended tool.

* Only applies to NORMACLAMP®TORRO® and NORMACLAMP®GBS

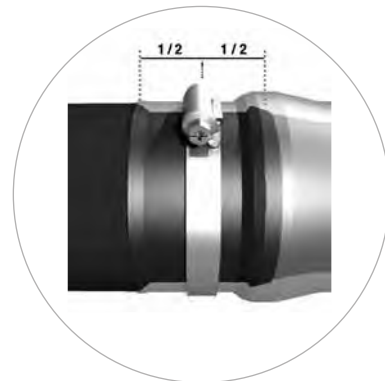

Central installation shown using the example of a NORMACLAMP®TORRO®

Technical glossary

Tightening torque

The tightening torque describes the recommended torque which should be used to tighten a worm drive clamp. In most cases this is the torque that is specified by DIN 3017. It is very easy to measure this torque using a torque wrench.

It is important to note that, in addition to the structure of the clamp (form closure), the band tensile force (clamping force) is chiefly responsible for the sealing properties of a hose clamp connection. The level of this force can only be determined explicitly as a numerical value using appropriate measuring devices. Indirect methods such as measuring the pull-off force or burst pressure of certain connections may be used for comparative purposes. This means that the band tensile force (clamping force) of a clamp cannot be determined directly on the basis of the clamp tightening torque. Therefore, it is necessary to use appropriate structural measures in order to keep the spread of this clamping force to a minimum when a particular tightening torque is applied. This will ensure the components installed are appropriately secure and maintain the connection's sealing properties.

At NORMA Group, we are able to measure these band tensile forces precisely. We draw up band tensile force diagrams in which we enter the initial tightening torque converted into the band tensile force directly as a means of measuring efficiency levels. This allows us to determine the efficiency of the clamp being measured. This data is represented in the band tensile force specification at the nominal torque.

A higher band tensile force at the nominal torque will produce a more effective hose clamp!

Band tensile force

The band tensile force is the level which produces optimum mechanical adhesion and sealing properties in a particular connection (consisting of a hose, spigot and clamp). (See also the information under "Tightening torque.")

As part of the ongoing development of TORRO® products, the clamps have been optimized so that particularly high band tensile forces can be achieved.

Failure and destruction torque

The failure or destruction torque denotes the torque that has to be applied to the clamp in order to destroy it. Like the test torque, this torque provides an indication of how robust the clamp is and is viewed as particularly significant in the commercial vehicle sector, as torque tools are not always available for installing or removing clamps in service. In this kind of scenario, installing hose clamps simply based on what feels correct (rather than using precise tools) must not result in damage to the clamps.

A high failure or destruction torque means a high level of robustness.

Idling torque

The idling torque refers to the torque that is required for turning a screw/bolt without generating clamping force. An extremely low idling torque and little spread create the ideal conditions for making the clamp easy to handle during installation.

Test torque

The test torque, which is usually around 30% above the tightening torque, denotes the torque that can be applied to the clamp without causing permanent damage to it.

A high test torque means a high level of robustness.

Installation Notice Hi-Torque Clamp



- 1** Slide the loop onto the band in the direction of the arrow and push around the casing.

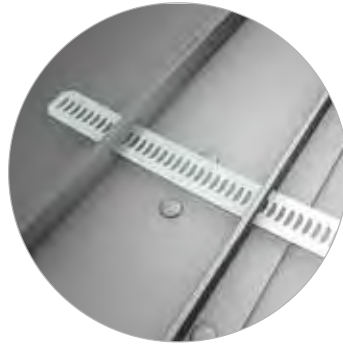

- 2** Insert the band through the flange slots and around the post.



- 3** Engage the band in the casing and screw the band through to approx. 50mm.



- 4** Slide any excess band under the loop.



- 5** Tighten the band using an appropriate tool.



- 6** Your hi torque clamp is well installed now. It can be removed and repositioned if necessary.

Installation Notice Compression Fittings

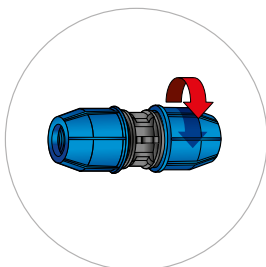

- 1** Unscrew the nut up to the last thread.

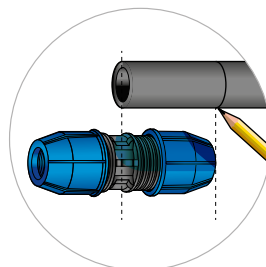

- 2** Cut the pipe and deburr, if necessary, in the insert depth.

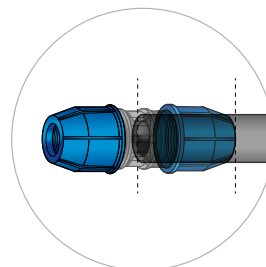

- 3** Push the pipe, without unscrewing the nut, up to the mark. For this, you should push the pipe until reaching the clamping ring and the gasket.

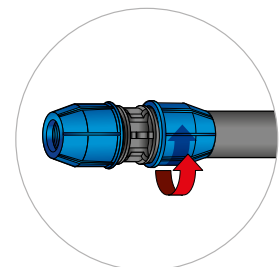

- 4** Screw and tighten the nut firmly. The nut can be tightened manually.

Manual installation of Cable Ties



1 Insert the tip of the tie.



2 Tighten the tie manually until complete fixation of the cables.



3 Avoid sharp bending of the tie. This will not improve the fixing strength.



4 Cut the excess part of the tie with a few millimeters of safety length.

Tool installation of standard Cable Ties



1 Set the max. tension of the tool depending on the size of the tie.



2 Grip the tie with the tool.

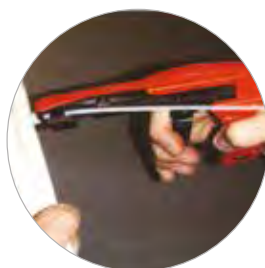

3 Tighten the tie until complete fixation of the cables.



4 Cut off the excess part of the tie.

Installation Plastic Hose Connectors

Pipe dimensions: Outer diameter - 2x wall thickness

Push the cap onto the pipe; push the pipe onto the sleeve as far as it will go; tighten the cap on the buttress thread as much as possible (using standard pliers if necessary).

Cap also available as an individual part.

Before tightening the cap

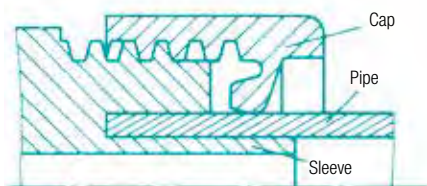

After tightening the cap

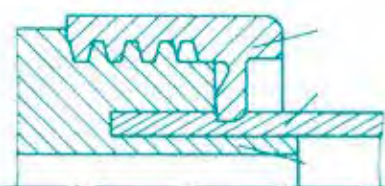

Cap screwed on as far as it will go.



NOTES

A series of horizontal dotted lines for writing notes, spanning the width of the page.



NOTES

A series of horizontal dotted lines for writing notes, spanning the width of the page.

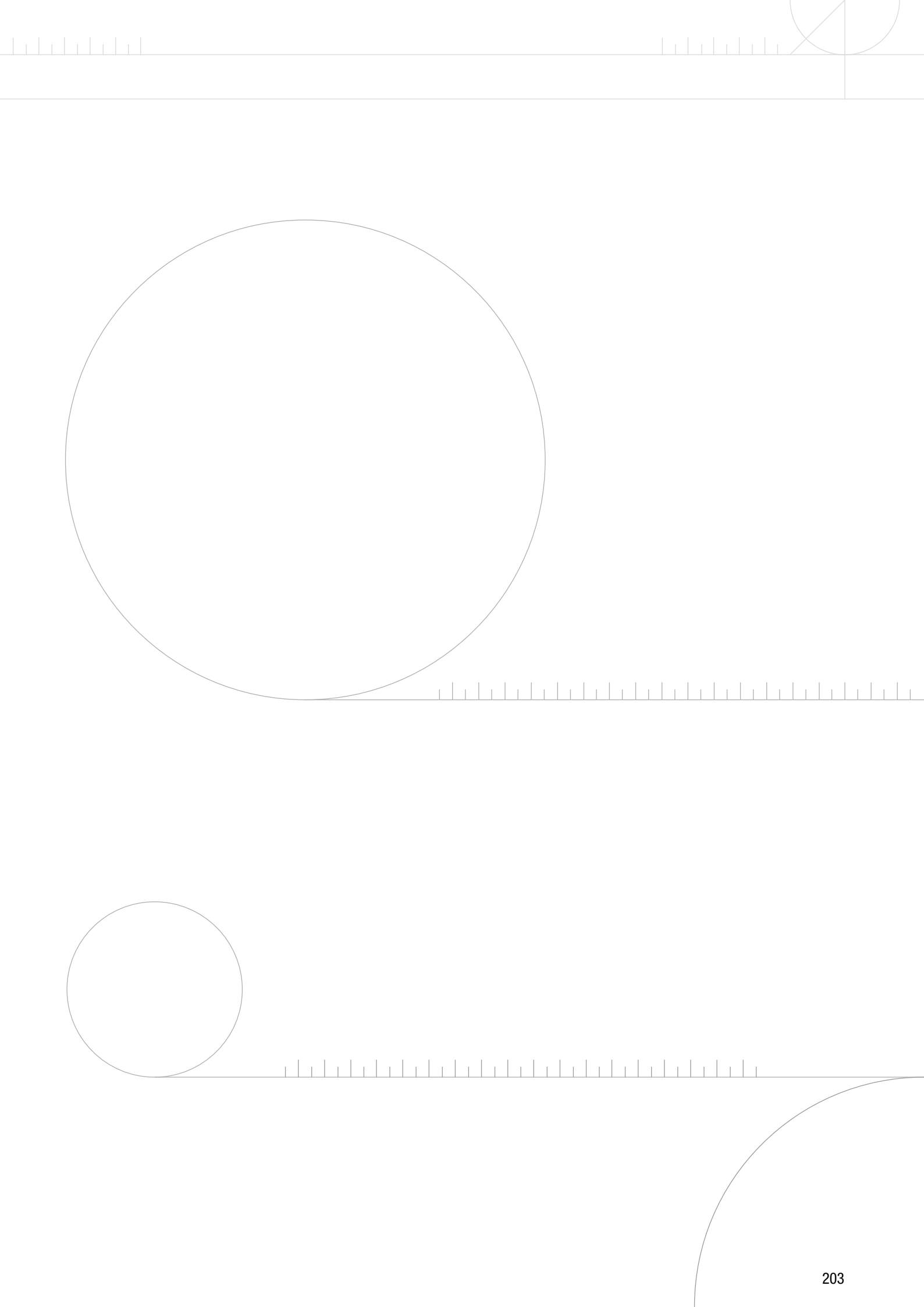

NORMA®

NORMACLAMP®

NORMACONNECT®

NORMAFIX®

NORMAPLAST®

are registered trademarks of NORMA Germany GmbH.

NORMA Group

Postfach 11 49 · D-63461 Maintal

Edisonstraße 4 · D-63477 Maintal

Tel: +49 (61 81) 4 03-0

Fax: +49 (61 81) 4 03-210

www.normagroup.com

info@normagroup.com



This catalogue supersedes all previous issues. No part of this publication may be reproduced without our prior written consent. In NORMA Group's policy of continual product improvements to meet user needs and technological developments, all models and sets listed in this folder (photographs, specifications, sizes and weights) may be upgraded or discontinued without notice and without any obligation on our part to modify tools or equipment sold previously. The recommendations for use and safety given in this folder do not replace accepted good practice or the safety related legal and regulatory provisions. References to standards implemented as of March 11, 2016 are not contractually binding.

